

Polish Academy of Sciences  
University of Engineering and Economics in Rzeszów  
University of Life Sciences in Lublin  
Faculty of Production Engineering

# MOTROL

**COMMISSION OF MOTORIZATION AND ENERGETICS  
IN AGRICULTURE**

AN INTERNATIONAL JOURNAL  
ON OPERATION OF FARM  
AND AGRI-FOOD INDUSTRY MACHINERY

Vol. 17, No 8

LUBLIN – RZESZÓW 2015

**Editor-in-Chief:** *Eugeniusz Krasowski*

**Assistant Editor:** *Jerzy Grudziński*

#### **Associate Editors**

1. Agricultural machinery: *Dmytro Voytiuk*, Kiev, *Mariusz Szymanek*, Lublin
2. Machinery of agri-food industry: *Leszek Mościcki*, Lublin
3. Energetics: *Iliia Nikolenko*, Simferopol, *Janusz Wojdalski*, Warszawa
4. Land management, urban planning, construction, architecture and geodesy: *Mykhailo Sukach*, *Karol Noga*, Kraków, *Roman Kadaj*, Rzeszów, *Michał Proksa*, Rzeszów, *Lech Lichołaj*, Rzeszów
5. Mathematical, statistics: *Andrzej Kornacki*, Lublin, *Rostislav Bun*, Lviv

#### **Editorial Board**

<i>Dariusz Andrejko</i> , Lublin, Poland	<i>Jaromir Mysłowski</i> , Szczecin, Poland
<i>Andrzej Baliński</i> , Kraków, Poland	<i>Ignacy Niedziółka</i> , Lublin, Poland
<i>Volodymyr Bulgakow</i> , Kiev, Ukraine	<i>Stanislaw Nikolajenko</i> , Kiev, Ukraine
<i>Zbigniew Burski</i> , Lublin, Poland	<i>Paweł Nosko</i> , Lugansk, Ukraine
<i>Karol Cupiał</i> , Częstochowa, Poland	<i>Gennadij Oborski</i> , Odessa, Ukraine
<i>Aleksandr Dashchenko</i> , Odessa, Ukraine	<i>Yurij Osenin</i> , Lugansk, Ukraine
<i>Kazimierz Dreszer</i> , Lublin, Poland	<i>Marian Panasiewicz</i> , Lublin, Poland
<i>Konstantin Dumenko</i> , Mykolayiv, Ukraine	<i>Sergiy Pastushenko</i> , Mykolayiv, Ukraine
<i>Dariusz Dziki</i> , Lublin, Poland	<i>Vitaliy Ploskiy</i> , Kiev, Ukraine
<i>Stepan Epoyan</i> , Kharkiv, Ukraine	<i>Iwan Rohowski</i> , Kiev, Ukraine
<i>Jan Gliński</i> , Lublin, Poland	<i>Zinovii Ruzhylo</i> , Kiev, Ukraine
<i>Dimitriy Goncharenko</i> , Kharkiv, Ukraine	<i>Vjacheslav Shebanin</i> , Mykolayiv, Ukraine
<i>Janusz Grzelka</i> , Częstochowa, Poland	<i>Povilas A. Sirvydas</i> , Kaunas, Lithuania
<i>Aleksandr Holubenko</i> , Lugansk, Ukraine	<i>Volodymyr Snitynskiy</i> , Lviv, Ukraine
<i>L.P.B.M. Jonssen</i> , Groningen, Holland	<i>Stanisław Sosnowski</i> , Rzeszów, Poland
<i>Stepan Kovalyshyn</i> , Lviv, Ukraine	<i>Henryk Sobczuk</i> , Lublin, Poland
<i>Józef Kowalczyk</i> , Lublin, Poland	<i>Ludvikas Spokas</i> , Kaunas, Lithuania
<i>Volodymyr Kravchuk</i> , Kiev, Ukraine	<i>Andrzej Stępniewski</i> , Lublin, Poland
<i>Petro Kulikov</i> , Kiev, Ukraine	<i>Aleksandr Sydorchuk</i> , Kiev, Ukraine
<i>Elżbieta Kusińska</i> , Lublin, Poland	<i>Beata Ślaska-Grzywna</i> , Lublin, Poland
<i>Andrzej Kusz</i> , Lublin, Poland	<i>Wojciech Tanaś</i> , Lublin, Poland
<i>Janusz Laskowski</i> , Lublin, Poland	<i>Giorgiy F. Tayanowski</i> , Minsk, Bielarus
<i>Kazimierz Lejda</i> , Rzeszów, Poland	<i>Leonid Tishchenko</i> , Kharkiv, Ukraine
<i>Jerzy Merkiś</i> , Poznań, Poland	<i>Denis Viesturs</i> , Ulbrok, Latvia
<i>Jarosław Mykhajlovych</i> , Kiev, Ukraine	<i>Anatolij Yakovenko</i> , Odessa, Ukraine
<i>Janusz Mysłowski</i> , Szczecin, Poland	<i>Tadeusz Złoto</i> , Częstochowa, Poland

All the articles are available on the webpage: <http://www.pan-ol.lublin.pl/wydawnictwa/Teka-Motrol.html>

All the scientific articles received positive evaluations by independent reviewers

Linguistic consultant: *Krishna Kayastha*  
Typeset: *Dmitro Mischuk, Adam Niezbecki*  
Cover design: *Hanna Krasowska-Kołodziej*  
Photo on the cover: *Natalia Zhytariuk*

© Copyright by Polish Academy of Sciences 2015

© Copyright by University of Life Sciences in Lublin 2015

© Copyright by University of Engineering and Economics in Rzeszów 2015

in co-operation with Kyiv National University of Construction and Architecture 2015

#### **Editorial Office address**

Polish Academy of Sciences Branch in Lublin  
Pałac Czartoryskich, Plac Litewski 2, 20-080 Lublin, Poland  
e-mail: [eugeniusz.krasowski@up.lublin.pl](mailto:eugeniusz.krasowski@up.lublin.pl)

#### **Publishing Office address**

KNUCA, Povitroflotskyy prosp., 31, Kyiv, Ukraine, 03680  
e-mail: [motrol@ukr.net](mailto:motrol@ukr.net)

#### **Printing**

PAT VIPOL, Wolynskaja str., 60, Kyiv, Ukraine, 03151  
tel. +38 044 246 2735

ISSN 1730-8658

Edition 100+16 vol.

## Evolution of reforming of the civil construction industry management system in Ukraine

*Sergei Bronevitski*

PhD, Head of municipal enterprise

«Institute of the Master Development Plan of the City of Kyiv».

Hreshchatyk Str., 32, of. 306, Kyiv, Ukraine, 01001, e-mail: bsp@grad.gov.ua

**Summary.** Examined are the problems of the civil construction industry performance. The main shortcomings of the management system scrutinized. The factors had been shaping the Management System of Ukraine Civil Construction Industry revealed. Description is given of elements and mechanisms of management system, advantages and disadvantages “administrative regulation”. Examined are the management technologies of the civil construction industry in the countries of market economy. Examples are given of developing the housing programs in the USA. The summary is given on the mainstream trends in managing the civil construction industry and on areas of optimization of the management system.

**Key words:** construction industry, management, state regulation

### INTRODUCTION

Post-industrial development of the society in XXI century faced the global problems of the territory and power resources scantiness, what turned into a mighty boost for development of innovative technologies in construction industry and stipulated the brand new systematic tasks in management of the construction industry.

The construction branch, in general, bears responsibility for realization of the national economy tasks, which became imminent at a certain stage of social evolution. Solving

these social tasks is the target for the management system of construction industry.

At the present stage of post-industrial development of the society, the main problem is setting the comfortable living environment for population and, at the same time, economic use of tangible material and power resources. This determines the necessity of development of the innovative strategy for reforming the management of the construction industry.

### PURPOSE OF WORK

The information technologies for management of implementation of the innovative projects, the education systems etc., were examined in the works of A.A. Beloshitskiy, S.D. Bushuiev, N.S. Bushuieva, P.P. Lizunova. The authors provided proposals on development of innovative information technologies for designing in the heat and power engineering industry, systems of water supply, as well as in higher education [5].

The administrative aspects of the management system were examined by A. Galchinskiy, V. Gaets, A. Kinakh, V. Seminozhenko [6]. The main emphasis was put on implementation of an “e-government» concept. Meanwhile, the comprehensive analysis of the management system’s evolution of construction industry, in the context with

strategic societies of national economy at a given historical stage, had not been made.

The areas of the housing and public utilities reformation were researched broadly. U. Mantsevich [8] studied the matters of the housing cost reduction, as well as management of the housing resources, problems and prospects of the house building development.

In the writings of A.M. Pleshkanovska and E.D. Savchenko [10] were studied the aspects of construction activities during the various historical eras, the factors of the current building booms emerging, the long-term forecasts for the urban future.

Problems of management system of construction industry reformation, in the context of the strategic tasks of the national economy, efficient mechanisms of management in conditions of the market economy were left with no attention of mentioned studies.

## RESULTS AND EXPLICATION

The dynamics and scale of the building scope as well as the innovations necessary for construction industry, first of all, are anticipated in the master development plans of communities, where are defined demands in scope and quality of buildings and constructions, within the context of general concepts of functional and spatial development.

The key functions of the Master Development Plan of the city are provision of population with housing, social and communal facilities, necessary domestic service facilities; establishment of the optimal system of labor application facilities, first of all, in the public production, as well as in the areas of recreational activities [1, 2].

At present and in the near future, there are two main types of the facilities in the housing construction practice: building of large scopes of quite comfortable, but power-efficient housing for provision of the bulk of the population and building the elite housing.

The first type comprises two categories: business-class housing, which parameters are determined by demands of the middle class economically active population and economy

class housing, corresponding to the requirements of the population with income below the middle level.

A separate place in construction is taken by the facilities of executive class: office and corporate buildings, the unique complexes of socio-cultural purpose – theaters, museums, exhibitions, sports arenas, and large transportation structures – motor roads, high-speed electric transport lines, bridges and overpasses, underground structures, etc.

The tasks of the new system building are quite normalized and limited.

Every listed construction category requires its own managerial models, innovative technological approaches, and organizational practices with substantial difference in parameters of profitability, breakeven and resource intensity [3].

Under the resource-constrained conditions, the emphasis now is on reconstruction of degraded urban areas and development of small-area sites, as a prevailing concept of the volumetric and spatial development of cities.

In this connection, the currency of organization of large site coverage of systematic housing construction with scopes over 3 million sq. m, typical of the previous times, now is almost filed as a history. Place was given to the concept of renewal of the small-block developing of environment with small enclosed courts-patios, instead of the principle of micro-zoning with ‘transfluent’ spaces of residential groups. Establishment of associations of the apartment house co-owners (AAHCW) encourages development of face lifting of housetops and terraces for planting the greenery, what requires innovative technologies.

The management structure of construction industry appeared unprepared to solve all of these tasks.

For understanding the tasks of reformation of the management structure of construction industry, it is necessary to identify the main factors of its shaping in the Soviet planned and command economy period, and at the transition stage of establishment of the mar-



ket economy and management system, after gaining independence by Ukraine.

In the 30's of the past century, the main national problem was solving the tasks of industrialization of the country, what conditioned organization of the branch ministries, specializing in training of personnel for construction industry and provision of the construction basis for developing the enterprises of the staple industry, rail transportation, large waterworks, defense-industrial sector and some other major branches of national economy.

Management of construction in this and later stages of the Soviet period had been always performed with rigidly centralized allocation of the budget, and material and technical resources, accountability of the organizations before overhead organization, under regular periodic and running control.

During the first postwar period, the thorny problem emerged of recovering the ruined infrastructure of the country within the shortest deadlines, what found its logical reflection in the structure of management, establishing the mobile construction trust-sites, bridge construction parties, etc.

Upon completion of the main repairing work in the 50-60's, the displacement of citizens from barracks, basements, and congested shared apartments became the urgent political task. To meet this target, the construction industry had to secure the increasing of the housing construction scope and reduction of construction deadlines, by several times. Solution was found in planning the large residential communities of the mass housing construction and its industrialization. This was the very problem the construction industry's management system was designed to solve.

Under these conditions, the central management agency of the ex-USSR construction industry (Gosstroy USSR) [15] had to secure the uniform technical policies: development and approval of the State construction norms, technical data sheets, standards, typical designs, approvals of design and planning specifications and project estimating procedures, exclusion of, so-called, «excesses» from de-

signs and estimates, all possible construction costs and deadlines reduction

Approvals of individual designs and those of the high-rise buildings were performed by the central agency, meanwhile, application of custom designs if the typical ones were available, was excluded. The system imposed, consisting of the State scientific research and development, and design institutes, as well as the higher education and specialized secondary schools, made sure the development of typical designs of buildings and technical, engineering and production work force development for design and construction organizations in Moscow with branches in Kyiv and administrative centers of some other republics.

The mechanism of command and administrative management of the construction industry shaped in this way was able to perform within the shortest deadlines the mass system construction of large residential districts in all communities of the country.

The Industry-Specific Construction Norms Instruction ISCN 38-82 on composition, development procedures, agreement and approval of layouts and designs of the district planning, planning and development of cities, villages and rural communities, set up the necessary composition of the design and planning specifications: the master development plans of urban and rural communities, designs of detailed planning, layouts of the districts planning. The system of the two-stage design permitted to solve the problem of cost reduction and reduction of design estimates development deadlines.

The technical standards orders CN 531-80 on composition, development procedures and approval of the district heating system layouts for communities with total heat demand at up to 116 MW (100 Gcal/h), directed the construction industry and community facilities of the cities towards construction of large district heat supply sources, having eliminated application of small local boiler plants.

However, yet in the 80's the shortcomings of such a management system became apparent. Moreover, although since 1987 the organizations in the structure of construction

industry were converted into the self-financing ones, this did not provide the opportunities of freedom to take decisions.

Provisions on organization procedures, tasks and functions of the technical supervision teams and the contracted customer/developer of construction site, which defined the functions of the Department of capital construction within the executive boards of municipal councils as integrated construction customer, in fact, had blocked development of the competitive environment in the construction industry.

For solving this particular problem of realization of the uniform technical policy, the central office established divisions of technical rating and standardization, typical designing, organizing design and survey works, estimate rates and pricing in construction industry, structures, and new materials.

Thus, for construction management per branch attribute, within the Gosstroy system were established: the Ministry of special construction and assembly works (Minspetsstroy-montazh) the Ministry of construction, road and community machine engineering (Minstroydormash), the Ministry of railway construction (Mintrans), etc [7].

Minspetsstroy-montazh managed construction and assembly works at the industrial and civil construction sites. Subordinate to the ministry were 224 trusts, 274 industrial enterprises and 37 education establishments for technical engineering and production manpower development for construction organizations, as well as scientific research and design organizations.

Minstroydormash managed the industrial enterprises for design and manufacturing the construction machinery, including concrete-mixing equipment, hoisting machines etc.

Mintrans secured setting the construction basis and work force development for railway construction.

For solving the problems of construction in Siberia, in the Far North and other regions of the country were established the territorial and regional ministries.

In this way, were secured the centralized management of the construction industry per

branch and territorial principles, covering as the stages of district planning and planning the development of urban and rural communities, industrial hubs, as well as design, performing construction, assembly and special works, manufacturing the construction machinery and special types of construction work.

At the same time the strictly centralized allocation of technical and financial resources, running control and regular reporting was maintained for all subdivisions, educational, and design and construction organizations before the overhead organizations [5].

Undoubtedly, the command and administrative principle of centralized management of the construction industry secured solving the large national economic tasks during the corresponding historical period.

Nevertheless, the over-centralized management, leaving no space for freedom to take decisions, impartially promoted development of typical uniform environment, insufficiently took into consideration the historical regional and local peculiarities of urban and rural communities.

It should be noted here, the very important role of implementation of certain forms of construction and assembly organizations for solving the corresponding tasks. The main form of construction and assembly organizations (CAO) were 'trusts' and independent, or composing the 'trust' construction and assembly departments (CADs, CDs, etc.), as well as self-financing stations - the primary independent production units, immediately performing construction operations [6]. All the State plans and allocation of material resources had been prepared for 'trusts'. At the 'trusts' level all the technical and economic planning issues have been decided, as well as contractual relations, process control, preparation for operations.

At the same time, the tendencies remained to pass a range of managerial functions at the higher levels (regional central authority, consortium, concern), the 'trusts' did not include subsidiary production plants, transport facilities, utilities living teams, moreover, general

procurement issues also were completely dependent from the overhead management body.

Depending on the type of contractual relations one may distinguish the General Contracting 'Trusts' and the Subcontracting 'Trusts', moreover, by the type of the jobs performed - there were general construction 'trusts' and the specialized ones.

General construction 'trusts', being the general contractors, were performing the main types of general construction jobs (installation, stonework, concrete, etc.). The specialized 'trusts' were performing, as a rule, one type of job or a set of several similar jobs (foundation engineering, dress work, electric installation, plumbing, etc.). Along with a technological specialization was commonly used the branch specialization by the types of construction, i.e., the 'trusts' of residential, industrial, railway and some other types of construction. Specialized organizations, as a rule, are subcontractors, but sometimes act as general contractors (i.e., 'trusts' of foundation engineering for HCP) or perform the jobs according to the separate contract with a customer.

By the area of activities there may be distinguished the 'trusts'-sites, 'trusts' of urban type, territorial 'trusts'. Let us say, the aforementioned 'trusts'-sites were established for performing the large-scope construction and installation jobs at a site often in industrial construction, at the same time the management of production operations performed through construction stations. The 'trusts' of urban type perform their jobs within the limits of one city, like, say, the 'trust' "Kyivgorstroy" which built, virtually, the whole of postwar Kyiv. Territorial 'trusts' acted within the limits of certain districts. By the scope of construction and installation jobs with consideration of their complexity and labor intensiveness, were distinguished the four groups of construction and installation organizations by emoluments of managerial, and engineering and technical personnel.

During the period of mass system construction, the widespread were also the hous-

ing construction plants (HCP) – an organizational form of association of a construction organization with an industrial enterprise, performing construction operations by industrial practices. A revolutionary innovative approach of this period appeared to be the detailed specification of the construction design series and typification of the series' details. At the same time, HCP were specializing in construction by industrial practices with details of own production (large-panel, apartments' modules, etc.), residential and administrative and public buildings, structures of the certain series, multi-series details production, and, sometimes, in performing the certain types of jobs (installation, fit-out works, etc.) by regular teams.

It is to be noted, that the management structure of construction industry and the forms of construction and installation organizations permitted in due time, to solve a thorny national economic and social problem – provision of the population with economical, industrially erected housing. At the same time, management of the construction industry, as mentioned above, had been performed using the rigid accountability of the subordinate organizations before the overhead ones, agreement of appointment and dismissal of managers, the centralized allocation of financial, and material and technical resources.

Now the automated control of processes productions system at the level of build enterprises, using machines on the industrial building is created [13, 14]. Power and resource-efficient innovative technologies are the main customer of the product of construction industry [1, 9, 12]. Problems of municipal services from the ecological point conditions and possibility of effective power saving up technologies use of view [11], [20].

In the management structure of construction industry the feedback with population, as was totally absent.

In independent Ukraine the State committee of urban planning and architecture was established, transformed later into Gosstroy of Ukraine, since 2004 – into the Ministry of regional development, construction, architec-

ture, and housing and communal services in Ukraine (Fig. 1) [16, 17].

The sphere of regional development regulates the issues of decentralization and those arising from administrative-territorial system.

The issues in the sphere of construction and architecture comprise problems of pricing and expert examination of the regulatory

framework, development of the urban planning paperwork, technical solutions for designs of the high-rise buildings.

The sector of housing and communal services performs preparation of reforms in this sphere.

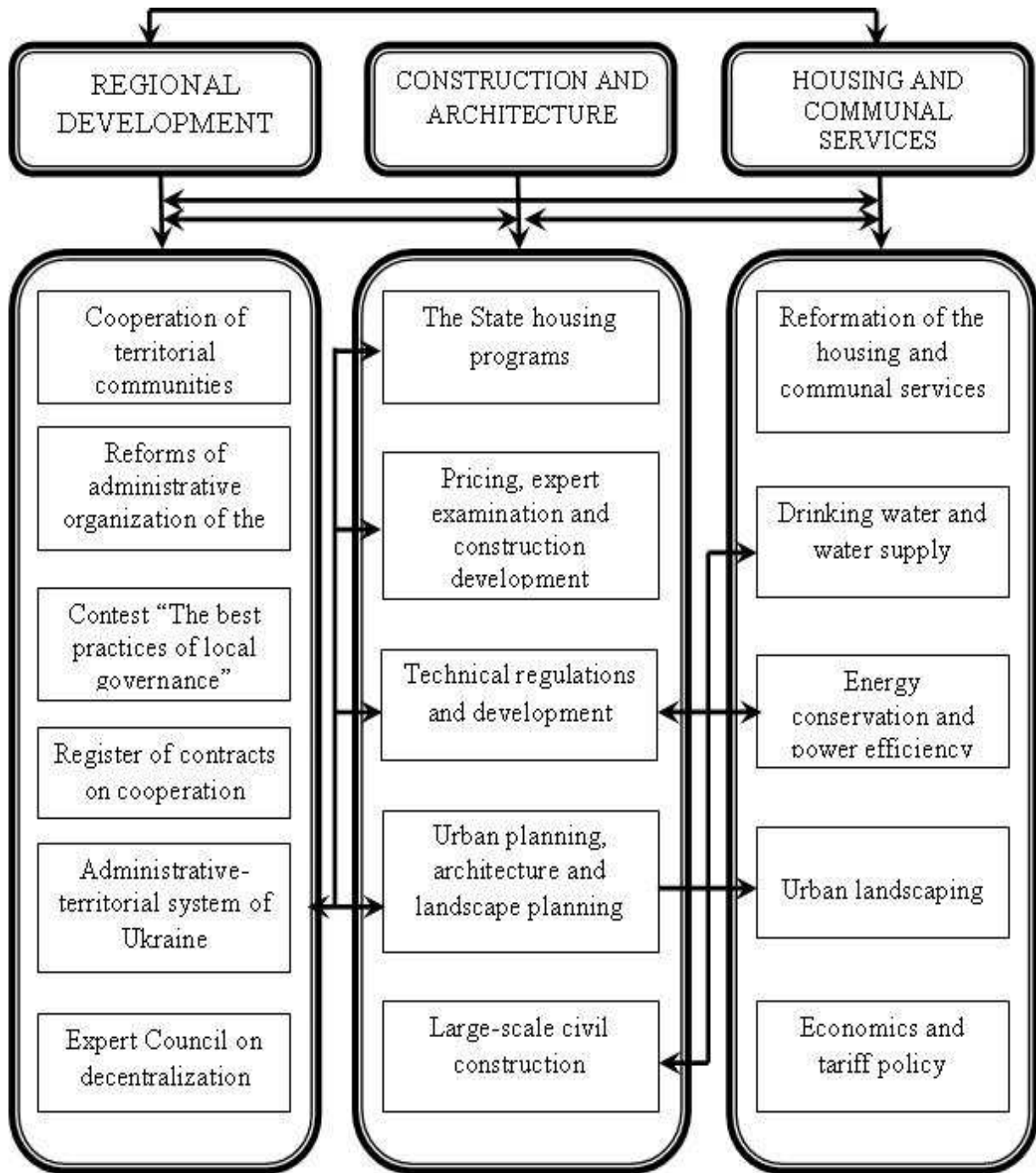

**Fig. 1.** The scope of activities of the Ministry of regional development, construction, architecture and housing and communal services in Ukraine

In this way, the sphere of the Ministry activities, in general, covers the urgent national economy present-day problems [18].

The integrated construction customer service has lost its significance and ceased operation. Accountability of the construction organizations and centralized allocation of financial and technical resources is not required. Does not provide accountability to higher construction companies facing organizations.

The formation of vertical and horizontal linkages is not regulated. Development of construction norms and standards, as well as the urban planning paperwork of the State level is financed centrally. Implementation of the State programs for comprehensive reconstruction of obsolete housing resources, produced by industrial process and construction of the new affordable housing failed. Home loans not hedged against inflation, ticky tacky frauds caused the population's distrust to developers and banks.

The management construction industry mechanisms are limited to consideration of the issues at the ministerial boards and councils' meetings, on the initiative of local architectural bodies or developers (except for drafts of the regulatory documents). The hearing minutes serve as guidelines and are not binding. The system of approval is substantially simplified, approval of the urban planning and design as well as custom design paperwork is cancelled, typical designs are not allowed.

Reporting of local bodies is performed on development issues of urban planning paperwork. The results of consideration are also not binding. The practice of compulsory out-of-town consideration meetings for realization of the master development plans of cities in different districts of Ukraine is forbidden, as well as preparation of reports on development of the urban planning, including analysis of issues on design and construction activities.

The technical policy of the Ministry is implemented through the State norms and national standards, regulating the composition of urban planning and design paperwork, re-

quirements to planning and development of communities, buildings and structures, pricing, requirements on working safety conditions, consumption rates of fuel and energy.

Still, an acute problem is lack of economic and legal mechanism of realization of the master development plans which tasks are not clear to the population. This had led to the excessive politicization of the issues of their development and using by dishonest political opponents as a slogan for their election campaigns, contraposition of the urban building development tasks to the interests of wide circles of population, what had led to increase of construction risks.

There were established the construction organizations - general contractors with their marketing and realty sales structures, but which are not interested economically in development and implementation of innovative technologies. In connection with opportunities of realty sales, yet at the stage of the underground cycle of construction job, are widespread the ticky tacky frauds, what strengthens the population's and construction companies' stand-off.

The postwar period countries with market economy, have also faced the pungent social problems of housing unavailability to all the population strata, prompt solving of the housing problem in critical situations, rehabilitation of degraded urban areas and corresponding tasks in management of construction industry.

For example, the Department of Housing and Urban Development, USA [19], secures financing and administration of realization of a wide variety of nationwide federal programs, related to meeting the demands in housing. At the local level, the zoning plans and detailed plans are being developed, which ensure their tridimensional realization.

The private sector is being encouraged, which is able to secure construction of affordable housing, encouraged are establishment of joint ventures (societies).

The special federal programs were allocated especially to meet the demands in housing of Indians and indigenous residents of Alaska, on recovery of the housing in the

natural disaster stricken districts, etc. There was created a secure legal and financial mechanism of realization the construction programs at the federal and local levels.

In Federal Republic of Germany, the renovation system for the obsolete housing of industrial series was developed and implemented with mobilization of financial resources from the International Bank for Reconstruction and Development.

There are some other good practices of implementation of construction programs, included into urban master development plans.

## CONCLUSIONS AND RECOMMENDATIONS

The management construction system in Ukraine secured freedom to take decisions, but appeared unable to solve the affordability problems of housing for population, implementation of innovative resource-saving technologies, building up reserves of municipal housing resources for prompt resettlement of refugees during emergency situations, etc. Construction organizations appeared to be out of the influence area of central and local managing bodies. There is no comprehensive analysis of construction industry development.

In the absence of financial and economic incentives, construction companies are not interested in implementation of innovations, what conditions low innovative activity.

In the context of stagnation, the systematic problems in construction industry management appeared, namely: excessive construction risks, absence of the system of their hedging and unavailability of credit resources for construction organizations, non-transparency of their financial reporting, large scope of incomplete construction and lack of cash reserves for its completion, rise in the cost of construction (estimated cost), absence of State regulation of the sales price of 1 sq. m with respect to the estimated cost ratio, problems with connection of the houses constructed to utilities supply lines.

Lacking of economic and legal mechanism of the master development plans realization conditioned chaotic nature of development of the cities. The tasks of urban planning paperwork remain obscure for population, regardless of approval of national regulatory documents on conducting the public hearings of the urban planning paperwork.

The facts mentioned above brought to excessive politicization of the master Development plans of cities and their using by dishonest political opponents, as a slogan for their election campaigns. Unjustified construction risks emerged in the construction industry, regardless of the efforts of the State regulation of the processes of “public hearings”.

In connection with opportunities of the realty sales, yet at the stage of the underground cycle of construction job, are widespread the ticky tacky frauds, what strengthens the population’s and construction companies’ stand-off.

The problem mentioned above condition the necessity of reformation for construction industry management system using efficient mechanisms for realization of the housing programs, like, for example, in Federal Republic of Germany, Singapore, etc.

To achieve decentralization and prevent corruption it seems necessary the innovative strategy to be developed for reforming the management of construction industry. It is necessary to foresee in its composition a comprehensive mechanism of realization, including the following:

- the system of hedging the construction and credit risks, benefits and subventions, the ratio of the sales price and estimated cost 1 sq. m,
- regulatory acts and standards, providing for innovative resource-saving policy,
- national programs of provision for housing of various social strata of the population;
- financial mechanism of promoting the innovative technologies in construction industry,
- mechanism of realization of national programs, providing for hedging the home loans, leasing of municipal housing re-

sources, redemption of the housing property right,

- electronic management, securing the anti-corruption policy, popularization of the urban planning paperwork, informing on financial and social benefits for population from realization of the urban planning designs and certain construction sites.

It is preferable to develop the organizations of General Contractors, supervisors of the development projects realization.

In this way, reforming of construction industry management system on the basis of aforementioned main directions, would secure the high social-economic effect from the activities of construction industry.

#### REFERENCES

1. **Bekirs E., Fursina N., 2013.** Environmental characteristics of solar and wind power. MOTROL, 2013, Vol 15, 5, 145-150. (in Russian).
2. **Bronevitskiy S., 2013.** Kyiv Master Plan. The main problems and tasks of building complex. Scientific Production Journal «Construction of Ukraine», 6. LLC "Lazurit-Polygraph", 2-8. (in Ukrainian).
3. **Bronevitskiy S., 2014.** Construction Planning, Scientific Production Journal «Construction of Ukraine», 1. PH "Basis", 2-8. (in Ukrainian).
4. **Bronevitskiy S., 2014.** Planning innovative development of construction sector in Kyiv General plan, «Starodubovskye reading», 1-4. (in Ukrainian).
5. **Bushuyev S., Yaroshenko F., Tanaka H., 2011.** Management of innovative projects and program on the basis of the knowledge system. K P2M, ISBN 978-617-661-010-6, 263. <http://upma.kiev.ua/ru/knigi>. (in Ukrainian).
6. **Galchinskiy A., Gaets V., Kinakh A., Seminozhenko V., 2002.** Innovative strategy of Ukrainian reforms. Kyiv, PH "Knowledge of Ukraine", 336. (in Ukrainian).
7. **Kasatkin V., 1969-1978.** Big Soviet Encyclopaedia. Moskov, Stroyizdat (in Russian).
8. **Mantsevych Y., 2004.** Housing: problems and prospects. Kyiv, Profi. 360. (in Ukrainian).
9. **Nikolenko I., Demkov A., Manuylov M., 2013.** Perspective flowsheet of cleansing buildings of autowashings. MOTROL, 2013, Vol 15, 5, 129-137. (in Russian).
10. **Pleshkanovska A., Savchenko E., 2012.** Cities and epochs. Kyiv, Cybernetics Institute, PH "Logos", 229. (in Ukrainian).
11. **Saliev E., 2013.** Reliability of the functioning of the water supply and sewerage system 2013 MOTROL, Vol 15, 5, 53-60. (in Russian).
12. **Saliev E., 2013.** Ecological and economic problems of power saving up technologies introduction in Ukraine, MOTROL, 2013, Vol 15, 5, 53-60. (in Russian).
13. **Sukach M., Khomenko N., Litvinenko I., 2009.** Optimization of prime price use the build machinesv on industrial objects. MOTROL, 2009, 11B, 190-195. (in Russian).
14. **Sukach M., Litvinenko I., Bondar D., 2009.** Automated control and measuring of parameters of technological processes system. MOTROL, 2009, 11B, 186-189. (in Russian).
15. **Gosstroy of the USSR., 2015.** URL: <https://ru.wi-kikipedia.org/wiki>. (in Russian).
16. **Law of Ukraine "On the basics of urban planning" Verkhovna Rada of Ukraine, Law dated 16.11.1992 Nr. 2780-XII8. 2015.** <http://zakon1.rada.gov.ua/laws/show/2780-12>. (in Ukrainian).
17. **Decree of the President of Ukraine "On Provisions about the State Committee of Ukraine for construction and architecture...(with amendments" dated 05.03.2004), 2015.** URL: [http://search.ligazakon.ua/l\\_doc2.nsf/link1/U633\\_11.html](http://search.ligazakon.ua/l_doc2.nsf/link1/U633_11.html). (in Ukrainian).
18. **Decree of the Cabinet of Ministers of Ukraine of 30 April, 2014 No. 197 "On approval of the Provisions for the Ministry of regional development, construction, architecture, and housing and communal services of Ukraine", 2015.** URL: [http://minregion.gov.ua/attachments/files/pr\\_ministerstvo/polozhen-nya.pdf](http://minregion.gov.ua/attachments/files/pr_ministerstvo/polozhen-nya.pdf). (in Ukrainian).
19. **The Ministry of housing and urban development U.S., 2015.** URL: <https://ru.wikipedia.org/wiki>. (in Russian).
20. **Zaychenko L., Lesnoy A., Popov A., 2013.** Analysis of unaccounted water in the sewerage system. MOTROL, 2013, Vol 15, 5, 61-67. (in Russian).

ЭВОЛЮЦИЯ РЕФОРМИРОВАНИЯ  
СИСТЕМЫ УПРАВЛЕНИЯ  
СТРОИТЕЛЬНЫМ КОМПЛЕКСОМ  
В УКРАИНЕ

**Аннотация.** Рассмотрены проблемы деятельности строительного комплекса и основные недостатки системы управления. Выявлены факторы, формировавшие систему управления строительным комплексом в Украине, а также преимущества и недостатки административного механизма управления. Приведена современная структура системы управления

строительной отраслью в Украине. Раскрыты технологии управления строительным комплексом в странах с рыночной экономикой. Показаны примеры формирования жилищных программ в США. Сделаны выводы об основных направлениях управления строительным комплексом и механизмах оптимизации системы управления.

**Ключевые слова:** строительный комплекс, система управления, государственное регулирование.



## Principles and strategies of sustainable development of regions

*Iryna Ustinova*

Kyiv National University of Construction and Architecture  
Povitroflotskyy prosp., 31, Kyiv, Ukraine, 03680, e-mail: i-ust@mail.ru

**Summary.** To determine the principles and strategies of sustainable development the analysis of general trends in human development in eco-physical sense of this phenomenon were made. The following concepts were considered: ethnogenesis, ecosystem autoregulation, demographic and dynamics of urban development. The comparative analysis of general trends in ethnic-, eco-, demo- and urbosystem testified that based thermodynamic model, results in successive changes of phases and phase transitions. The notions of ethnic homeostasis", "stable population" and "balance in urban areas" expose the essence of the phenomenon of "ecological balance" in public and environment interaction. The considered development is an oscillatory process, where the criterion of "best" is excluded, where only the rhythm of change conditions, with more or less intensity, speed and capacity development exist. It is established that the regularity of self-regulation defines the development of urban areas as the environmental and urban systems. In this regard the development of these areas is purposeful and predictable and therefore is a manageable process with a given goal – the sustainable development in a range of ecological balance. The equilibrium is described by a ratio of 1:1 between population size and demographic capacity of the territory.

**Key words:** sustainable development, self-regulation ecosystem, ecological balance, demographic capacity, environmental and town-planning system.

### INTRODUCTION

The achievements of conditions of sustainability of environmentally sound devel-

opment, after the UN Conference on Environment, gained the characteristics of guiding humanitarian activities of the international community. The problem is actual for Ukraine, where the depopulation is taking place along with the further growth of urban areas. Today the sustainable development is generally interpreted by the definition, provided in the report of the UN Commission of the Environment "Our common future" (H. Brundlandt, 1989): "... is a development that allows to ensure steady economic growth for long-term basis and that does not lead to degradation changes in the environment; the access to the level of sustainable development designed to meet the needs of both current and future generations ..." [1, p. 4]. The economic orientation of the modern ideology of sustainability is defined from the abovementioned. However, there is another opinion.

According to the "Limits to Growth" (D. Meadows, 1972) – first report for "the Roman club", the world development is defined differently at different stages. Firstly - by the established quantitative growth of system's parameters (population, consumption of natural resources that is not renewed, food and commodity industries, pollution), then – by a global resource crisis and the inertia period of population growth in a worsening economic and environmental crises, and as likely result – a global demographic collapse. The conclusion of the report is warning mankind about environmental constraints of

economic growth because of the limits of growth and the need to support (in these limits) of global equilibrium, which is possible only after stabilization ("zero" growth) of population and capital [2].

And here the difficulties begin, because the terminological ambiguity of the concept essence of "sustainability" nullifies the efforts of management in this area. As we know from physics, some definitions have made a great change to the meaning of this theory. Enough to remember the famous example of "simultaneity" definition in classical physics and relativity. Ambiguity in the concept of "sustainability" (quantitative growth – development within certain limits) is a consequence of the modern state in science, where a change of paradigm thinking takes pace. In this respect, the Director of the Institute of European Environmental Policy Ulrich von Vaytzeker notes that "we live on the eve of a new paradigm, so the economic paradigm will soon give way to environmental one" [3, p.27]. The ecological crisis of depletion of planet resources makes the international community to abandon the quantitatively oriented economic paradigm of our time, which comes from the desire to increase consumption of as many people as possible and move to environmental, quality oriented paradigm which is based on the

need to ensure the survival of humanity as a biological species in an environment that is influenced by his activities and life support functions which due to depletion of natural resources may be inadequate with the needs and possibilities of adaptation [3-5].

The status defined in the social sciences of the early twenty first century resembles the situation in physics of the early twentieth century when there was a change of its conceptual frameworks and classical physics was complemented by quantum one. In these conditions the finding of appropriate conceptual foundations of the adoption of national and regional sustainable development programs becomes very important. To determine the required principles and strategies the comparative analysis of general trends of ecophysical development of ethnic, environmental, demographic and urban systems of various levels of hierarchical integrity was conducted.

## MATERIALS AND METHODS

The aim of the study is to develop a methodology for urban management for sustainable development of the territory. The method of analogy was used as the base, which allows not to experiment with the system, a part of which is the man himself.

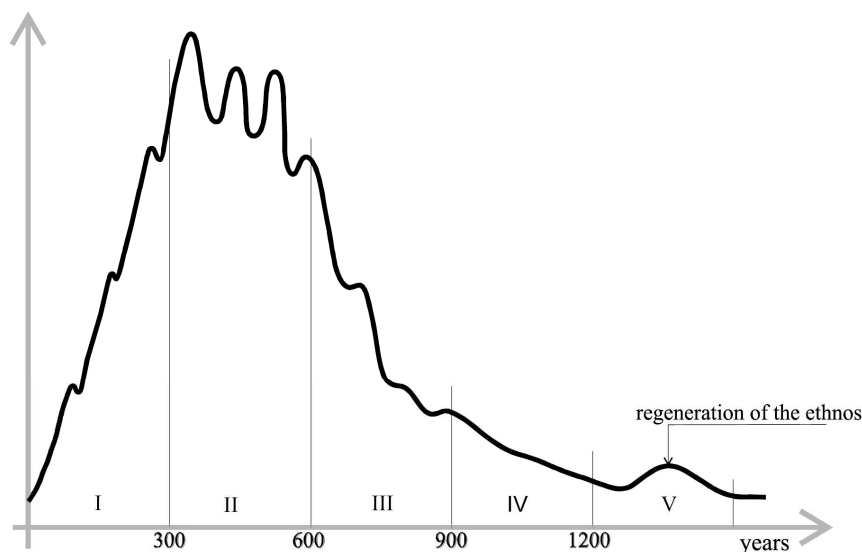

**Fig. 1.** The ethnogenesis by L. Humelov: I – V – phase of ethnogenesis

ETHNO-, ECO-, DEMO- AND URBO-  
GENESIS IN THE CONTEXT OF  
PHYSICAL THEORIES

According to the ethno genesis concept of L. Humyelov, the life cycle of ethnic (Fig. 1), consists of the next sequence of stages: growth (Phase *I*), strained stabilization (*II*), decay (*III*, *IV*) and revival (*V*). This cycle usually lasts for 1000-1200 years. However, in our accelerated time the USSR passed the stage for 74 years. At the end of the cycle ethnicity either disappear because of depopulation or divide into several ethnic groups, or enter the phase of homeostasis (*V*), which can reach and ethnic regeneration [6].

The environmental theory. The regularity of self-regulating ecosystems was experimentally established, according to which the population of any species can quickly increase their quantity in favorable environmental conditions (Fig. 2) *I* stage [7].

Due to the inertia the quantity exceeds the environment capacity (*I*, *a*), which causes the ecological crisis and environmental degradation. During the crisis (*II*) the environmental conditions become unfavorable for the quantity growth which causes its decline to a level lower than the capacity (*III*). There

comes a depopulation during which the environment gradually restores. His conditions become favorable (*IV*) again, and as a result the quantity rises (*V*). The population can enter into a phase of stabilization (*VI*) – a state of dynamic ecological equilibrium, subject to the slower growth in population. In the equilibrium state (in balanced and environmentally sustainable development) the existence of populations in the area subject to fluctuations in its quantity in the proper range of ecosystem sustainability by self-healing resources environment is possible in conventionally infinite time [4, 5].

This phenomenon, called "demographic transition", acknowledges our humanity. This event firstly manifests in the sharp increase of population, then in equally rapid decrease and stabilization of its quantity (Fig. 3).

Demographic transition is accompanied by economic growth, urbanization and aging of population. This transition has already culminated in developed countries and is completing in developing countries nowadays. As a result of the transition a new mode of human development should appear [8].

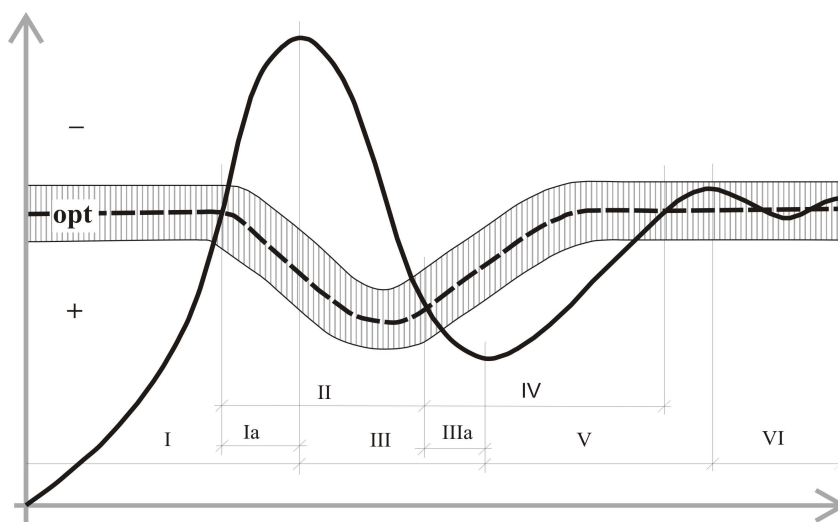

**Fig. 2.** The self-regulation ecosystem by V. Dolnyk:

- I-VI* – stages of ecosystem population capacity of the environment range of equilibrium,
- – population,
- - - – capacity of the environment,
- ||||| – range of equilibrium,
- ± opt – quality of environment

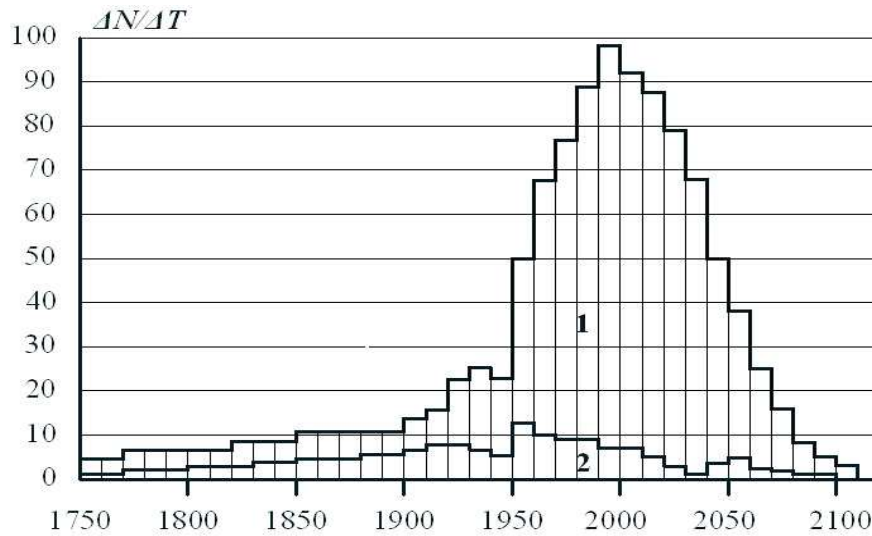

**Fig. 3.** Demographic transition, according to the UN:  
 1 – developing, 2 – developed countries

The concordant development stages were highlighted by Dzh. Forester in his investigation of dynamics of city development, as the social system, located in the "... endless external environment" [9, p.13, 14, 26]. According to his results, the urban areas (a system where people, business and housing interact) are a self-regulating system that tends to the equilibrium [9, p.118, 139]. Thus, when the city passes its 250 year cycle (from growth and through stagnation to the balance) its structural and functional elements will undergo qualitative and quantitative changes (Fig. 4) [9, p.15, 16].

The comparative analysis of general trends in ethnic-, eco-, demo- and urban systems showed that all models have the stages of rapid growth, resource crises, decline and stabilization, accompanied by consistent changes in terms of development and population. That means that the development based on single thermodynamic model, which results in successive changes of phases and phase transitions. The concept of such notions as "ethnic homeostasis", "stable population" and "balance in urban areas" expose the essence of a single phenomenon – the ecological balance in the interaction between population and environment. The development of considered

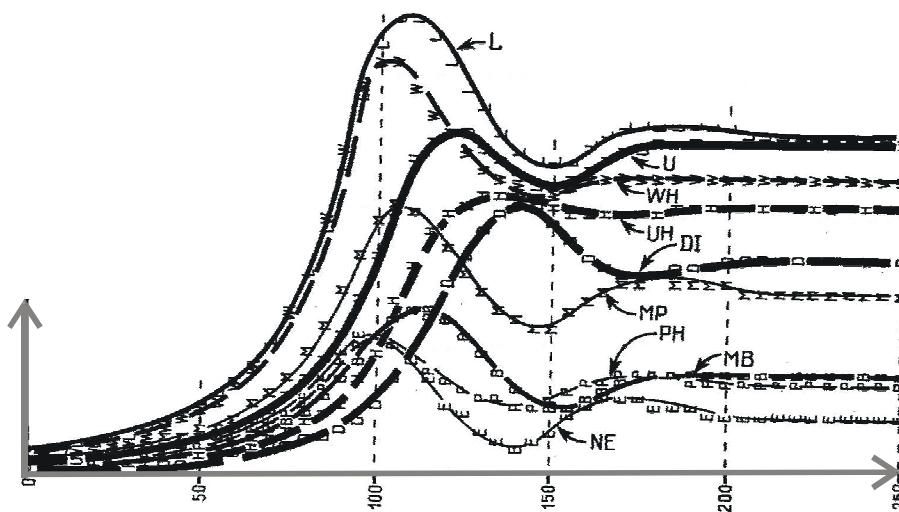

**Fig. 4.** The city development by Zh. Forester

systems is an oscillatory process, where the criterion of “best” is missed but the rhythm of states’ change exist as well as more or less intensity, speed and capacity development

Concerning the quantification of the definite potential, which exists due to the nature of interaction between population and environment, it should be noted that the total extent of interaction is the energy (*enérgeia – action, activity*, from the Greek). As known, there are two "great formula" definitions of energy in physics. The first one is Einstein's formula, according to which the energy increases together with increasing body mass:  $E = mC^2$ . The second one is Planck's formula, according to which the energy increases together with increasing frequency radiation:  $E = hv$  [10]. And reference to physics here is not random [11-14]. If carefully consider graphs on Fig. 1...4 one can notice that the dynamics of the initial stages of development of comparable systems is similar to the law of energy growth  $E = mC^2$ . The dynamics of the last stages can be compared with the law of energy growth  $E = hv$ . This inference coincides with the phenomenological theory of S. Kapitsa [8].

The analogy of the relativism in physics. According to S. Kapitsa research, the world's population grows in explosive, hyperbolic manner (Fig. 5) [8].

In both cases the growth laws are non-linear with escalation mode. The theory of relativity covers the escalation of speed, and the phenomenological theory covers the escalation of time (2012 – 2025 years). The growth of world population always follows the quadratic law and at the late time period of explosive growth the critical period of changing paradigms and development strategies arose. The transition to a new paradigm should lead to profound qualitative changes in outlook and a new strategy for human development [8]. The similar results were obtained in the Institute of Applied Systems Analysis of Academy of Sciences of Ukraine (Fig. 6) [15].

According to M. Zgurovsky, in the period from the 705 year BC to the present, the world development had six waves of system world conflicts, the duration of which decreases and intensity increases according to a hyperbolic law. The ratio of wave length fluctuates around the "golden ratio" and their flow subordinates to the law of element changes of Fibonacci series [15]. The seventh wave, or "the

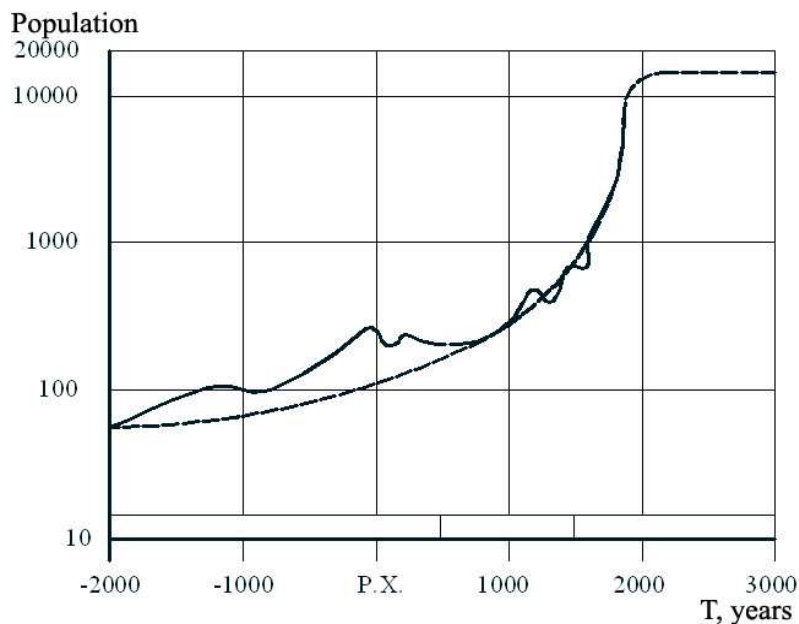

**Fig. 5.** Mathematical model of growth of world population by S. Kapitsa

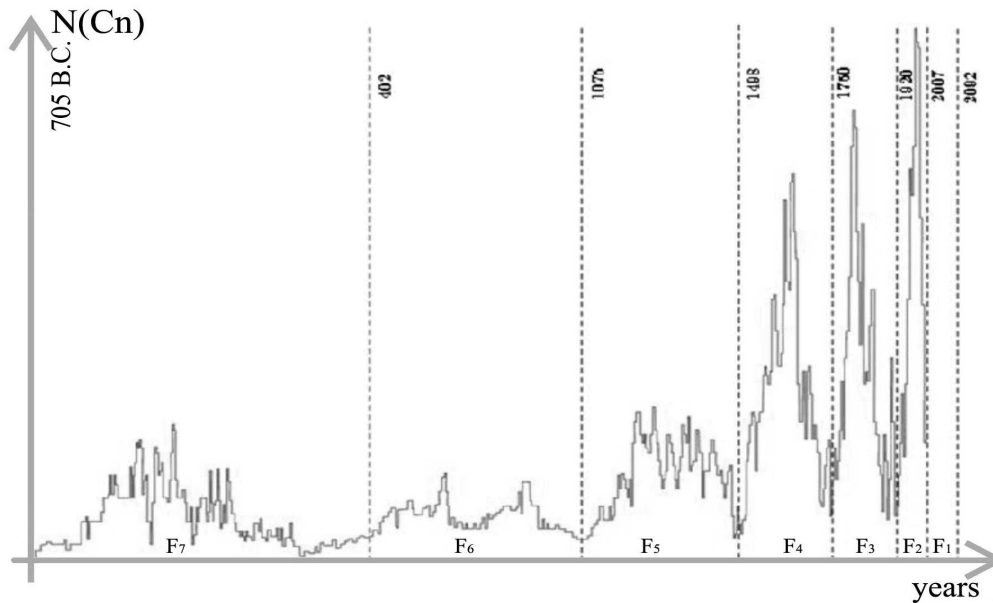

**Fig. 6.** Wave of global system conflicts by M. Zgurovsky

conflict of XXI century" may have (if the time will allow) the interval from 2010 to 2092 year [15]. However, when  $n > 6$  for  $C_n$  the conflicts waves, the Fibonacci sequence degenerates. Naturally the next question arises: what might happen to humanity? Maybe, it's a final cycle of a series of evolutionary and therefore "...the historical time is compressed in an exceptionally short interval..." [8].

Concerning the quantum analogy it must be mentioned that the time "compression" during the demographic transition leads to "docking" of relativistic and quantum mechanics. By S. Kapitza, the transition to quantum knowledge occurs when a continuous change of the system is determined by quantum conditions. In the case of "... increasing population it happens when the time of system change becomes a characteristic of the man ..." [8]. When growth rate for generation is compared with the population of the world, the growing self-similarity is violated, the demographic time-dependent system acquires a critical condition and there is a transition from the hyperbolic mode of development with particular reference to the other (may be macro quantum). The mathematical analysis of S. Kapitza shows that after the transition the stabilized development

of humanity becomes asymptotically stable [8].

#### PHYSICAL PARALLELS OF URBANIZATION AS ECOLOGICAL PHENOMENON

From the foregoing appears that quantitative growth is peculiar only for early stage of development of ecosystems on which they spend almost all available flow of energy [4]. These define the coincidence of economic growth goals and interests of "young" ecosystems. The stabilization of quantified growth and adaptation to development in the context of limited resources is favorable for "mature" system. At this stage, which, as already mentioned, can last indefinitely time, the quantitative growth strategy can be changed by the strategy of maximum preservation of ecosystem integrity. Now almost all available flow energy is expended for the ecosystem support [4]. At this point the economical becomes environmental [5]. Therefore the existence of two definitions of sustainability is not random. An economic understanding of sustainability reflects the tendency of quantitative increase of ecosystems in their reserve capacity. An ecological conception – is the tendency for transformation in depletion capacity. Behind the ambiguity of ide-

ologies of sustainability and changes of thinking paradigms, the reversibility of stages in the oscillatory cycles of ecosystems is hidden.

The management strategies. It should be noted that solving environmental problems today is complicated by the fact that “ecology” is usually understood as “environmental protection” and the avalanche of information concerning environmental pollution and degradation hide the knowledge about how nature arranged and processes that make it suitable for life. Consideration of general trends of ecosystem development at different levels of their structural and functional integrity: from individual cities and ethnic groups to humanity as a whole, showed some parallels with the processes that belong to “different physics” [11-14].

Within the subject-based knowledge, Physics is the science of nature; biology – is the science of wildlife ecology, in the literal sense – the science of organisms that studies the properties and establishes principles of joint interaction between living and inanimate nature [4, 5]. That means that ecology is a “great union theory” of biotic and abiotic interactions [12-14]. Physical theory, which seeks an unified basis to describe all four fundamental physical interactions (strong, weak, electromagnetic and gravitational) was called as a theory of super symmetry, or “super gravity theory” [16].

According to V. Vernadsky, the global ecosystem of Earth is in a state of dynamic equilibrium and is characterized by slow change of its system settings [17]. The same postulates and modern physics, according to which “... the stability of the main structural elements of the Universe – nuclei of atoms, stars and galaxies – are very critical regarding to the numerical values of constants”, relatively small changes of which “could lead to the formation of a qualitatively different world in which, in particular, the formation of life would not be possible...” [16].

As found, the pattern of self-regulation determines the development of urban areas [9, 11]. In this aspect, the territorial development becomes focused and projected, and, therefore, controlled processes with a given

goal –the sustainable development in a range of ecological balance [12-14].

The equilibrium is described by the ratio of symmetry – a ratio of 1:1 between population size and capacity of the environment (10% in the allowable range of deviation [5]). Same 1:1 ratio is a fundamental dimensionless constant of strong interactions in physics [16].

Concerning the weak interaction, which is responsible for radioactive decay of nuclei and moderate burning sun (the energy source and driving force of ecosystem) it must be mentioned that during the period of demographic transition the synchronization of human time leads to growth breach. The excessive nonstationary near the moment of escalation leads to stochastic “radioactive” decay complex structures threats [18].

The gravity. In the ecological theory the process of urbanization is similar with the strategy of creation of safe settlement, according to which, the gathering in a natural place covers its benefits in the form of increased viability of the group (defined by cooperation) and its disadvantages in the form of stress (caused by oversaturation, increased competition for resources protection, pollution and degradation) [4]. According to the principle of ecologically optimum density, the lack of population is unfavorable for the stability of populations, as well as his congestion [4, 5]. Therefore, urbanization is favorable for the population only in a certain range, frames of which depend on the demographic capacity of the environment (according to the Law of Ukraine “On Environmental Protection” – Article 51, 59, a demographic definition of capacity is required in planning urban and regional development).

This postulates the anthropological principle of modern physics, which requires the average density of matter in the Universe to be close to the critical  $\rho \approx \rho_{cr}$ . When  $\rho \ll \rho_{cr}$  the condensation of matter in stars and galaxies cannot exist, and when  $\rho \gg \rho_{cr}$  the lifetime of Metagalaxy could be so small that it has no time to develop life [16]. Thus, the anthropological principle and the principle of ecological optimum are essentially identical.

“Strangely enough, but the biological evolution and the evolution of the Universe have much in common. The formation of biological species and the creation of planets – are the creation of new information... The competition and natural selection are typical for alive and lifeless nature. The gravity discontinuities that signal the formation of stars and planetary systems compete with one another for condensed material” [16].

The surrounding areas compete with the cities for the population in convergent manner: “...when the city has more favorable conditions than the environment then it will concentrate people and commercial activities” [9]. The flow of people in the city “... will continue until overpopulation appears. Being unable to cope with overcrowding, the city will lose its appeal...” [9]. And here the other cities, regions, countries begin to “compete” for its people [14].

In the environmental aspects the increase of quantity reduction corresponds to the exhaustion – the restoration of the demographic capacity. In urban plane, this process can be identified in increasing – decreasing of population density. In an ecological sense the favorable conditions for economic recovery are caused by environment capacity reserve and “lack of territory populousness”; at the same time the unfavorable conditions are caused by the exhaustion of capacity, its overpopulation. Some favourable conditions have a certain “magnetism” that attracts people and leads to more quantity (natural, mechanical). Accordingly, the adverse conditions “push away” the population, which results in reducing of quantity [12, 14].

The electromagnetism. Exploring the properties and mathematically describing trends in urban areas as environmentally urban systems (EUS), some overlap in the frequency of changes of key parameters and other physical wave natured quantities are established [10, 12].

It may seem that the pendulum swings is not similar with a capacitor discharge through the coil inductance, and, especially, with ecodynamics of regional development. However, the urboecological processes, me-

chanical and electromagnetic waves are subject to the same quantitative laws. The determined fact comes to light when interested not in thing that vary (spring-load, the electric current in a circle or population of some region) but in sense of fluctuations. Similarity refers not to the nature of values, which change periodically, but to the processes of their changes [10, 18].

During the EUS stages development the ratio of capacity and population ( $C/P$ ) periodically changes as well as the population dynamics ( $\Delta P$ ) (see Fig. 2). The body (mounted on a spring) free of mechanical vibrations periodically changes its coordinates ( $x$ ) and projection speed ( $v_x$ ), while electromagnetic – capacitor charge ( $q$ ) and current intensity ( $i$ ) (Fig. 7) [10].

The inanimate physical systems are balanced. In equilibrium, they are displayed: in mechanics – through rejection; in electrical circuit – through the process of capacitor charging. The living systems are not balanced at first, but their goal is to achieve a balance through the development [4-7]. Returning the body on spring to its equilibrium caused by elastic force ( $F_x = -kx$ ), which is proportional to the body displacement from equilibrium position. The aspect ratio here is the spring stiffness ( $k$ ). The capacitor discharge (current occurrence) is caused by the voltage ( $u$ ) between capacitor plates, which is proportional to the charge ( $q$ ). Because ( $u = q/C$ ), then the aspect ratio here is the reciprocal capacity ( $1/C$ ) [10].

The development of some area leads to the exhaustion of its demographic capacity and population growth, which can be compared with the discharge capacitor and the advent of electric current in a circle. The population growth is caused by the reserve capacity (availability of resources opportunity in the environment to fit and feed a number of stable populations [6, 7, 11]). So the population growth is caused by the kind of voltage – the difference of potentials between the possible ecological (capacity) and implemented demographic (population) potential of the territory. The return to the EUS equilibrium can be caused by resistance of environment



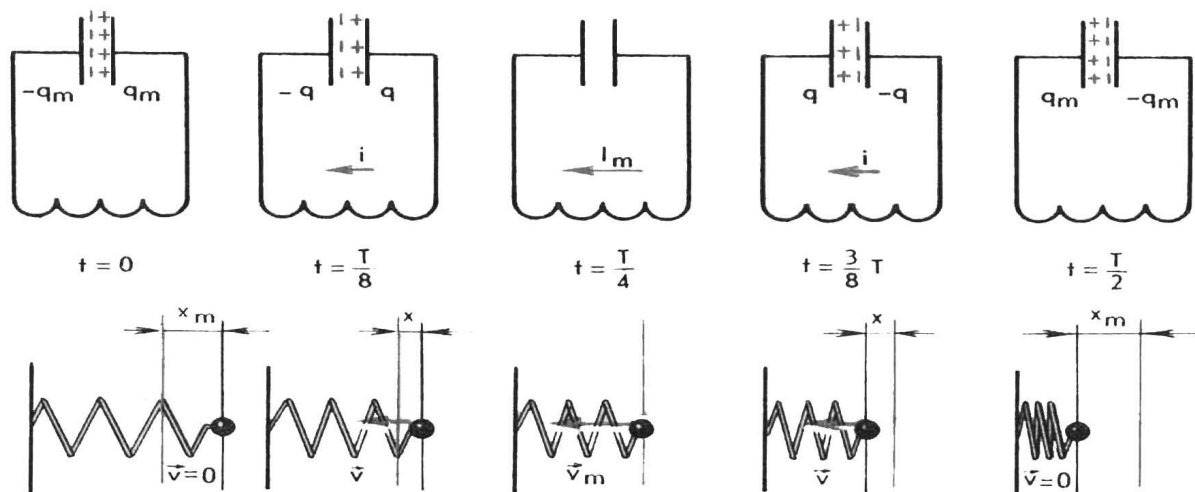

Fig. 7. The analogy between mechanical and electromagnetic fluctuations

( $1-P/C$  [4]). This resistance is generated by a kind of inductive growth and increases when the number of dimensions approach and exceed the dimensions of the container. The aspect ratio here presented as correlation ( $I/C$ ), which defines the “tightening of environment” [4]. The above mentioned appears as variability of small and relative constancy of large ecosystems [4, 5]. A gradual increase of urban territorial boundaries of the object (from city, urban area to the regions, their groups and of countries’ territories) is a kind of “regulatory mitigation” of Human Environment by town planning measures.

Due to inertia, the body only gradually increases the speed under the force and this speed is not immediately becomes equal to zero after the termination of the force. Similarly, and electric current in the coil, through the self-inductance, increasing gradually under tension and does not disappear immediately when the voltage becomes equal to zero (see Fig. 7) [10]. Similarly, the population in favorable environmental conditions that caused a stock tank, gradually increases and decreases (stabilized) immediately when the capacity is low (see Fig. 4). The time delay in

the growth-decline processes in favorable-unfavorable environmental conditions is caused by the inertia of EUS. The above mentioned procedures delay is inherent for all populations with complex life cycles and long-term individual development [4].

So circuit inductance ( $L$ ) performs the same function as the body mass ( $m$ ) in mechanics, in EUS its counterpart is the population ( $P$ ). Accordingly, the kinetic energy of the body ( $mv_x^2/2$ ) corresponds to magnetic field energy supply ( $Li^2/2$ ) and realized energy EUS ( $P_\Delta P^2/2$ ). The charging capacitor corresponds to the message body, which is sealed with spring by a potential energy ( $kx_m^2/2$ ) at its shift from equilibrium position at ( $x_m$ ) distance. In the capacitor this energy corresponds to the energy of the electric field ( $q_m^2/2C$ ) [10]. In the phenomenon of self-regulation the initial coordinate ( $x_m$ ) corresponds to the final – target parameters of environmentally safe, balanced and sustainable development of the EUS – the maximum number of its stable population ( $P_m$ ), which is determined by the demographic dimensions of capacity ( $C$ ). The considered compliance is listed in Tab. 1.

**Table 1.** The analogy between indicators of environmental and urban systems (EUS), mechanical and electrical quantities

Mechanical	Electrical quantities	Indicators of EUS
mass ( $m$ )	inductance ( $L$ )	population ( $P$ )
coordinate ( $x$ )	charge ( $q$ )	capacity = maximum number of stable population ( $C=P_m$ )
speed ( $v_x = x'$ )	current ( $i = q'$ )	population dynamics ( ${}_{\Delta}P$ or $P'$ )
acceleration ( $a_x = x''$ )	electromagnetic waves in the circuit ( $q'' = -q/LC$ )	growth-rate decline ( ${}_{\Delta}P'$ or $P''$ )
elastic force ( $F_x = -kx$ )	resistance circuit ( $R$ )	environment resistance ( $1 - P/C$ )
spring stiffness ( $k$ )	reciprocal capacity ( $1/C$ )	stiffness of environment ( $1/C$ )
potential energy ( $kx^2/2$ )	electric field energy ( $q^2/2C$ )	potential «electric» energy ( $C/2$ ) <sup>1</sup>
momentum ( $mv_x^2/2$ )	energy magnetic field ( $Li^2/2$ )	implemented «magnetic» energy ( $P_{\Delta}P^2/2$ ) <sup>2</sup>

**Notes.**

1. Agreed with data of Y. Odum: "Optimal maintenance capacity that can be stored for a long time, despite the whims of the environment, below the theoretical limit, perhaps by 50%" [4, part 1, p.180].
2. May explain some mentioned attractiveness of urban areas.

Therefore, the area is a kind of "natural solar power capacitor", which has a certain maximum charge ( $q_m$ ) or demographic capacity ( $C$ ). The moment when the capacitor discharge ( $q = 0$ ) and reaches maximum strength of current ( $i_m$ ), corresponds to passage of the body that is sealed with spring because of an equilibrium with maximum speed ( $v_m$ ). Then the capacitor starts to recharge ( $+q \rightarrow -q$ ), and the body – rotates in the opposite direction. After a half period ( $T/2$ ) the capacitor will fully recharge ( $+q_m \rightarrow -q_m$ ) and the power supply will be equal to zero ( $i = 0$ ).

This condition corresponds to the deviation of the limit in respect of the original, where his speed becomes equal to zero (see Fig. 7). The overcharging capacitor corresponds to changing parameters of stock – exhaustion of capacities and characteristics of area's quality ( $\pm$ ). When environmental

conditions become "rechargeable" and environmentally unfavorable, the population's dynamics first becomes equal to zero ( ${}_{\Delta}P = 0$ ), and then enter the negative values ( ${}_{\Delta}P < 0$ ) (see Fig. 2).

If there was no loss of energy, the oscillatory process in electrical circuit would have been a long term lasting and fluctuations would have been undamped. The defined notion is similar with the above mentioned definition ecological balance. In fact, the energy loss is inevitable. They are caused by the resistance circuit, in which the electromagnetic field of energy conversion in internal energy of conductor. In the absence of resistance, the total energy of the electromagnetic field can be kept [10]. And here is one more appropriate analogy. It is known that electromagnetic waves exist because the variable magnetic field generates an alternating electric field and vice versa [10].

As noted, each territory has a certain demographic capacity, which causes growth stock, and exhaustion – population decline (and it probably creates a kind of "wave of development" (see Fig. 1-6). For development purposes the territory's capacity usually exhausted – "the condenser is running out", and population size, number and attractiveness of cities increases (to a certain limit). A kind of conversion of potential energy of the region occurs in the realized power of its cities, which become "crystallized" over time in space. So the "electric field" of the region generates the "magnetic field" for the network of its populated cities. By analogy with a total energy of the electromagnetic field ( $W = Li^2/2 + q^2/2C = q_m^2/2C = Li_m^2/2$ , Table 1 [10, p.28]), total energy of the EUS can be defined as follows:

$$W_{EUC} = P_{\Delta}P^2/2 + C/2 = C = P_{\Delta}P_m^2/2.$$

The foregoing is consistent with the main postulate of relativity, according to which, in all inertial frames of reference all processes flow equally and in all such systems the physical laws have the same form [10]. The determined facts point to the possibility of scientific forecasting, planning and purposeful management of development in urban areas.

## CONCLUSIONS

The above mentioned similarities show that.

1. The self-regulation ecosystem, which is similar to "self-inductance of space-time development", characterized to the development of urban areas as environmental and urban systems;

2. The environmental problems of urbanization is a natural stage of a life cycle of oscillatory population of the ecosystem environment that strives for equilibrium – the main conditions of sustainable development, goals and the final phase of a cycle that can last indefinitely in time before a new cycle develop to another level of its hierarchical integrity;

3. The super complex ecosystems are stable. To maintain its integrity and periodically overcome the tendency to stochastic decay, they must exist in the vibrational mode, which allows the braking processes and establish the overall rate of development of components within these systems;

4. In the ecodynamics of the region, in any oscillatory process, the criterion of the "best" is absent. There is only rate changes states, more or less voltage, speed and capacity development, which is determined by its ecological age and environmental parameters of stock- depletion of demographic capacitance;

5. In the ecophysical context the urbanization phenomenon has some features of "super gravity", which also combine four fundamental physical interactions.

6. The Strategies for sustainable spatial-temporal development of urban areas (about 70% of Ukraine's population and over half of the world's population lives in cities) are proposed to build on the principles of conformity: the development phases (primary – growing, the ultimate – that transformed) and the territorial integrity of the ecosystem of the population-environment, which is regulated (region, country); economic programs and environmental development strategies that vary in time and measurements of the capacity due to the territory; the rate of fluctuation of population-environment ecosystem and its structural components – territorial, economic, social, demographic and urban systems.

Based on the abovementioned, the national and local strategies of environmentally safe, balanced and sustainable development is proposed to develop in view of potential of natural regions' growth of "young ecological age", which have a demographic stock capacity [19]. These regions were found during the study of possibilities, directions and parameters of sustainable development of Ukraine (Fig. 8).

The ecological age and potential of "mosaic asynchronous development" of its regions, as eco-urban city systems, are defined on the basis of comparison with the population demographic parameters of their capacity (calculated by the method of the author). These defined the possible regionalization of the territory and

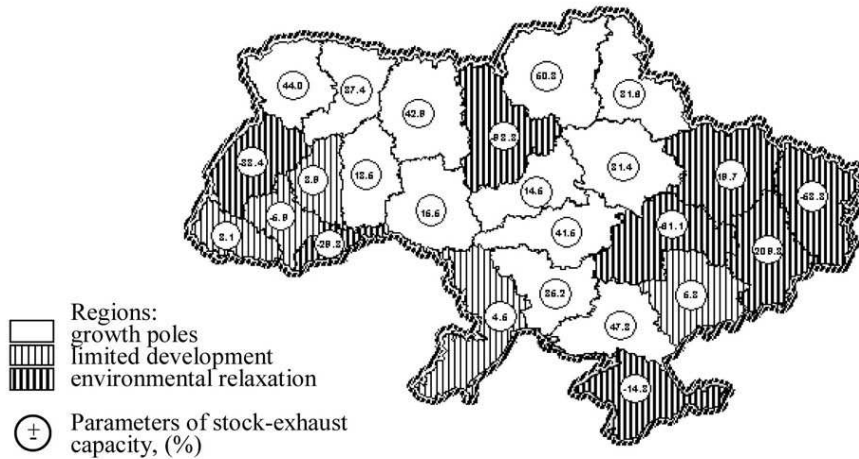

**Fig. 8.** Eco-city planning regionalization of the territory of Ukraine

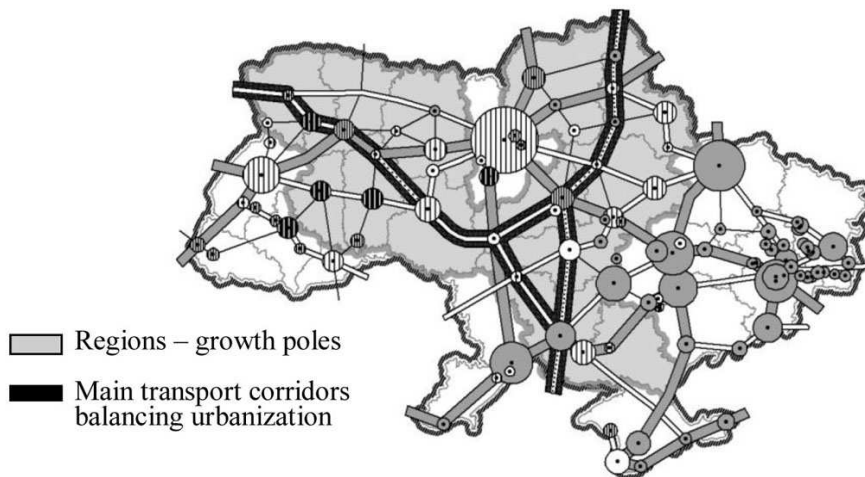

**Fig. 9.** A planning framework of the equilibrium zone of urbanization

helped to suggest a transformational model of resettlement planning, which ensures the spatial terms of environmentally sustainable, balanced and safe development of the country for which the question of stabilization of the population provides the guideline features in its national security [20-22] (Fig. 9).

REFERENCES

1. **Belivskij, G.O., Furdny R.S., Kostikov I.J., 2004.** Fundamentals of Ecology, a textbook. Kyiv, Lybid, 408. (in Ukraine).
2. **Kavtaradze, D., 1990.** Nature: from of protection - to slaughter. Knowledge is power, Vol.3, 9-13. (in Russian).
3. **Hesle, V., 1994.** Philosophy and ecology: translation from German, AO Kamy, Moscow, 192. (in Russian).
4. **Odum, J., 1986.** Ecology: in 2 parts. Moscow, Mir, 376+328. (in Russian).
5. **Reimers, N.F., 1994.** Environment (theory, laws, rules, and the principles). Moscow, the magazine "Young Russia ", 367. (in Russian).
6. **Humylev, L.N., 1990.** Geography ethnos in a historic period. Sankt-Petersburg, Nauka, 270. (in Russian).
7. **Dolnyk, V.R., 1992.** Whether there are biological mechanisms of regulation of the number of people. Nature, № 6, 3-16. (in Russian).
8. **Kapitsa, S.P.** Synergetics and demography <http://www.uni-dubna.ru/~mazny/students/site2/ideal6.htm>. (in Russian).

9. **Forrester, J., 1974.** Dynamics of development of the city. Moscow, Progress, 286. (in Russian).
10. **Myakyshev, G.Y., Buhovtsev B.B., 1993.** Physics: textbook for 11 classes. Moscow, Prosveschenie, 254. (in Russian).
11. **Ustinova, I., 2005.** Ecology-town-planning a substantiation of sustainable development of the urbanized territories of Ukraine. Abstract thesis Ph. D. in architecture, Candidate of Sciences in architecture: 18.00.04, Kyiv, KNUCA, 19. (in Ukraine).
12. **Ustinova, I., 2007.** The environmental parallels of the physical laws in the process of urban ecological systems. Modern problems of architecture and urban planning, Kyiv, KNUCA, Vol.18, 184-191. (in Ukraine).
13. **Ustinova, I., 2008.** The physical parallels of environmentally sound development. Modern problems of architecture and urban planning, Kyiv, KNUCA, Vol.20, 229-233. (in Ukraine).
14. **Ustinova, I., 2009.** The eco-physical similarity of urbanization. Modern problems of architecture and urban planning, Kyiv, KNUCA, Vol.22, 293-298. (in Ukraine).
15. **Zhurovsky, M.Z., Hvyshyany A.D., 2008.** The global modeling processes of sustainable development in the context of quality and safety of people life (2005-2007/2008 Years). Kyiv, Polytehnika, 331. (in Russian).
16. **Spiridonov, O.P., 1991.** The fundamentals physical constants. Kyiv, High School, 238. (in Russian).
17. **Vernadsky V.I., 1978.** Living substance, Moscow, Nauka, 358. (in Russian).
18. **Knyazev, E.N., Kurdyumov, S.P., 2005.** Founded synergy. Moscow, Nauka, 240. (in Russian).
19. **Ustinova, I., 2010.** Management of territorial spread in the context of sustainable development. Euro-eco 2010. International Kongress. Hannover, Europäische Akademie für Naturwissenschaften, 124-125.
20. **Vetrova N., 2013.** Ecological audit and ecological monitoring in environmental safety of a region. Motrol: kom. Mot. Energ. Roln., OL PAN, Vol.14-1, 80-85.
21. **Voloshkina O., Bereznitska J., 2014.** Development of Ukraine Territory Flooding Processes; Its Parameters and the Influence on the Environmental Safety Level. Motrol: kom. Mot. Energ. Roln., OL PAN, Vol.16-8.
22. **Kryvomaz T., Voloshkina O., 2014.** The Risk Assessment of Threats from Biological Objects in Environmental Safety. Motrol: kom. Mot. Energ. Roln., OL PAN, Vol.16-8, 137-144.

ПРИНЦИПЫ И СТРАТЕГИИ  
УСТОЙЧИВОГО РАЗВИТИЯ РЕГИОНОВ

**Аннотация.** Изложены результаты исследования основ и стратегий устойчивого развития человечества в экофизическом значении этого явления.

**Ключевые слова:** устойчивое развитие, экосистемная саморегуляция, экологическое равновесие, демографическая емкость, эколого-градостроительные системы.



## Analysis of the predictive properties of Brown's model in the extended domain of the internal parameter

Yuriy Romanenkou

N.Ye. Zhukovsky National Aerospace University “Kharkiv Aviation Institute  
Chkalova str., 17, Kharkiv, Ukraine, 61070, e-mail: KhAI.management@gmail.com

**Summary.** The paper analyses the predictive properties of Brown's adaptive model in the extended domain of internal parameters, which relates to the class of problems in parametric synthesis of forecast models, namely: evaluating the stability of model predictive properties to variation of internal parameters by searching for forecast robustness domains. The approach suggested is illustrated by an example.

**Key words:** Brown's model, exponential smoothing, parametric synthesis, forecast robustness.

### INTRODUCTION

Among the key functions of systems for controlling social and economic processes according to [1] are forecasting and process planning. Implementing this function without advanced forecasting methods is impossible, and any attempts to manage without them in current conditions are foredoomed, at least, to a financial failure. Underestimating the importance of forecasting and the quality of forecasts downplays the competitive advantages of enterprises and organizations. This makes forecasting one of the key tasks in controlling social and economic processes. Proper usage of predictive models, a clear understanding of their internal workings, and a knowledge of the limits of model adequacy are the necessary conditions for quality and well-grounded managerial decisions, and consequently, for effective management as a whole.

This paper analyses the predictive properties of Brown's adaptive model in the ex-

tended domain of internal parameters, which relates to the class of problems in parametric synthesis of forecast models.

### REVIEW OF PUBLICATIONS

R. Brown suggested his predictive model [2] or exponential smoothing model in the late '50s of the last century and found application in tens of engineering's tasks [3-8]. His concept was to use the exponential average value of a stationary time series:

$$F_t = \alpha A_{t-1} + \alpha(1-\alpha)A_{t-2} + \alpha(1-\alpha)^{n-1}A_{t-n} = \sum_{i=1}^n \alpha(1-\alpha)^{i-1}A_{t-i}, \quad (1)$$

for short-term forecasts, where  $F_t$  is forecast at point of time  $t$  (exponential mean),  $A_{t-1}, A_{t-2}, \dots, A_{t-n}$  are series values at respective time points,  $n$  is time series length,  $\alpha$  is smoothing factor (a constant).

Practical application of Brown's model requires solving the model parametric setting problem, i.e. substantiate the choice of smoothing factor  $\alpha$ . Many publications have dealt with the problem of choosing this Brown's model factor, e.g. [9-15]; however, to date there is no single approach to this.

The classical range of admissible values of the smoothing factor is the interval  $\alpha \in [0, 1]$ . This range is logically conditioned by the necessity to ensure conver-

gence of the series of weight coefficients in formula (1)

$$\{a_k\}_{k=1}^n = \alpha, \alpha(1-\alpha), \dots, \alpha(1-\alpha)^{n-1} \quad (2)$$

to unit.

At the turn of the Millennium, S.G. Svetun'kov in his studies, e.g. [10], demonstrated that the classical range  $\alpha \in [0, 1]$  could be extended to  $\alpha \in [0, 2]$  without violating the condition of convergence of weight coefficients series (2) to unit. In this case, series (2) changes from a fixed-sign one in the interval  $\alpha \in [0, 1]$  to a variable-sign one in the interval  $\alpha \in (1, 2]$ .

Set  $\alpha \in (1, 2]$  of the internal factor of Brown's predictive model is known as the 'out-of-limit' one [16-18] or Svetun'kov's set [19].

Let set  $K_c$  be a classical admissible set, set  $K_{out}$  be an out-of-limit admissible set, and set  $K_{ext} = K_c \cup K_{out}$  be an extended admissible set of smoothing factor  $\alpha$ :

$$\begin{cases} K_c = \{\alpha : 0 \leq \alpha \leq 1\}, \\ K_{out} = \{\alpha : 1 < \alpha \leq 2\}, \\ K_{ext} = \{\alpha : 0 \leq \alpha \leq 2\}. \end{cases} \quad (3)$$

### PROBLEM STATEMENT

The objective of this study is investigating the predictive properties of Brown's model on an extended set  $K_{ext}$  of internal factor  $\alpha$ , and ensuring stability of model predictive properties to variations of internal factors by searching for forecast robustness domains.

### MAIN PART

Let us investigate the behaviour of the sum of series (2) with an increasing number of its terms  $n$  on extended set  $K_{ext}$  of smoothing factor  $\alpha$ :

$$S_n = 1 - (1-\alpha)^n. \quad (4)$$

Fig. 1 shows dependence  $S_n(\alpha, n)$  according to (4).

From Fig. 1, it is obvious that the sum of coefficients in (1) is not equal to unit in all cases. This means that Brown's model uses strictly speaking not the exponential average as a forecast, but the exponential weighted value of the initial series.

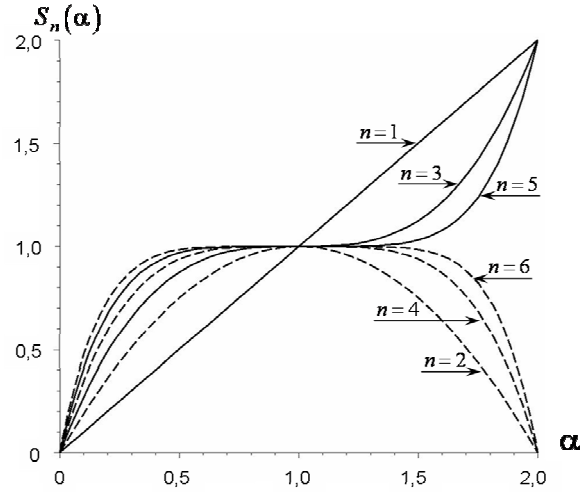

**Fig. 1.** Sum of series of Brown's model weight coefficients vs. smoothing factor  $\alpha$  and number of series elements  $n$  on extended set  $K_{ext}$

The closeness of the forecast to the exponential average can be evaluated analytically. For this, let us transform dependence (4) by mirror imaging a group of growing branches with respect to a unit level.

Fig. 2 shows dependence

$$S'_n = 1 - |1-\alpha|^n. \quad (5)$$

Fig. 2, besides showing dependence  $S'_n(\alpha, n)$ , shows a plane at level  $1 - 0,01\lambda = 0.95$ , where  $\lambda$  is measure of closeness to the exponential average value. It intercepts the domain of parameters in plane  $(\alpha, n)$ , within which the predictive value is close to the exponential average one by less than  $\lambda$  percent.

The boundaries of this domain can be found from relationship

$$1 - |1-\alpha|^n \geq 1 - 0,01\lambda. \quad (6)$$



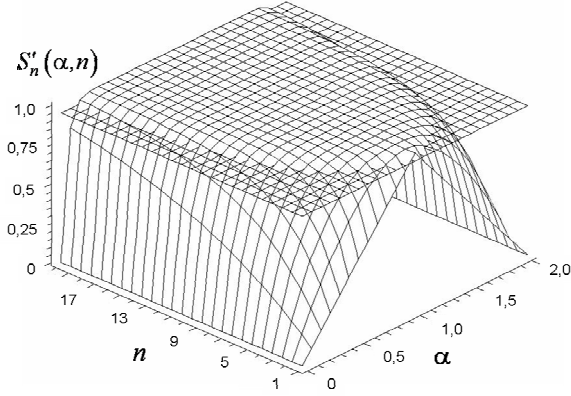

**Fig. 2.** Transformed sum of Brown's model weight coefficients vs. smoothing factor  $\alpha$  and number of series elements  $n$  on extended set  $K_{ext}$

Hence,

$$|1 - \alpha|^n \leq 0,01\lambda, \quad (7)$$

or finally,

$$1 - (0,01\lambda)^{1/n} \leq \alpha \leq 1 + (0,01\lambda)^{1/n}. \quad (8)$$

The domain satisfying (8) is shown in Fig.3.

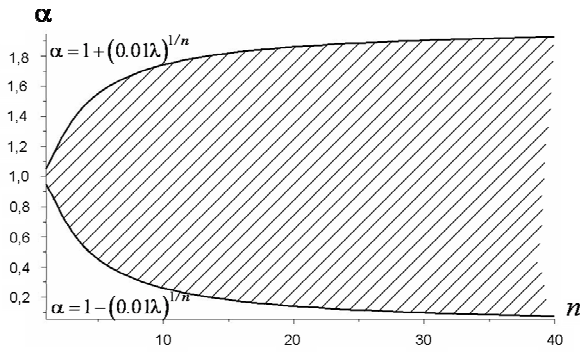

**Fig. 3.** Domain in plane of factors  $(\alpha, n)$  ensuring closeness of Brown's model forecast to the average exponential value of  $n$  series elements by less than  $\lambda$  percent ( $\lambda = 5$ )

The parametric synthesis problem can be solved analytically only 'retrospectively', i.e. for time points  $(t-1)$ ,  $(t-2)$  and earlier ones [14]. This requires solving retrospective equations of the kind:

$$F_{t-1}(\alpha) = \sum_{i=1}^{n-1} \alpha(1-\alpha)^{i-1} A_{t-i-1} = A_{t-1}. \quad (9)$$

Let us consider a situation when an equation of the (9) kind has been formed for one time point  $(t-1)$  and has more than one real root on extended admissible set  $K_{ext} = \{\alpha : 0 \leq \alpha \leq 2\}$ . This means that there are real  $\alpha_1, \alpha_2, \dots, \alpha_j, j \geq 2$ , which being the roots of retrospective equation (9), would ensure an accurate forecast at point of time  $(t-1)$ .

Hence, one faces the problem of a well-grounded choice among  $\alpha_1, \alpha_2, \dots, \alpha_j$  of smoothing factor  $\alpha$  values for forecasting at time point  $t$ .

Obviously, as to their retrospective accuracy, all values  $\alpha_1, \alpha_2, \dots, \alpha_j$  are equivalent by virtue of the concept of retrospective analysis, i.e. ensuring absolute accuracy for past time points with respect to  $t$ .

In this situation, the criteria for choosing smoothing factor  $\alpha$  can be sensitivity and robustness of forecasts obtained for  $\alpha_1, \alpha_2, \dots, \alpha_j$ . The following method is suggested for choosing smoothing factor  $\alpha$  for the above-stated conditions (Fig. 4).

Stage 1. *Forming retrospective equation* of the kind (9) for time point  $(t-1)$  and a sampling length of  $n$  elements.

Stage 2. *Searching for the real roots of retrospective equation* of the kind (9) by using applied mathematical software packages (for instance, Maple) or the graphical method.

If no real roots exist on the extended admissible set  $K_{ext} = \{\alpha : 0 \leq \alpha \leq 2\}$ , then Brown's model (1) is inapplicable for predicting the series being investigated and requires a structural complication.

If on set  $K_{ext}$  there exists one real root, it shall be accepted as the value of smoothing factor  $\alpha$  for forecasting at time point  $t$ . Sensitivity and robustness of the forecast can be evaluated according to the following stages, though in this case they cannot be the criteria for parametric setting of the model.

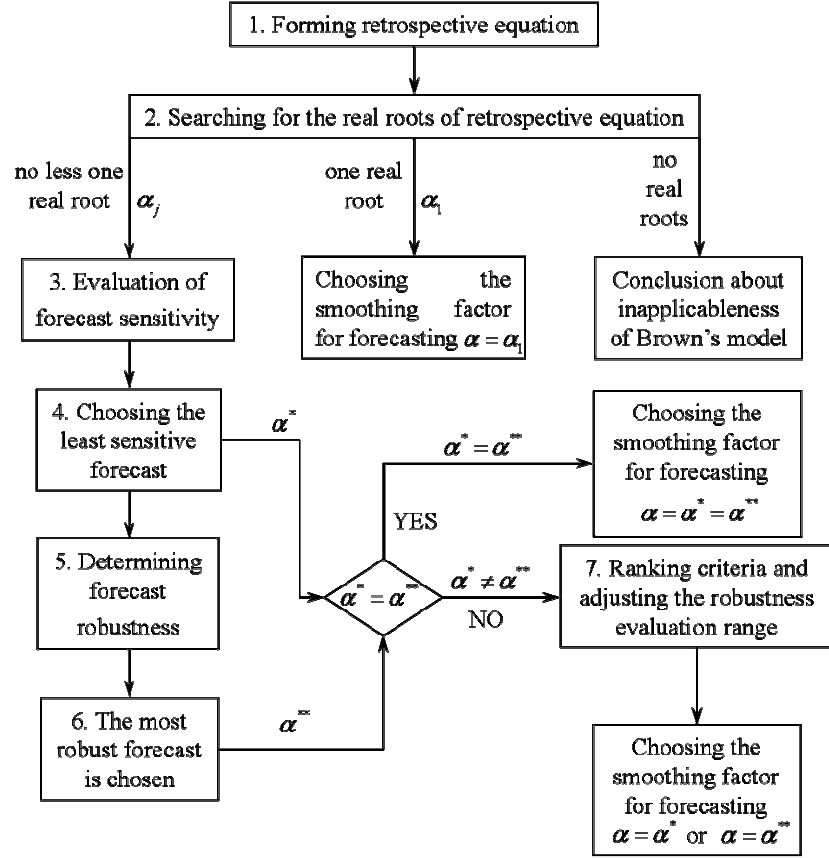

**Fig. 4.** Method for choosing smoothing factor  $\alpha$  by the criteria of sensitivity and robustness of retrospective forecasts

Stage 3. *Evaluation of forecast sensitivity* is suggested to be done by calculating the sensitivity equal to the module of the derivative of forecast function  $F'_{t-1}(\alpha)$  in points  $\alpha = \alpha_1, \alpha = \alpha_2, \dots, \alpha = \alpha_j, \quad j \geq 2,$  where  $\alpha_1, \alpha_2, \dots, \alpha_j$  are real roots of retrospective equation (9).

Stage 4. *Choosing the least sensitive forecast.* This is done by solving the optimization problem:

$$\alpha = \alpha^* : \left| F'_{t-1}(\alpha^*) \right| = \min_i \left| F'_{t-1}(\alpha_i) \right|, \quad i = \overline{1, j}. \quad (10)$$

Value  $\alpha = \alpha^*$  ensures minimal forecast sensitivity to small variations of smoothing factor  $\alpha$  in the vicinity of  $\alpha^*$ .

Stage 5. *Determining forecast robustness.* Forecast robustness can be evaluated graphically by showing the sensitivity of the forecast relative error to smoothing factor  $\alpha$  variations.

For this, we shall substitute

$$\alpha = \alpha_i + \Delta\alpha_i, \quad i = \overline{1, j}, \quad (11)$$

where  $\alpha_i$  are real roots of equation (9), into the expression for the forecast relative error  $\varepsilon_F$

$$\varepsilon_F = \frac{F_{t-1}(\alpha) - A_{t-1}}{A_{t-1}} \cdot 100. \quad (12)$$

Systematic error  $\Delta\alpha_i$  with respect to real root  $\alpha_i$  can be expressed through the relative error of choosing smoothing factor  $\alpha$ :

$$\Delta\alpha_i = 0,01\alpha_i\varepsilon_\alpha, \quad (13)$$

where  $\varepsilon_\alpha$  is relative error of choosing smoothing factor  $\alpha$  in percent.

With account of the symmetry of the function of the sum of weight coefficients (4) in

Brown's model on classical  $K_c$  and out-of-limit admissible set  $K_{out}$ , expression (13) shall be used with  $\alpha_i \in [0, 1]$ , and with  $\alpha_i \in [0, 1]$   $\Delta\alpha_i$  shall take the form:

$$\Delta\alpha_i = 0,01(2 - \alpha_i)\varepsilon_\alpha. \quad (14)$$

Making all the substitutions (12) yields

$$\varepsilon_F = \frac{100}{A_{t-1}} \times \sum_{i=1}^{n-1} \alpha_i (1 + 0,01\varepsilon_\alpha) (1 - \alpha_i - 0,01\alpha_i\varepsilon_\alpha)^{i-1} A_{t-i-1} - (15)$$

and

$$\begin{aligned} & -100, \alpha_i \in [0, 1] \\ & \varepsilon_F = \frac{100}{A_{t-1}} \times \sum_{i=1}^{n-1} (\alpha_i + 0,01(2 - \alpha_i)\varepsilon_\alpha) \times \\ & \times (1 - 0,01(2 - \alpha_i)\varepsilon_\alpha)^{i-1} A_{t-i-1} - 100, \\ & \alpha_i \in (1, 2]. \end{aligned} \quad (16)$$

If dependencies (15) and (16) for all real roots of retrospective equation (9) with a total number of  $j$  shall be shown in a single plane of parameters  $(\varepsilon_F, \varepsilon_\alpha)$ , then one can easily evaluate the degree of robustness of forecasts obtained for different  $\alpha$  (Fig. 5).

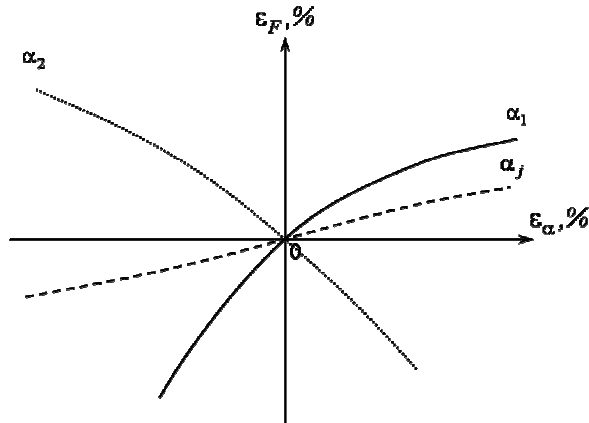

**Fig. 5.** Sensitivity of forecast relative error  $\varepsilon_F$  to variation of smoothing factor  $\alpha$  by  $\varepsilon_\alpha$  percent with respect to retrospective equation roots

All the curves in Fig. 5 corresponding to real roots of retrospective equation (9) pass through the origin of coordinates because the forecast relative error at  $\alpha = \alpha_i, i = \overline{1, j}$  equals zero.

The closer the curve approaches the X-axis the less sensitive is the forecast to variation of  $\alpha$ , and hence, it possesses better robustness.

Analytically, it is suggested to be evaluated by an inverse of the module of the definite integral of function  $\varepsilon_F(\varepsilon_\alpha)$  over a concrete interval. Let it be called the robustness parameter:

$$r_i^{(\beta)} = \frac{1}{\int_{-\beta}^{\beta} |\varepsilon_{F_i}(\varepsilon_\alpha)| d\varepsilon_\alpha}, \quad (17)$$

where  $r_i^{(\beta)}$  is robustness parameter for the  $i$ -th forecast in the range  $(-\beta; \beta)$ ,  $\varepsilon_{F_i}(\varepsilon_\alpha)$  is the analytical dependence of the error of the  $i$ -th forecast on the error of choosing the smoothing factor.

Obviously,  $r_i^{(\beta)} \in (0, \infty)$ . Small values of the robustness parameter mean significant sensitivity or forecast instability to smoothing factor  $\alpha$  variations. Big values of the robustness parameter mean that, over the whole interval  $(-\beta; \beta)$ , the sensitivity curve in Fig. 5 is in close proximity to the X-axis, ensuring thereby insensitivity or stability of forecast quality to smoothing factor  $\alpha$  variations.

Stage 6. *The most robust forecast is chosen by solving optimization problem:*

$$\alpha = \alpha^{**} : r_i^{(\beta)}(\alpha^{**}) = \max_i r_i^{(\beta)}, i = \overline{1, j}. \quad (18)$$

In case of matching optimal values of  $\alpha^*$  and  $\alpha^{**}$  found by sensitivity and robustness criteria, respectively, choosing the smoothing factor for forecasting for the next time period  $\alpha = \alpha^* = \alpha^{**}$  seems well-grounded.

Stage 7. *Ranking criteria and adjusting the robustness evaluation range.* Fig. 6 shows the case when  $\alpha^* \neq \alpha^{**}$ , and poses the

problem of ranking sensitivity and robustness criteria.

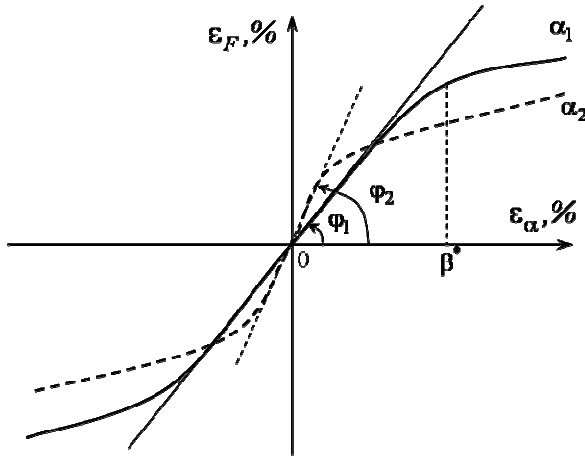
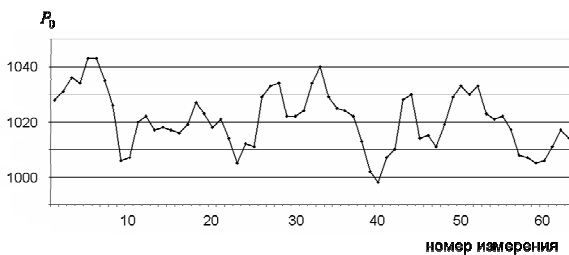

**Fig. 6.** Arrangement of sensitivity curves of forecast errors for  $\alpha^* \neq \alpha^{**}$

Sensitivity is a moment or differential estimate characterizing the sensitivity curve slope in point  $\alpha = \alpha_i$  or  $\varepsilon_\alpha = 0$  (in Fig. 6,  $\varphi_1 < \varphi_2$ ). Robustness is an integral estimate characterizing the area under the sensitivity curve (in Fig. 6,  $r_1^{(\beta)} > r_2^{(\beta)}$  for  $\beta < \beta^*$  and  $r_1^{(\beta)} < r_2^{(\beta)}$  for  $\beta > \beta^*$ ).

Hence, the researcher is forced to determine one's subjective preference in regard to criteria or determine such a range  $(-\beta; \beta)$ , for which the solutions of the optimization problem for two criteria match.

**Example.** As an example, let us consider a series of climate data from the weather conditions archive (<http://meteo.infospace.ru>) namely: sea level atmospheric pressure  $P_0$  recorded from 26.11.1998 to 2.02.1999 by the Kharkiv Weather Station daily at 12:00 local time (Fig. 7).



**Fig. 7.** Climate data series

Let us apply the suggested method of choosing  $\alpha$  for sampling from the 47<sup>th</sup> to the 57<sup>th</sup> series elements.

Stage 1. The following retrospective equation is formed:

$$F_{12} = 1011\alpha^{11} - 11129\alpha^{10} + 55695\alpha^9 - 167269\alpha^8 + 334979\alpha^7 - 469696\alpha^6 + 470527\alpha^5 - 336738\alpha^4 + 168687\alpha^3 - 56305\alpha^2 + 11246\alpha = 1007. \quad (19)$$

Stage 2. The real roots of the equation are located on the extended admissible set of smoothing factor  $\alpha$ :

$$\alpha_1 = 0,3439; \alpha_2 = 1,1192; \alpha_3 = 1,5900. \quad (20)$$

Stage 3. Let us calculate the derivative

$$F'_{12} = \frac{dF_{12}}{d\alpha} = 11121\alpha^{10} - 111290\alpha^9 + 501255\alpha^8 - 1338152\alpha^7 + 2344853\alpha^6 - 2818176\alpha^5 + 2352635\alpha^4 - 1346952\alpha^3 + 506061\alpha^2 - 112610\alpha + 11246 \quad (21)$$

in points (20):

$$\begin{cases} F'_{12}(\alpha_1) = 145,6646, \\ F'_{12}(\alpha_2) = -7,7603, \\ F'_{12}(\alpha_3) = 48,0280. \end{cases} \quad (22)$$

Stage 4. The smaller by module derivative indicates the least sensitive forecast obtained with smoothing factor  $\alpha^* = \alpha_2 = 1,1192$  (Fig. 8).

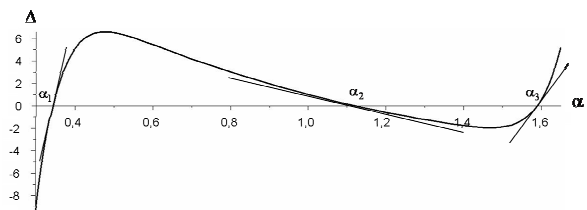

**Fig. 8.** Real roots of retrospective equation (19)

Stage 5. Graphical evaluation of forecast robustness is shown in Fig. 9.

Fig. 9 shows that the forecast obtained for  $\alpha = \alpha_2$  is the least sensitive to variation of smoothing factor  $\alpha$ , and hence, is more robust. Note that the forecast obtained for  $\alpha = \alpha_1$  has the worst robustness of the three ones, though when the classical admissible set  $K_c = \{\alpha : 0 \leq \alpha \leq 1\}$  is used it is the only admissible one.

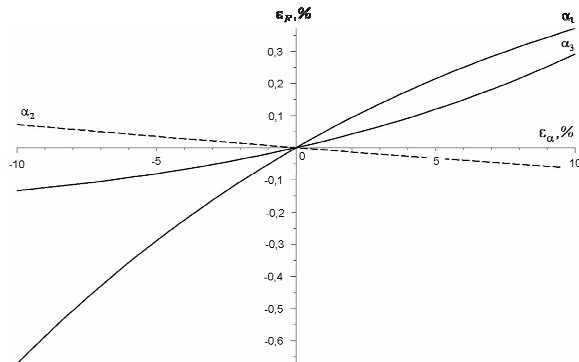

**Fig. 9.** Graphical evaluation of forecast robustness

Let us determine the robustness parameters for three forecasts for  $\beta = 10\%$ :

$$\begin{cases} r_1^{(10)} = \frac{1}{\int_{-10}^{10} |\varepsilon_{F1}(\varepsilon_\alpha)| d\varepsilon_\alpha} = 0,1964, \\ r_2^{(10)} = 1,4731, r_3^{(10)} = 0,4907. \end{cases} ; (23)$$

Stage 6. The most robust forecast corresponds to  $\alpha^* = \alpha_2 = 1,1192$ .

Stage 7. In this case, criteria ranking and adjustment of the robustness evaluation range is not required because  $\alpha^* = \alpha^{**} = 1,1192$ . This value of  $\alpha$  will be used for forecasting for the next time point. The forecast shall be calculated for two samples with a length of 11 and 12 series elements, having compared them for relative accuracy ( $\varepsilon_i^{(11)}$  and  $\varepsilon_i^{(12)}$ ). The simulation results are shown in Table 1.

As Table 1 shows, choosing smoothing factor  $\alpha = \alpha^* = \alpha^{**} = 1,1192$  ensures not only the robustness of the retrospective forecast to variation of  $\alpha$ , but also the robustness of the

current forecast to variations in sample length  $n$ .

**Table 1.** Retrospective analysis of climate data and evaluating the sensitivity and robustness of forecasts

Series elements	47-57	47-57	47-57
$i$	1	2	3
$\alpha_i$	0,3439	1,1192	1,5900
$F'(\alpha_i)$	145,6646	<b>-7,7603</b>	48,0280
$r_i^{(10)}$	0,1964	<b>1,4731</b>	0,4907
$\varepsilon_i^{(11)}$	-0,1369	<b>0,1990</b>	0,6816
$\varepsilon_i^{(12)}$	0,1986	<b>0,1990</b>	0,1990

## CONCLUSIONS

Using an extended admissible set of smoothing factor  $\alpha$  in Brown's model requires additional analysis of the properties of the series and the model per se because the algebraic properties of series (2) of the model weight coefficients are different on the classical admissible set  $K_c$  and the out-of-limit admissible set  $K_{out}$ . Reducing the process of parameter setting of Brown's model to simple "smoothing factor choosing" often unduly simplifies forecasting and results in loss of model adequacy, and hence, forecast accuracy. A method has been suggested for choosing smoothing factor  $\alpha$  by the criteria of sensitivity and robustness of retrospective forecasts. It allows determining the setting parameters of Brown's model ensuring maximum stability of forecasts to variations of model internal parameters. The method suggested is illustrated by an example using a set of real climate data.

## REFERENCES

1. **Savello L.L., Andreev G.N., 2011.** About category "management" in social and economic systems (in Russian). Modern problems of science and education, URL: [www.science-education.ru/100-5244](http://www.science-education.ru/100-5244).

2. **Brown R.G., 1963.** Smoothing forecasting and prediction of discrete time series, New York City.
3. **Sinyaeva O., Zavgrodnny A., Obyhlost A., 2013.** The question of planning experiment on the basis of application package Excel, MOTROL. Commission of Motorization and Energetics in Agriculture, Vol.15, Nr 7. 199-204. (in Russian).
4. **Kholopcev A., Aksenova A., 2013.** Projections of wind speed characteristics in Europe with the accounting apportionment superficial temperatures in north Atlantic an example of Black sea. MOTROL. Commission of Motorization and Energetics in Agriculture, Vol.15. Nr 5, 139-143. (in Russian).
5. **Kuz'minskij R., 2013.** Improving the model for predicting programs of machine repair, their parts and units using asymmetric distributions. MOTROL. Commission of Motorization and Energetics in Agriculture. Vol.15, Nr 4, 167-171. (in Russian).
6. **Atamanyuk I., Kondratenko Yu., 2013.** Information technology of determination of descriptions of optimum polynomial prognosis algorithm of the state of technical systems. MOTROL. Commission of Motorization and Energetics in Agriculture., Vol.15, Nr 2, 47-50. (in Russian).
7. **Shchelkalin V.N., 2014.** Hybrid methods of predicting non-stationary time series, Eastern-European journal of enterprise technologies, Nr 5(4), 43-62. (in Russian).
8. **Demidova L.A., Pyl'kin A.N., Skvortsov S.V., 2012.** Hybrid models of prognostication of short temporal rows. Moscow, Hot line Telekom, 208. (in Russian).
9. **Bestuzhev-Lada I.V., 1982.** Forecasting Workbook. Moscow, Mysl, 430. (in Russian).
10. **Svetun'kov S.G., 2002.** About extension of limits for Brown method application, News-bulletin of Saint-Petersburg University of Economics and Finances, Saint-Petersburg, 94-107. (in Russian).
11. **Svetun'kov S.G., Svetun'kov I.S., 2010.** Methods of social and economic forecasting, Sainkt-Petersburg, Saint-Petersburg University of Economics and Finances, 103. (in Russian).
12. **Vasil'ev A.A., 2013.** Methods of selecting a coefficient of smoothing in forecasting Brown model. Tver, 183-196. (in Russian).
13. **Vasil'ev A.A., Vasil'eva E.V., 2013.** Study of forecasting Brown model with standard and over-extreme values of coefficient of smoothing. Tver, 197-213. (in Russian).
14. **Vartanyan V.M., Romanenkov Yu.A., Kononenko A.V., 2005.** Parametric synthesis of forecasting exponential smoothing model. Kharkiv, National Technical University Kharkiv Polytechnic Institute, 9-16. (in Russian).
15. **Vartanyan V.M., Romanenkov Yu.A., Kononenko A.V., 2007.** Adequacy analysis of forecasting models of company economic indexes. Kharkiv, Business Inform, 103-106. (in Russian).
16. **Svetun'kov S.G., 1997.** Over-extreme situations with Brown method. Ul'yanovsk, SVNC. (in Russian).
17. **Bobryshev A.N., Gun'ko A.Yu., 2010.** Usage of over-extreme multitude in Brown method. Financial bulletin Finances, Taxes, Insurance, Accounting, 16-20. (in Russian).
18. **Svetun'kov S.G., Butukhanov A.V., Svetun'kov I.S., 2006.** Over-extreme situations with Brown method in economic forecasting, Saint-Petersburg, Saint-Petersburg University of Economics and Finances, 71. (in Russian).
19. **Gurnovich T.G., Kosenko S.G., Toropcev E.L., 2007.** Practical application of Brown method for short-term forecasting of perfume and make-up market behavior. Krasnodar, Krasnodar Polythematic online scientific journal of Kuban State Agrarian University, 33-43. (in Russian).

#### АНАЛИЗ ПРОГНОЗНЫХ СВОЙСТВ МОДЕЛИ БРАУНА В РАСШИРЕННОЙ ОБЛАСТИ ВНУТРЕННЕГО ПАРАМЕТРА

**Аннотация.** Публикация посвящена анализу прогнозных свойств адаптивной модели Брауна в расширенной области внутренних параметров, относящемуся к классу задач параметрического синтеза прогнозных моделей, а именно оценке устойчивости прогнозных свойств модели к изменению внутренних параметров путем поиска областей робастности прогнозных оценок. Предложенный подход проиллюстрирован примером.

**Ключевые слова:** модель Брауна, экспоненциальное сглаживание, параметрический синтез прогнозной модели, робастность прогнозных оценок.

## Morphogenesis and correction of planar rod constructions with a small amount of free nodes

*Volodymyr Skochko*

Kyiv national university of construction and architecture  
Povitroflotskiy prosp., 31, Kyiv, Ukraine, 03680, e-mail: vladimir-skochko@yandex.ru

**Summary.** This publication is devoted to practical aspects of a new method of form correction of planar rod constructions. This method should be used after the initial shape of the frame construction is already defined. At the same time, suggested method makes it possible to determine the components of the stress-strain state of the construction and has the same mathematical foundation as a method of cutting out of nodes in theoretical mechanics. Also, the article demonstrates the principle of applying the method on the example of correction of form of elementary frame construction with hinge joint of rods. An example illustrates the advantages of this method over methods of numerical simulation, because it does not require changing of instrument base during the transition from automated shaping of construction to determination of efforts in its rods.

**Key words:** geometric modeling, discrete model, rod frame constructions, differential regularities, numerical simulations.

### INTRODUCTION

Most of the tasks of building mechanics involve determination of certain components of the stress-strain state (SSS) of constructions. It is assumed, that the geometrical parameters of structures are predetermined and represent the initial conditions for calculations. In the case, when before the calculations the morphogenesis process is carried out, it is necessary to apply two distinct methods: the first one – to determine the actual form of construction, the second one – to calculate the parameters of SSS.

At the present stage of development of computer aided design systems the most programs intended for calculation of con-

struction for strength and stability involve the ability to import finite data from the specialized software's environment for building of graphic models of these constructions. However, models that are products of graphics programs created directly by the users (architects, engineers, designers, etc.), while automated algorithms for morphogenesis of constructions in the environment of these programs are nearly absent. Should be added, that existing mathematical algorithms of morphogenesis of building structures do not have sufficient variability to describe the features of work of construction elements in the process of loading and operation with required accuracy.

All the above mentioned points to the need to prepare a theoretical and tool base to create a unified method of building structures shape modeling, with possibility of their adjustments and subsequent calculation of component of SSS of their elements.

One of the most pressing areas of this problem is the formation and modeling of the rod building structures' work. Rod constructions have an important place among building structures, because their designing requires from engineers a high level of skills and responsibility. They are used in the design of beam coatings, trusses and covering membranes, bearing and self-supporting frames of buildings, frame structures and many others.

In this publication we will consider the outlined problems in the context of researching and modeling of planar rod or frame structures with hinge joint of rods.



## PURPOSE OF WORK

Basic principles of morphogenesis problem solving and subsequent adjustment of mesh and rod constructions were presented in a series of works [1-5]. The main idea of described in these works method is to apply the fundamental differential patterns between geometric and physical parameters of network structures and external fields for systemic redistribution of interaction forces between their vertices [6]. At the same time, works have the generalizing character and dedicated to the realization of mathematical apparatus of morphogenesis on examples of universal models of network structure (such as discrete surfaces, as in [5]). Obvious, that for the application of the proposed method in the tasks of structural mechanics and mechanics of rod systems it is necessary to adapt it to some extent, taking into account the engineering specifics. Such an adaptation is the main purpose of this work.

## REVIEW OF PREVIOUS RESEARCHES

For a start, we present the basic provisions of the method, summarized in [6], and simplified for two-dimensional case.

Suppose there is some two-dimensional rod system with hinge joint in the free and basic (reference) nodes. We shall assume, that the known topological characteristics of the system (number and order of rods connection) and rigidity (stiffness) parameters of its rods  $\mathbf{n}_{i,j}$ , which are expressed by the ratios of the absolute values of longitudinal efforts in rods  $R_{i,j}$  and their lengths  $\delta_{i,j}$ :

$$\mathbf{n}_{i,j} = R_{i,j} / \delta_{i,j}. \quad (1)$$

It is known, that the equilibrium state of each node can be described, using the principle of cutting out of units by replacing each rod, that connects to the node, on corresponding resistance efforts. Omitting the projection of vectors of forces  $\bar{\mathfrak{S}}_i$ , acting on the node from the outside, and vectors of internal efforts  $\bar{R}_{i,j}$ , which cut off rods, on the coordinate axes, we obtain the following

system of equilibrium equations of arbitrary node (taking into consideration equality (1)):

$$\sum_{j=1}^n (s_j - s_i) \cdot \mathbf{n}_{i,j} + \bar{\mathfrak{S}}_i = 0, \quad (2)$$

where:  $s$  – generalizing designation of coordinates;  $n$  – quantity of uncommitted nodes of construction.

If we assume, that the rigidity parameters of rods  $\mathbf{n}_{i,j}$  and external load  $\bar{\mathfrak{S}}_i$  is predetermined, then system of equations of type (2), composed for all free nodes of rod construction, can be solved relative to coordinates of these nodes. In this way, the process of prior morphogenesis of construction can be implemented. Having the coordinates of nodes, and determining the length of rods, it is not difficult to calculate internal forces from formula (1).

To make it possible to determine appropriate rigidity parameters of rods  $\mathbf{n}_{i,j}$  during adjustment of position of nodes, and to be able to calculate internal forces, the system (2) should be supplemented by a system of parametric equations of rod's state. These equations have the following form:

1) for the rods, connecting two free nodes of construction ( $S_a$  and  $S_b$ ):

$$\sum_{i=1}^{m-1} \delta_{a,i}^2 \cdot \mathbf{n}_{a,i} + \chi \cdot \delta_{a,b}^2 \cdot \mathbf{n}_{a,b} + \sum_{j=1}^{n-1} \delta_{b,j}^2 \cdot \mathbf{n}_{b,j} - (\varphi_a + \varphi_b) + B_{a,b} = 0; \quad (3)$$

2) for the rods, that connect one free and one basic nodes ( $S_a$  and  $S_{ref}$ ):

$$\sum_{i=1}^{m-1} \delta_{a,i}^2 \cdot \mathbf{n}_{a,i} + \chi \cdot \delta_{a,ref}^2 \cdot \mathbf{n}_{a,ref} - \varphi_a + (R_{x_{ref}} \cdot x_{ref} + R_{y_{ref}} \cdot y_{ref}) + B_{a,ref} = 0, \quad (4)$$

where:  $m$  and  $n$  – number of nodes adjacent to the  $a$ -th and  $b$ -th (or  $ref$ -th) nodes,  $\chi$  – some non-negative constant;  $\varphi_a$  and  $\varphi_b$  – nodal values of the scalar potential (of the field of objective function),  $R_{ref}$  – values of efforts in the rods that are connected to the rocker bearing,  $B_{a,b}$  and  $B_{a,ref}$  – general oper-



ating constants of integration.

In a matrix form the process of forming and subsequent correction of rod construction shape can be described by following system:

$$\begin{cases} [s^p] = [\mathbf{K}^{p-1}]^{-1} \cdot (-[g^{p-1}] - [\mathfrak{S}^p]), \\ \{\mathbf{K}^p\} = [(\delta^p)^2]^{-1} \cdot (\{\varphi^{p-1}\} - \{\varphi^p\} + \\ + [(\delta^p)^2] \cdot \{\mathbf{K}^{p-1}\}). \end{cases} \quad (5)$$

Here:  $[s]$  – matrix of coordinates (with dimension  $k \times 2$ , where  $k$  – the quantity of nodes of the model),  $[g]$  – matrix of the boundary conditions (with dimension  $k \times 2$ ),  $[\mathfrak{S}]$  – matrix of external influences (with dimension  $k \times 2$ ),  $[\mathbf{K}]$  – matrix of stiffness parameters of rod structure (with dimension  $k \times k$ ),  $\{\mathbf{K}\}$  – column vector of stiffness parameters of rod structure,  $[\delta^2]$  – matrix of geometric parameters of rod structure (with dimension  $h \times h$ , where  $h$  – quantity of model's rods),  $\{\varphi\}$  – column vector of nodal values of the scalar potential,  $\{\varphi'\}$  – column vector of expected nodal parameters of the scalar potential,  $p$  – index corresponding to the current step of the iterative calculation.

Solving the system (5) (if necessary using iterative calculation), we define values of corrected parameters of rods rigidity and coordinate of nodes of the model.

### CORRECTING OF THE SHAPE OF ROD CONSTRUCTIONS

Changing the position of nodes, using model systems (5), must be carried out by replacing the current values of the scalar potential  $\varphi_i$  on expected values  $\varphi'_i$ . It is assumed, that external influence  $\mathfrak{S}_i$  is in gradient connection with the current scalar potential. However, in [7] was founded that this relationship is not required. Moreover, there is possible the variant of local correction of construction. In this case the potential  $\varphi_i$  should be corrected only in certain points of the model.

If we need to move the selected set of nodes in the individual order, each of these nodes will have the functions of the scalar potential. Thus, in each node, which exposed by moving, scalar potential value will be represented by its objective function. Obviously, the objective function value must decline to zero under the condition, that the coordinates of the node come near to values set by the engineer. Therefore, objective function of an arbitrary  $i$ -th node  $S_i$  should be presented in the form of its distance from a certain established point  $T$ :

$$\begin{aligned} \varphi_i = \varphi(S_i) = \zeta(x_i, y_i) = \\ = \vartheta \cdot ((x_T - x_i)^2 + (y_T - y_i)^2)^{1/2}. \end{aligned} \quad (6)$$

Here:  $\vartheta$  – coefficient, entered to effect on speed of convergence of the iterative calculation.

The value of the expected node potential will be zero:  $\varphi'_i = 0$ .

Let's consider the example of shape correction of elementary rod construction in the form of a planar frame, which consist of 2 rods and has 2 hinged-fixed reference node ( $A$  and  $B$ ) and only 1 free hinge node  $V$  with the given load  $\mathfrak{S}_V$  (see. Fig. 1,  $a$ ).

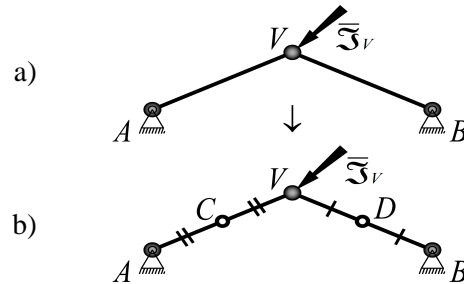

**Fig. 1.** The rod frames:  $a$  – frame AVB;  $b$  – frame ACVDB, obtained by adding nodes  $C$  and  $D$  to the frame AVB

This frame is statically undetectable. In addition, it can not be corrected, using the system (5). The fact is, that in order to properly influence to the changes of rigidity parameters of rods, using nodal potentials, in each parametric equation of rods of type (3)

or (4) must be contained various combinations of nodal potentials. In our case, the equations of rods  $AV$  and  $VB$  contain only potentials  $\varphi_V$  of node  $V$ . These equations have the following form:

$$\chi \cdot \delta_{A,V}^2 \cdot \mathfrak{N}_{A,V} + \delta_{V,B}^2 \cdot \mathfrak{N}_{V,B} - \varphi_V + (R_{x_A} \cdot x_A + R_{y_A} \cdot y_A) + B_{A,V} = 0, \quad (7)$$

$$\delta_{A,V}^2 \cdot \mathfrak{N}_{A,V} + \chi \cdot \delta_{V,B}^2 \cdot \mathfrak{N}_{V,B} - \varphi_V + (R_{x_B} \cdot x_B + R_{y_B} \cdot y_B) + B_{V,B} = 0. \quad (8)$$

From equations (7) and (8) we see, that when we change potential  $\varphi_V$ , then parameters  $\mathfrak{N}_{A,V}$  and  $\mathfrak{N}_{V,B}$  will change in direct proportion. In this case, the trajectory of the node  $V$  can not be controlled.

To make control of rigidity parameters of construction possible, we should halve rods  $AV$  and  $VB$  by additional nodes  $C$  and  $D$  respectively. We obtain the following relations:

$$\delta_{A,C} = \delta_{C,V} = \delta_{A,V}/2, \quad (9)$$

$$\delta_{V,D} = \delta_{D,B} = \delta_{V,B}/2. \quad (10)$$

The resulting structure is shown at Fig. 1.b.

Obviously, if any external forces will not act the additional nodes  $C$  and  $D$ , then internal forces in a rods  $AC$  and  $CV$ ,  $VD$  and  $DB$  will be equal and in fact will remain in solid segments  $AV$  and  $VB$ . That is:

$$R_{A,C} = R_{C,V} = R_{A,V}, \quad (11)$$

$$R_{V,D} = R_{D,B} = R_{V,B}. \quad (12)$$

Considering the equation (9) – (12), we write the relations between the stiffness parameters of rods  $AC$ ,  $CV$  and  $AV$ , as well as  $VD$ ,  $DB$  and  $VB$ :

$$\mathfrak{N}_{A,C} = \mathfrak{N}_{C,V} = 2 \cdot \mathfrak{N}_{A,V}, \quad (13)$$

$$\mathfrak{N}_{V,D} = \mathfrak{N}_{D,B} = 2 \cdot \mathfrak{N}_{V,B}. \quad (14)$$

Let's compose the equilibrium equations of type (2) for all free nodes ( $C$ ,  $V$  and  $D$ ):

$$\mathfrak{N}_{A,C} \cdot s_A + \mathfrak{N}_{C,V} \cdot s_V - (\mathfrak{N}_{A,C} + \mathfrak{N}_{C,V}) \cdot s_C = 0, \quad (15)$$

$$\mathfrak{N}_{C,V} \cdot s_C + \mathfrak{N}_{V,D} \cdot s_D - (\mathfrak{N}_{C,V} + \mathfrak{N}_{V,D}) \cdot s_V + \mathfrak{I}_{s_V} = 0, \quad (16)$$

$$\mathfrak{N}_{V,D} \cdot s_V + \mathfrak{N}_{D,B} \cdot s_B - (\mathfrak{N}_{V,D} + \mathfrak{N}_{D,B}) \cdot s_D = 0. \quad (17)$$

Rewrite equation (15) – (17), taking into account the identities (13) and (14) and all possible simplifications:

$$s_A - 2 \cdot s_C + s_V = 0, \quad (18)$$

$$\mathfrak{N}_{A,V} \cdot s_C + \mathfrak{N}_{V,B} \cdot s_D - (\mathfrak{N}_{A,V} + \mathfrak{N}_{V,B}) \cdot s_V + \mathfrak{I}_{s_V}/2 = 0, \quad (19)$$

$$s_V - 2 \cdot s_D + s_B = 0. \quad (20)$$

Now we compose system of parametric equations of state for rods  $AC$ ,  $CV$ ,  $VD$  and  $DB$ :

$$\chi \cdot \delta_{A,C}^2 \cdot \mathfrak{N}_{A,C} + \delta_{C,V}^2 \cdot \mathfrak{N}_{C,V} - \varphi_C + (R_{x_A} \cdot x_A + R_{y_A} \cdot y_A) + B_{A,C} = 0, \quad (21)$$

$$\delta_{A,C}^2 \cdot \mathfrak{N}_{A,C} + \chi \cdot \delta_{C,V}^2 \cdot \mathfrak{N}_{C,V} + \delta_{V,D}^2 \cdot \mathfrak{N}_{V,D} - (\varphi_C + \varphi_V) = 0, \quad (22)$$

$$\delta_{C,V}^2 \cdot \mathfrak{N}_{C,V} + \chi \cdot \delta_{V,D}^2 \cdot \mathfrak{N}_{V,D} + \delta_{D,B}^2 \cdot \mathfrak{N}_{D,B} - (\varphi_V + \varphi_D) = 0, \quad (23)$$

$$\delta_{V,D}^2 \cdot \mathfrak{N}_{V,D} + \chi \cdot \delta_{D,B}^2 \cdot \mathfrak{N}_{D,B} - \varphi_D + (R_{x_B} \cdot x_B + R_{y_B} \cdot y_B) + B_{D,B} = 0. \quad (24)$$

We shall add pairs of equations (21) with (22) and (23) with (24), given the identity (9), (10), (13) and (14), setting the coefficient  $\chi = 2$  (according to [2], since as quantity of model's nodes is higher than the quantity of rods), and performing all possible simplification:

$$3 \cdot \delta_{A,V}^2 \cdot \mathfrak{N}_{A,V} + (1/2) \cdot \delta_{V,B}^2 \cdot \mathfrak{N}_{V,B} - (2 \cdot \varphi_C + \varphi_V) + (R_{x_A} \cdot x_A + R_{y_A} \cdot y_A) + B_{A,C} = 0, \quad (25)$$

$$(1/2) \cdot \delta_{A,V}^2 \cdot \mathfrak{N}_{A,V} + 3 \cdot \delta_{V,B}^2 \cdot \mathfrak{N}_{V,B} - (\varphi_V + 2 \cdot \varphi_D) + (R_{x_B} \cdot x_B + R_{y_B} \cdot y_B) + B_{D,B} = 0. \quad (26)$$

Using equations (18)-(20), we write the components of the first expression of system (5). They will have the following form:

1. The matrix of coordinates  $[s]$ :

$$[s] = [X \quad Y], \quad (27)$$

where:  $\{X\}$  and  $\{Y\}$  – column vectors of coordinates of nodes, which have the form:

$$\{X\}^T = [x_C \quad x_V \quad x_D], \quad (28)$$

$$\{Y\}^T = [y_C \quad y_V \quad y_D]. \quad (29)$$

2. The matrix of boundary conditions  $[g]$ :

$$[g] = [g_x \quad g_y], \quad (30)$$

where:  $\{g_x\}$  and  $\{g_y\}$  – column vectors of boundary conditions, which have the form:

$$\{g_x\}^T = [-I \cdot x_A \quad 0 \quad -I \cdot x_B], \quad (31)$$

$$\{g_y\}^T = [-I \cdot y_A \quad 0 \quad -I \cdot y_B]. \quad (32)$$

3. The matrix of external forces  $[\mathfrak{S}]$ :

$$[\mathfrak{S}] = [\mathfrak{S}_x \quad \mathfrak{S}_y], \quad (33)$$

where:  $\{\mathfrak{S}_x\}$  and  $\{\mathfrak{S}_y\}$  – column vectors of external forces, which have the form:

$$\{\mathfrak{S}_x\}^T = [0 \quad \mathfrak{S}_{x_V}/2 \quad 0], \quad (34)$$

$$\{\mathfrak{S}_y\}^T = [0 \quad \mathfrak{S}_{y_V}/2 \quad 0]. \quad (35)$$

4. The matrix of stiffness parameters  $[\mathfrak{N}]$ :

$$[\mathfrak{N}] = \begin{bmatrix} -2 & I & 0 \\ \mathfrak{N}_{A,V} & -(\mathfrak{N}_{A,V} + \mathfrak{N}_{V,B}) & \mathfrak{N}_{V,B} \\ 0 & I & -2 \end{bmatrix}. \quad (36)$$

Now, on the basis of equations (25) and (26) we can write the components of the second expression of system (5). They will have the following form:

1. The column vector of stiffness parameters of rod construction  $\{\mathfrak{N}\}$ :

$$\{\mathfrak{N}\}^T = [\mathfrak{N}_{A,V} \quad \mathfrak{N}_{V,B}]. \quad (37)$$

2. The matrix of geometric parameters of rod structure  $[\delta^2]$ :

$$[\delta^2] = \begin{bmatrix} 3 \cdot \delta_{A,V}^2 & (1/2) \cdot \delta_{V,B}^2 \\ (1/2) \cdot \delta_{A,V}^2 & 3 \cdot \delta_{V,B}^2 \end{bmatrix}. \quad (38)$$

3. The column vector of expected nodal potentials  $\{\varphi'\}$ :

$$\{\varphi'\}^T = [\varphi'_{A,V} \quad \varphi'_{V,B}] = [0 \quad 0]. \quad (39)$$

4. The column vector of current nodal potentials  $\{\varphi\}$ :

$$\{\varphi\}^T = [\varphi_{A,V} \quad \varphi_{V,B}] = [2 \cdot \varphi_C + \varphi_V \quad \varphi_V + 2 \cdot \varphi_D]. \quad (40)$$

Call attention to the elements of the column vector  $\{\varphi\}$ . If one follows an algorithm of application of the system (5) and choose as an objective functions the distances of type (6), then in case of the unsuccessful selection of coefficient  $\vartheta$  and low value of calculation error iterative calculation may be divergent. This can happen, because at the stage close to achieving nodes of their planned coordinates, displacement step of one of the nodes will exceed a distance to the point of his appointment. At the same time algorithm (5) will try to shorten the distance of a particular node to the established point by subsequent replacement of potentials (objective functions) "without realizing a miss". This will only lead to further distancing of the node from its destination.

To avoid the described effect, should use as a coefficient  $\vartheta$  not a constant but logical operator. The operator  $\vartheta$  must analyze the differences  $\Delta\varphi$  between elements of the col-

umn vector of potentials  $\{\varphi\}$  on the current and previous steps of iterative calculation:

$$\Delta\varphi_{i,j}^p = \varphi_{i,j}^p - \varphi_{i,j}^{p-1}. \quad (41)$$

Thus, the value of operator  $\vartheta$  should be determined by the expression:

$$\vartheta_{i,j}^p = \zeta(\Delta\varphi_{i,j}^p) = \begin{cases} 1 & \text{if } \Delta\varphi_{i,j}^p > 0, \\ 0 & \text{if } \Delta\varphi_{i,j}^p = 0, \\ -1 & \text{if } \Delta\varphi_{i,j}^p < 0. \end{cases} \quad (42)$$

This character of dependence of function from the values of the argument can be described by hyperbolic tangent of the argument (such as logical operators used in neural modeling [11-13]). Such continuous function will look like:

$$\begin{aligned} \vartheta_{i,j}^p &= \zeta(\Delta\varphi_{i,j}^p) = \tanh\left(\alpha \cdot \Delta\varphi_{i,j}^p / 2\right) = \\ &= \frac{1 - \exp(-\alpha \cdot \Delta\varphi_{i,j}^p)}{1 + \exp(-\alpha \cdot \Delta\varphi_{i,j}^p)}, \end{aligned} \quad (43)$$

where:  $\alpha$  – coefficient, whose value determines the sharpness of the character changing of the function (43) during the transition from  $-1$  to  $1$  (through  $0$ ).

Therefore, the column vector of the current potentials  $\{\varphi^p\}$ , which will take into account the values of each component at the previous step of calculation, will have the following form:

$$\begin{aligned} \{\varphi^p\}^T &= [\vartheta_{A,V}^p \cdot \varphi_{A,V}^p \quad \vartheta_{V,B}^p \cdot \varphi_{V,B}^p] = \\ &= [\vartheta_{A,V}^p \cdot (2 \cdot \varphi_C^p + \varphi_V^p) \quad \vartheta_{V,B}^p \cdot (\varphi_V^p + 2 \cdot \varphi_D^p)]. \end{aligned} \quad (44)$$

Let us consider the objective functions that make up the column vector  $\{\varphi^p\}$ .

Obviously, for the node  $V$  the function  $\varphi_V$  is defined as a distance to a certain established point  $T$  (using formula (6)):

$$\varphi_V = ((x_T - x_V)^2 + (y_T - y_V)^2)^{1/2}. \quad (45)$$

Here, we don't have to use the coefficient  $\vartheta$ , because it is already counted as a logical

operator in the expression (44).

For nodes  $C$  and  $D$  objective functions can no longer be defined as the distances to the centers of segments  $AT$  and  $TB$ , because these distances are always equal (see. Fig. 2).

For the selection of objective functions of scalar potential in nodes  $C$  and  $D$  we will use the following fact. Obviously, in case of coincidence of node  $V$  with point  $T$ , vertices of triangles  $ACT$  and  $BDT$  will be placed on straight lengths  $AT(V)$  and  $BT(V)$  respectively. Then will be valid the following equations:

$$AT = AC + CT, \quad (46)$$

$$BT = AD + DT. \quad (47)$$

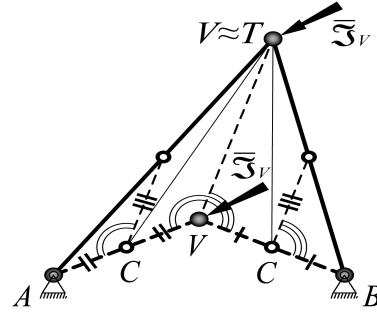

**Fig. 2.** The rod frame  $ACVDB$ :

- 1) at the moment of formation (dashed);
- 2) in corrected state (solid)

However, until the equalities (46) and (47) are not valid, iterative calculation should be continued. The values, that will characterize proximity to the completion of the calculation, will be objective function in the nodes  $C$  and  $D$ . The following differences will be served by them:

$$\begin{aligned} \varphi_C &= AT - (AC + CT) = \\ &= ((x_T - x_A)^2 + (y_T - y_A)^2)^{1/2} - \\ &- ((x_C - x_A)^2 + (y_C - y_A)^2)^{1/2} - \\ &- ((x_T - x_C)^2 + (y_T - y_C)^2)^{1/2}, \end{aligned} \quad (48)$$

$$\begin{aligned} \varphi_D &= BT - (BD + DT) = \\ &= ((x_T - x_B)^2 + (y_T - y_B)^2)^{1/2} - \\ &- ((x_D - x_B)^2 + (y_D - y_B)^2)^{1/2} - \\ &- ((x_T - x_D)^2 + (y_T - y_D)^2)^{1/2}. \end{aligned} \quad (49)$$

Should be added, that algorithmic implementation of the system (5) can be somewhat simplified by excluding the coordinates of fictitious nodes  $C$  and  $D$  from the calculating process. To do this we have to make two steps:

1) to bring the system (18) – (20) to the static equations describing the equilibrium of node  $V$  only:

$$\begin{aligned} \mathbf{n}_{A,V} \cdot s_A + \mathbf{n}_{V,B} \cdot s_B - \\ - (\mathbf{n}_{A,V} + \mathbf{n}_{V,B}) \cdot s_V + \mathfrak{S}_{sV} = 0, \end{aligned} \quad (50)$$

from where we can easily determine the coordinates of node  $V$ .

2) to rewrite the formulas (48) and (49), taking into account equations (18) and (20):

$$\begin{aligned} \varphi_C &= ((x_T - x_A)^2 + (y_T - y_A)^2)^{1/2} - \\ &- \left( \left( \frac{x_A + x_V}{2} - x_A \right)^2 + \left( \frac{y_A + y_V}{2} - y_A \right)^2 \right)^{1/2} - \end{aligned} \quad (51)$$

$$\begin{aligned} - \left( \left( x_T - \frac{x_A + x_V}{2} \right)^2 + \left( y_T - \frac{y_A + y_V}{2} \right)^2 \right)^{1/2}, \end{aligned}$$

$$\begin{aligned} \varphi_D &= ((x_T - x_B)^2 + (y_T - y_B)^2)^{1/2} - \\ &- \left( \left( \frac{x_V + x_B}{2} - x_B \right)^2 + \left( \frac{y_V + y_B}{2} - y_B \right)^2 \right)^{1/2} - \end{aligned} \quad (52)$$

$$\begin{aligned} - \left( \left( x_T - \frac{x_V + x_B}{2} \right)^2 + \left( y_T - \frac{y_V + y_B}{2} \right)^2 \right)^{1/2}. \end{aligned}$$

The values of internal forces in the rods of construction can be determined from the formula (1):

$$R_{i,j} = \mathbf{n}_{i,j} \cdot \delta_{i,j}. \quad (53)$$

Let's consider a few options of determining the components of SSS of rod frame  $ACVDB$ .

The values of the load vector, which act-

ing on node  $V$ , the value the initial rigidity parameters of the frame, as well as rigidity parameters, nodes coordinates and internal efforts after adjustment of position of node  $V$ , are shown in Table 1. The initial and corrected frames are shown in Figure 3.

**Table 1**

Parameters of SSS of the frame		The load in the node $V$		
		$\mathfrak{S}_{xV} = -1$	$\mathfrak{S}_{yV} = -1$	$\mathfrak{S}_{sV} = 2$
Variant $\rightarrow$		a)	b)	c)
Incoming	$x_A$	1	2	1
	$x_B$	5	5	5
	$x_T$	3	4	1
	$y_A$	1	3	1
	$y_B$	1	1	1
	$y_T$	6	6	5
	$\mathbf{n}_{A,V}$	-1	-2	-1
	$\mathbf{n}_{V,B}$	-1	-2	-1
Iterations		150	250	150
Calculated	$x_C$	2.00001	3.00216	1.00159
	$x_V$	3.00003	4.00433	1.00318
	$x_D$	4.00001	4.50216	3.00159
	$y_C$	3.49998	4.4961	2.99946
	$y_V$	5.99995	5.99219	4.99893
	$y_D$	3.49998	3.4961	2.99946
	$\mathbf{n}_{A,V}$	-0.35	-0.46085	0.25007
	$\mathbf{n}_{V,B}$	0.15	0.07594	-0.50023
	$R_{A,V}$	-1.8848	-1.65975	1.00002
$R_{V,B}$	0.80776	0.38657	-2.82822	

## CONCLUSIONS

Demonstrated method allows not only to correct the shape of pre-formed structures, but also to determine its internal efforts in the rods. At the same time shown approach to choice potential objective functions can be greatly varied, giving scope for the ingenuity of engineers and researchers. In addition, it is possible to use logical operators in correcting the position of nodes of constructions.

All of these provides for the possibility of application of the suggested method not only in tasks of theoretical and structural mechanics, but also in other fields of science and technology.

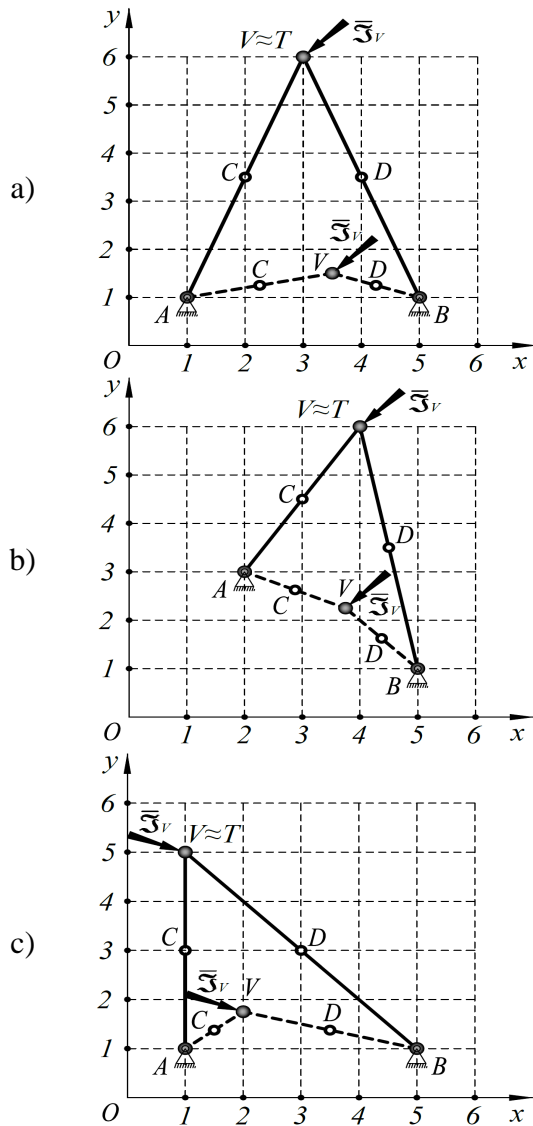

**Fig. 3.** Variants of frames ACVDB, formed under given in Table 1 input parameters and after correction

REFERENCES

1. **Skochko V., Skochko L., 2012/2013.** The Differential Laws Between the Geometrical and Physical Parameters of the Mashers and the Fields, which Balance Them. Kyiv, Base and Foundations No 33, 85-95.
2. **Skochko V., Skochko L., 2013.** The Equation of State and Condition Parameters of the Mesh Structure Relationships. Kyiv, Base and Foundations No 34, 47-57.
3. **Skochko V., 2014.** The Equation of State Parameters and Position of the Ligature Connecting Free and Fixed Nodes of Network Structure. Kyiv, Urban Development and Ter-

- itorial Planning No 51, 521-527.
4. **Skochko V., 2014.** The Equation of State Parameters and Corresponding Computational Templates for Ligature of Regular Two-dimensional Grids. Kyiv, Applied Geometry, Design and Innovative Activity №2, 192-197.
5. **Ploskiy O., Skochko V., 2014.** The Discrete Cages of Surfaces Constructing Using Equations of State's Parameters and Conditions of the Mesh Structure's Communications. Lutsk, Advances in Mechanical Engineering and Transport No 2, 94-103.
6. **Ploskiy O., Skochko V., 2014.** Algorithm of Meshwork's Communications Controlling Based on Adjustment of the Scalar Potential of External Influences. Kyiv, Energy Efficiency in the Construction and Architecture No 6, 224-230.
7. **Kulikov P., Ploskiy O., Skochko V., 2014.** The Principles of Discrete Modeling of Rod Constructions of Architectural Objects. Lublin-Rzeszow, Motrol: Commission of Motorization and Energetics in Agriculture, Polish Academy of Sciences, Vol. 16 (8), 3-10.
8. **Chybiryakov V., Stankevich A., Levkivskiy D., Melnychuk V., 2014.** Application of Generalized "Method of Lines", for Solving Problems of Thermoelectricity of Thick Plates. Lublin-Rzeszow, Motrol: Commission of Motorization and Energetics in Agriculture, Polish Academy of Sciences, Vol. 16 (8), 11-20.
9. **Sakharov V., Zhuk V., Skochko L., 2014.** Interaction Study of the Frame Building with Foundation Weakened by the Underground Mines under the Seismic Load. Lublin-Rzeszow, Motrol: Commission of Motorization and Energetics in Agriculture, Polish Academy of Sciences, Vol. 16 (8), 37-44.
10. **Bazhenov V., Pyskunov S. 2014.** A Finite Element Technique and Results of Continual Fracture Process Modelling. Lublin-Rzeszow, Motrol: Commission of Motorization and Energetics in Agriculture, Polish Academy of Sciences, Vol. 16 (8), 21-28.
11. **Haykin S., 2006.** Neural Networks. A Comprehensive Foundation. Upper Saddle River – New Jersey, 1105.
12. **Rosenblatt F., 1962.** Principles of Neurodynamics. Perceptrons and the Theory of Brain Mechanisms. Spartan Books, Washington, D.C., 470.
13. **Narendra K., Amnasway A., 1988.** A Stable Adaptive Systems. Prentice-Hall, 350.

ФОРМООБРАЗОВАНИЕ И КОРРЕКЦИЯ  
ПЛОСКИХ СТЕРЖНЕВЫХ КОНСТРУКЦИЙ  
С НЕБОЛЬШИМ КОЛИЧЕСТВОМ  
СВОБОДНЫХ УЗЛОВ

**Аннотация.** Публикация освещает практические аспекты метода корректировки формы плоских стержневых конструкций, который следует применять после их предварительного формообразования. Метод позволяет определять компоненты напряженно-деформированного состояния конструкции и имеет ту же математическую основу, что и метод вырезания узлов теоретической меха-

ики. Также, в статье продемонстрирован принцип использования метода на примере корректировки формы элементарной конструкции с шарнирным соединением стержней. Пример показывает преимущества данного метода над методами численного моделирования, так как не требует смены инструментальной базы при переходе от формообразования конструкции к определению усилий в её стержнях.

**Ключевые слова:** геометрическое моделирование, дискретная модель, стержневые рамные конструкции, дифференциальные закономерности, численное моделирование.





## The influence of longitudinal slope of main road carriage-way on the mass emission from road transport in the atmospheric air

Igor Solukha

Kyiv National University of Construction and Architecture  
Povitroflotskyy prosp., 31, Kyiv, Ukraine, 03680, e-mail: igorsoluha@ukr.net

**Summary. Relevance:** the issue of the impact of longitudinal slope of the street, as geometrical parameter of carriage-way, on mass emission of pollutants from motor transport is raised. **The tasks of research:** consider the concepts of longitudinal street slopes, discharge, exhaust gas, mass emission, atmospheric air. **The technique of research:** the theoretical technique of analysis for determining the role of longitudinal slope of a carriage-way on the adoption of engineering and planning decision of main roads intersection is implied. **The results of research:** the interdependence of the mass emission of pollutants into the atmospheric air from road transport and slope of a carriage-way was established. **Conclusions:** It was established that with increasing slope mass emission of pollutants may grow 3...15 times as many.

**Key words:** longitudinal slope, mass emission, atmospheric air.

### GLOSSARY

*Atmospheric air* – a vital component of the natural environment, which is a mixture of natural gas, which is located outside of residential, industrial and other facilities.

*Discharge* – intake of pollutants or mixtures of these substances into the atmospheric air.

*Exhaust gas* (gas that comes out of tailpipes of motor vehicle) – spent working substance in heat engine. This is a product of

oxidation and incomplete combustion of hydrocarbon or other fuels. Exhaust gases contain a certain amount (depending on a fuel type of engine and its technical condition) of toxic and harmful components.

*Sources of pollutants emissions* – the facility where the air contaminant or mixture of these substances come from.

*Contaminant* – substance of chemical or biological origin that is present or comes into the atmospheric air and can directly or indirectly exert a negative impact on health and the natural environment.

*Longitudinal slope* – a tangent of inclination angle line of the street to the horizontal plane at the given point.

### INTRODUCTION

Longitudinal street slopes, which form a part of transportation planning junction to street and road network of the city, determine the choice of constructive decisions and the geometrical sizes of overpass and with all other factors of placing it in the plan. Depending on the nature of longitudinal profiles of the streets that are compounds of a conjunction, slopes directions and their rates, the question of the vertical planning of junction crossing of main road at the one and different levels is also settled.

Depending on the size and the negative, zero or positive values of the longitudinal slope of street, exit and flyover (when it comes to the junction crossing at different levels), mode of operation of the internal combustion engine vehicle changes and consequently pollutant mass emission in the atmospheric air from the road traffic in general changes too [1, 18].

### BASIC MATERIALS SUMMARY

Longitudinal slope is determined due to paragraph 2.27 of DBN V.2.3-5-2001 of “Design standard of streets longitudinal profile according to their categories and the estimated speed of movement should be accepted according to Table 2.8” where the biggest longitudinal slope is accepted from 40 ‰ to 80 ‰, depending on the estimated speed of traffic on the SRN of city streets (Fig. 1) and due to paragraph 2.29 of DBN V.2.3-5-2001 longitudinal slopes of streets should be determined depending on the types of road surfaces by the table 2. 9. According to which slope varies from 5 ‰, and for the reconstruction conditions varies from 4 ‰ to 100 ‰, exceptionally 110 ‰ depending on the type of road surface of the street [3, 4].

Size of longitudinal slope of its individual

sections, the radii of vertical curves that connect these areas, high-altitude position of its carriageway relative to the earth’s surface is characterized by longitudinal profile of main road.

Longitudinal profile describes the steepness at each part of the street. The natural slopes of the relief may exceed permissible for streets. In this case, the relief is changed by earth excavation.

Selection of a longitudinal profile of the road affects the safety, speed, efficiency of the vehicle and mass emission of pollutants in the atmospheric air. Therefore, technical standards should be kept during the construction of streets and intersectional junctions of main road. These standards set the value of the largest slopes and determine the conditions of profile connection on the fractures. Moreover, all the conditions for a smooth and safe traffic creation with minimum construction cost are taken into account. Street line is divided into the kilometers and the hundred-metre areas called pickets for better orientation.

Longitudinal slope of the street may coincide with the curve in the plan, therefore it has a small radius. In this case, the conditions of the vehicular traffic get more complex. The slope of the carriage-way of street on the curves depends on the

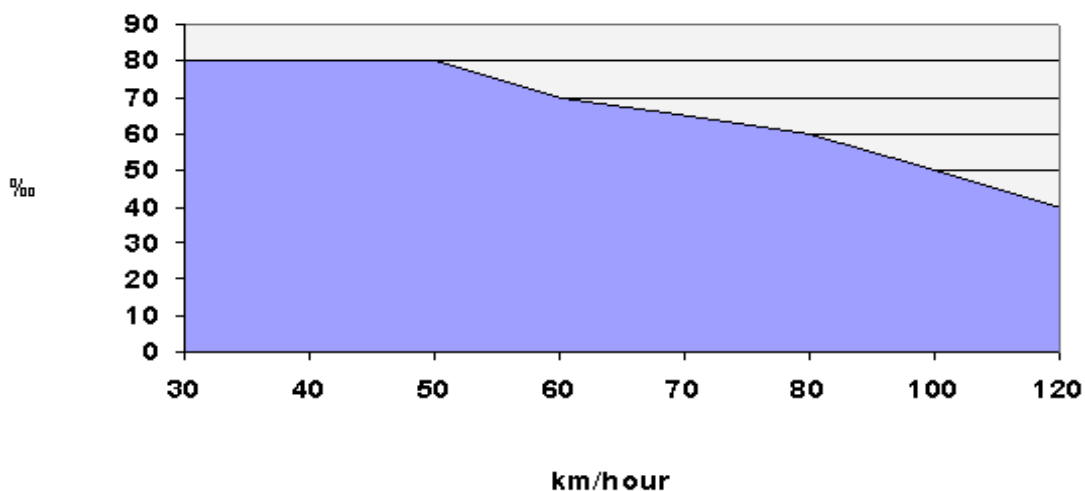

**Fig. 1** The relationship between the calculated speed and the largest longitudinal slope in accordance with paragraph 2.27 of DBN V.2.3-5-2001

longitudinal and transversal slopes. The slope of a steep turn favours transport slip, which is slow-moving or brakes on slippery surfaces.

When there are concave longitudinal profiles of main roads that intersect, or at least one concave profile, the construction of intersectional junction of city main roads at different levels would be most appropriate. In this case, the intersection is achieved compactness and reduced length approaches to artificial structures. As a result mileage of turning traffic streams within intersection is reduced. The intersection with the construction of an overpass with the concave longitudinal profiles requires considerable lengths of approaches and increase of the total area of intersection. In this case overpass in terms of architectural and composite solution is usually inappropriate. Concave longitudinal profile of main roads that intersect determine to a large extent the feasibility of using of tunnel solution because the compactness of intersections is provided in so doing and, as a rule, it is also advantageous from technical and economic considerations.

Overpass and tunnel may be created on the flat terrain. In this case, hydrological conditions or technical and economic considerations can be crucial.

In some cases, it is allowed to change the standard value of longitudinal slopes (values higher than recommended for main roads are taken) for reducing the area occupied by the intersection of main roads at different levels and the radius of vertical curves (values less than recommended are taken) can also be changed. So the rational values of longitudinal slopes and the radii of vertical curves are determined by the selection.

After placing exits in plan the validation of longitudinal slopes is made. In the vertical

planning of exits the basic condition is to ensure optimal longitudinal slope. On the straight sections the longitudinal slopes of exits must not exceed the maximum allowable values of deviations for main roads that intersect. If it is necessary, longitudinal slopes of exits are allowed to be 10 ‰ larger than the largest allowable slope on main directions of the main roads. Within rounding of exits, starting with a radius of 50 m, the boundary longitudinal slopes should be reduced. With 50 m size of radius boundary value is reduced to 10 ‰, and for every additional reduction by 5 m in the value of the radius of rounding, the boundary value of longitudinal slope should be further reduced by 5 ‰.

Studying existing "methods of calculating mass emissions of pollutants into the atmospheric air from automobile transport" theoretical studies were developed regarding the influence of longitudinal slope of the street on mode of operation of internal combustion engine and as a result on the mass emission of pollutants into the atmospheric air from car and motor stream on the whole.

According to existing methods of calculating of mass emission of pollutants and greenhouse gases into the atmosphere from vehicles dependence  $g_{ijk}(V)$  on the slope ( $S$ ) is set by slope coefficient  $C_s = C_{ijk}(S)$  in tabular form for the range  $-6...0...+6\%$ . The product of  $g_{ijk}(V) * C_s$  forms a part of the general formula for determining the mass emission. Type of curve  $C(S)$  is for the same type of emission ingredients of  $jk$  – vehicles (except  $C_xH_y$ ). The function makes a unity on a smooth road ( $S = 0\%$ ), has a relatively gentle part on slopes and a significant slope on rise of the road. Typical dependence  $C(S)$  for diesel vehicles is shown in Fig. 2 [14-17, 19].

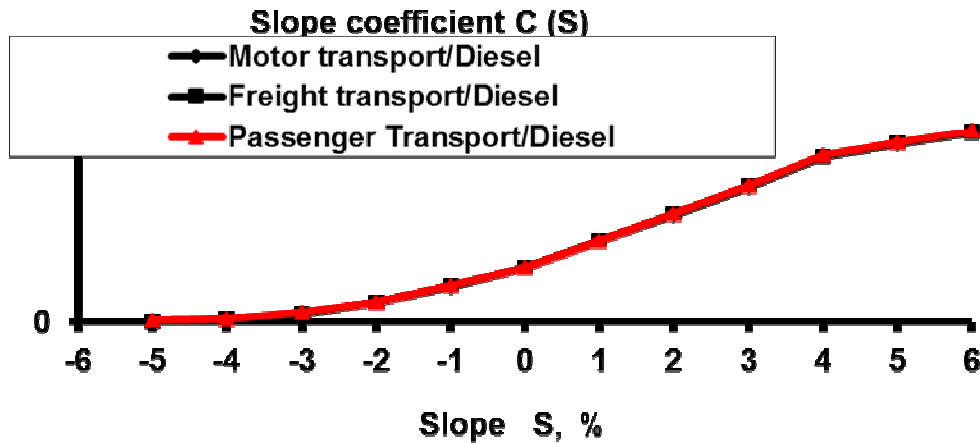

**Fig. 2** Typical dependence of specific soot emissions  $C$  produced by diesel vehicles on the slope  $C (S)$

With increasing of the slope from 0 to 5% the emissions of  $NO_2$  and  $CO$  can be 3 ... 15 times as many. The increase of emissions of hydrocarbons  $C_xH_y$  on slopes is due to the release of undeveloped fuel [5].

The increase of the slope from 0 to 3% causes growth 5...7 times as many maximum single concentration  $C_xH_y$ ,  $C$ ,  $NO_2$  with possible exceeding of hygienic norms.  $N_{critical} = 500$  cars/h with a slope of 3% due to the criterion the maximum single boundary permissible concentration (BPC) of  $NO_2$ .

Influence on main roadside territory is highly dependent on the slope of the road where  $NO_2$  emissions could increase 6 ... 7 times as many (Fig. 3, Tab. 1) [9-13, 19].

Traffic intensity in two directions (two lanes), when there is no excess of BPC. ms

at the distance of 7,5...30,0 m from the curb.

**Table 1.** Dependence of traffic intensity of transport stream on traffic conditions and longitudinal slope of the roadway

Vehicle traffic terms	Safe traffic intensity, units / hour	
	slope 0%	slope of 3%
Zone before lights	125...500	75...300
Free traffic between intersections	250...1000	125...500
Free traffic on overpass	2000...10000	

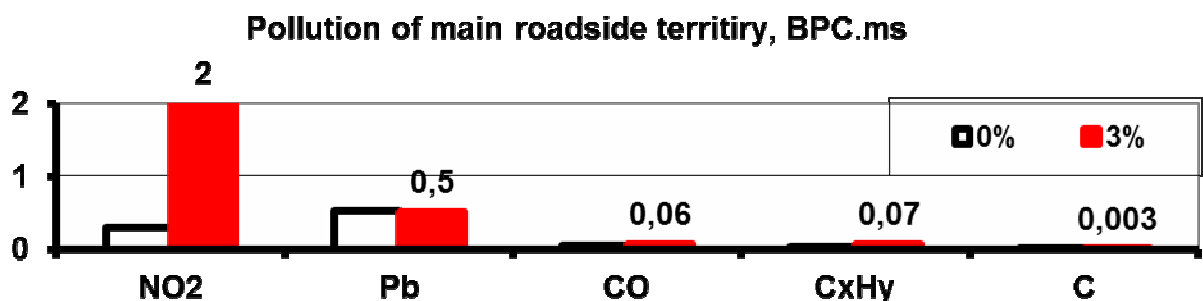

**Fig. 3** Maximum single (MS) concentration of emission in 30 meters from the curb of the roadway when there is a traffic of 1000 cars/h on a smooth road (0%) and slope (3%)

Pollution of the roadside territory from the multilevel interchanges is due to these factors: the level of traffic intensity; change in speed limits and consequently change in specific emission at different speeds; the rise of one of the main streams on overpass; slope at the expense of the difference of heights 6...7 m between directions; over mileage of the left-turning streams [1-2, 6-8].

Specific emissions of pollutants into the atmospheric air are used for calculation of emissions of pollutants from motor vehicles from consumption of one ton of fuel and influence coefficient of the technical state of vehicles on them, according to the State Statistics Service Procedures. Calculation of air pollutants from fuel use from motor transports is made due to the formula (1):

$$B_{jikm} = M_{ikm} \cdot G_{jik} \cdot K_{jik}, \quad (1)$$

where:  $B_{jikm}$  – amount of j-th pollutant from i-th consumed fuel of k-th type of group of m-th vehicle of business entity;  $M_{ikm}$  – amount of i-th consumed fuel of k-th type of group of m-th vehicle of business entity;  $G_{jik}$  – j-th specific emissions of pollutant from consumption of i-th fuel of k-th type by group of motor vehicles of business entity;  $K_{jik}$  – coefficient of the technical state influence on specific emissions of pollutant (except lead) from the use of i-th fuel type of k-th group of vehicles.

The proposed "Model of dependence of the mass emission from road transport on geometrical parameters of road junction at different levels, such as slope and radius of curves in the plan," is compared with methodology currently in force in accordance with the order №452, 13.11.2008. "On approval of the methodology of the pollutants emission and greenhouse gases calculation into the atmosphere from vehicles "[State Statistics Service of Ukraine, 2008] intended for the calculation of statistical data (tons/year) for the country on the whole, using software" EOL".

Due to the proposed model of dependence of the mass emission from road transport on geometrical parameters of road junctions at different levels, such as slope and radius of curves in plan, maximum single mass emission of  $M_{ijk}$  i-th substance from j-th vehicles type with k-th engine type from the one planar source  $D$  is determined in "rush-hour" using the formula (2):

$$M_{ijk} = \frac{N_0 \cdot N_{jk} \cdot g_{ijk}(V_{jk}) \cdot T_{jk}(V_{jk}) \cdot C_s \cdot C_f \cdot C_T}{3600}, \quad (2)$$

where:  $M_{ijk}$  – mass emission of i-th substance from j-th type with k-th engine type in "rush-hour", g/s,  $N_0$  – the total number of vehicles in one direction, natural units/"rush-hour",  $N_{jk}$  – jk-share vehicles in the flow, particle NO,  $g_{ijk}$  – specific emission of i-th substance from jk-vehicles, g/s,  $g_{ijk}(V_{jk})$  –  $g_{ijk}$  dependence of the current speed  $V_{jk}$ , g/s,  $T_{jk}(V_{jk})$  – the duration of motor operation of a jk-vehicle in "rush-hour" at a fixed  $V_{jk}$ , s,  $C_s$  – coefficient of influence of the road slope,  $C_f$  – coefficient of impact resistance of the movement,  $C_T$  – coefficient of technical state of vehicles.

The total number of vehicles in one direction  $N_0$  (natural units/"rush-hour") is determined separately for each source  $D$ . In formulae  $N_0$  is only in physical units (natural units/"rush-hour").  $g_{ijk}(V_{jk})$  dependence is submitted in tabular form for the range 0...90 km / h.  $V_{jk}(t)$  may be different for  $D_1... D_m$  sources.  $T_{jk}(V_{jk})$  of one car during "rush-hour" at a fixed  $V_{jk}$  is calculated separately for each  $D$  sources with different modes of motion. Coefficients  $C_s$  and  $C_f$  are specific to each  $D$  source as slope and road surface may vary. Coefficient of influence of the technical state of vehicles and its control, the average age of the fleet  $C_T$  are determined in the complex circuit of city transport (CCT). For example,  $C_T = 1$  to 2005, and thereafter  $C_T = 0,689$  are taken for Kyiv [19-22].

We apply the proposed model to optimize the choice of the longitudinal slope of intersectional junction elements of the main road at different levels in terms of traffic interchange at the intersection of boulevard Druzhby Narodiv and Naddnipryanskoho shose in Pecherskuy rayon in Kyiv using mass dependence of pollutant emissions from longitudinal slope coefficient of each individual source. We expect a decrease in pollutants mass into the atmosphere from road transport through optimal ratios of the longitudinal slope. We get the following results on the total mass of pollutants in the air in concordance with methodology in force according to the order №452, 13.11.2008. "On approving the methodology for determining of pollutants and greenhouse gases emissions into the atmospheric air from vehicles" [State Statistics Service of Ukraine, 2008 ] intended for determination of statistic data (tons/year) for the country on the whole, along with using the software "EOL" and according to the proposed model of dependence of mass emission from road transport on geometrical parameters of main road intersection at different levels, such as slope and radius curves in plan (Tab. 2).

**Table 2.** Comparing the results of calculations of pollutants mass into the atmospheric air

Ingredients	Mark.	EOL	Model	Difference
		g/s	g/s	%
Nitrogen dioxide	NO <sub>2</sub>	0,8431	0,84008	0,35
Carbon monoxide	CO	5,7384	5,71494	0,41
Hydrocarbons	C <sub>12</sub> - C <sub>19</sub>	0,8086	0,8058	0,35
Total		7,3901	7,36082	

## CONCLUSIONS

1. Vertical planning of main road intersectional junction at different levels depending on the nature of longitudinal profiles, slopes directions and their rates.

2. Longitudinal slope of the streets are taken mainly by 2.27 and 2.29 paragraphs of DBN V.2.3-5-2001 depending on the type of street category and road surface.

3. Longitudinal slope of the street affects the operation of the internal combustion engine of the vehicle and as a result the pollutants mass in the atmospheric air from stream of the vehicles in general.

4. With increasing slope from 0 to 5% the emissions of NO<sub>2</sub> and CO can grow 3...15 times as many. The increase of emissions of hydrocarbons C<sub>x</sub>H<sub>y</sub> on slopes is due to the release of undeveloped fuel.

5. Influence on the main roadside territory is highly dependent on the slope of the road, where emissions could increase NO<sub>2</sub> 6...7 times as many.

6. The proposed "model of the dependence of mass emission from road transport on geometrical parameters of intersection of main roads at different levels, such as slope and radius of curves" when applying it for traffic interchange at the intersection of boulevard Druzhby Narodiv and Naddnipryanskoho shose in Pecherskuy rayon in Kyiv yielded results, such as the decline in the pollutants mass of NO<sub>2</sub>, CO and C<sub>12</sub>-C<sub>19</sub> into the atmospheric air from road transport through optimal longitudinal slope coefficients corresponding to 0,35, 0,41 and 0,35% respectively. This makes it possible to assert that only the optimization of longitudinal slope rates of elements of main road intersectional junction provides reducing pollutants emissions into the atmospheric air from vehicles. Even if the rate of reduction of mass emission is small not only when it comes to one main road intersectional junction, but also when it is a matter of the entire city road network, the effect will be much more considerable.

## REFERENCES

1. **Beshun O., 2014.** Dynamics of multicylinder diesel engines with power control disconnecting cylinders and cycles. Motrol: kom. Mot. Energ. Roln., OL PAN, Vol.16-3, 265-272. (in Russian).

2. **Chuba V., Golub G., 2013.** The environmental performance of the D-65N on biodiesel. Motrol: kom. Mot. Energ. Roln., OL PAN, Vol.15-4, 172-179. (in Russian).
3. **DBN 360-92., 1993.** Town planning. Planning and development of urban and rural settlements. Kyiv, Minbuda-rhitektury of Ukraine, 64. (in Ukrainian).
4. **DBN V.2.3-5-2001., 2001.** Streets and roads settlements. Kyiv, State Building of Ukraine, 50. (in Ukrainian).
5. **DSP 173-96., 1994.** State sanitary rules of planning and building settlements. Kyiv, Ministry of Health of Ukraine, 84. (in Ukrainian).
6. **Gerasymchuk Y., 2014.** Optimizing the composition of the mixture in the regulation of the power of the petrol engine by shutdown working cycles. Motrol: kom. Mot. Energ. Roln., OL PAN, Vol.16-3, 152-158. (in Russian).
7. **Gutarevich Yu, Klympush O., 1981.** Reducing toxic emissions during operation of the vehicle. Kiev, Tehnika, 88. (in Russian).
8. **Kanilo P., Bay I., Rovenskiy O., 2000.** Car and the environment. Kharkiv, A flag, 304.
9. **Kositsina E., Forikova T., 1989.** The environmental impact of vehicles on the danger of the urban environment. Volgograd, VolgPI, 12-16. (in Russian).
10. **Kryvomaz T., Voloshkina O., 2014.** The Risk Assessment of Threats from Biological Objects in Environmental Safety. Motrol: kom. Mot. Energ. Roln., OL PAN, Vol.16-8, 137-144.
11. **Lantsberg J., 1983.** City squares, streets and roads. Moscow, Stroyizdat, 150. (in Russian).
12. **Maechyk V., Zakharchu V., Zakharchuk O., 2013.** Determination of rational parameters of management of transmission and gas engine wheel tractor in the transport process. Motrol: kom. Mot. Energ. Roln., OL PAN, Vol.14-4, 309-313. (in Russian).
13. **Maslov N., 2002.** Town planning ecology. Moscow, Higher School, 284. (in Russian).
14. **Methodical instructions on the calculation of emissions of hazardous substances by motor transport., 1985.** Moscow, Gidrometeoizdat, 36. (in Russian).
15. **Methodical instructions on the calculation of emissions of hazardous substances by motor transport., 1993.** Moscow, Gidrometeoizdat, 44. (in Russian).
16. **Podznoev G. Abdulgazis U., Zharik T., 2014.** Thermodynamic possibility of increasing the efficiency of the internal combustion engine. Motrol: kom. Mot. Energ. Roln., OL PAN, Vol.16-1, 95-100. (in Russian).
17. **OND-86., 1987.** The methodology for calculating the concentration in the air of harmful substances in industrial emissions. Leningrad, Gidrometeoizdat, 92. (in Russian).
18. **Osyetrin M., 1997.** Urban traffic facilities. Textbook for students. Kyiv, ISBN, 196. (in Russian).
19. **Solukha B., Fuchs G., 2004.** Urban ecology. Textbook. Kyiv, KNUCA, 338. (in Ukrainian).
20. **Technique of determining the mass emissions of pollutants from motor vehicles in atmospheric air, 1993.** Moscow, Ministry of Transport of the Russian Federation, 68. (in Russian).
21. **Vetrova N., 2013.** Ecological audit and ecological monitoring in environmental safety of a region. Motrol: kom. Mot. Energ. Roln., OL PAN, Vol.14-1, 80-85.
22. **Voloshkina O., Bereznitska J., 2014.** Development of Ukraine Territory Flood-ing Processes; Its Parameters and the In-fluence on the Environmental Safety Lev-el. Motrol: kom. Mot. Energ. Roln., OL PAN, Vol.16-8.

ВЛИЯНИЕ ПРОДОЛЬНОГО УКЛОНА  
ПРОЕЗЖЕЙ ЧАСТИ МАГИСТРАЛИ  
НА МАССУ ВЫБРОСОВ ОТ АВТО-  
МОБИЛЬНОГО ТРАНСПОРТА  
В АТМОСФЕРЕ

**Аннотация.** Рассмотрены вопросы влияния продольного уклона улицы, эстакады и съездов узла пересечения магистрали в разных уровнях на режим работы двигателя внутреннего сгорания и как следствие массы выбросов загрязняющих веществ в атмосферный воздух. Отмечено, что продольный уклон улицы влияет на режим работы двигателя внутреннего сгорания автомобиля и как следствие на массу выбросов загрязняющих веществ в атмосферный воздух от автомобильного потока в целом.

**Ключевые слова:** продольный уклон, массы выбросов, атмосферный воздух.





## Intersectional junctions of the main roads in city SRN system (on the basis of Kyiv SRN system)

Igor Solukha

Kyiv National University of Construction and Architecture  
Povitroflotskyi prosp., 31, Kyiv, Ukraine, 03680, e-mail: igorsoluha@ukr.net

**Summary. Relevance:** Issues of the concept of the street and road network (SRN), the role and place of transport planning junction in city SRN and the intersectional junctions of main roads at different levels in the SRN system are raised. The tasks of research: **consider** the concepts of SRN, road junction and main roads intersection at different levels. **The technique of research:** the typological technique of theoretical analysis for determining the role and the place of junction in the SRN system is implied. **The results of research:** It was established that intersections are built at different levels for the improvement of the traffic streams of vehicles and reducing the number of conflict points at the main roads junctions. **Conclusions:** intersectional junctions of the main roads in system of city street and road network is a source of transport and ecological problems of the city.

**Key words:** SRN, transport-planning junction, main road intersectional junctions at different levels.

### GLOSSARY

*Street and road network (SRN)* – designed network of streets for vehicle traffic and pedestrians, public roads, internally quarterly and other driveways, sidewalks, pedestrian and cycle paths, embankments, squares, street parking with engineer-

ing and subsidiary facilities, technical means of traffic organization.

*Road junction* – complex transportation facilities at intersection or furcating points of urban road transport, which together fulfill operations on transit, distant and local transportation of passengers and cargo. At the crossing points or junctions of two or more types of urban transport focal points of the transport system are formed, where the interaction of these modes of transport is made.

### INTRODUCTION

The special feature of big cities is a high mobility of the population, which is achieved through dynamic transport. At the same time the sections load of street and road network of transport depends on the local scale of individual districts as well, as their functional profile and planning structure. Main roads and local streets can be singled out as part of Ukrainian cities SRN [1, 9-11].

Streets and roads categories are set according to the classification: main roads, where the main stream public transport moves - citywide and district; local streets - the street, residential roads, indus-

trial and storehouse and public utilities zone roads, driveways.

The degree of the road network development is determined by its length and density, which is measured by the ratio of the roads length to the area of the urban area (km / km<sup>2</sup>). This indicator shows the degree of the street and road network development in the whole city, and in separate districts.

While examining Kyiv SRN system it was ascertained that streets and road system consists of main streets of citywide significance – 8%, the streets of district importance – 14%, and the streets of local significance, representing about 78% of all roads combinations. The total length of Kyiv street network is more than 1.6 thousand kilometers. This indicates that the low development of main streets of citywide and district importance [2-4, 14].

Main roads intersection is the most critical element in the formation of traffic jams, because it is a major factor in reducing speed and safety at SRN. Bandwidth of squares and crossroads that form road and transportation junctions on main roads of the city eventually turns deflated. A need in the search for a solution appears. Solution which ensures the correspondence of the bandwidth to characteristics of streams that intersect at the junction. At the main roads' junctions the intersections are built at different levels for the improvement of the traffic streams and reducing the number of conflict points. Usually there are no vehicle streams intersections at one level, only confluence maneuvers are available, furcating and weaving of streams. Junctions at the one or different levels should be designed in accordance with the categories of streets and roads that are intersected or adjoined, taking into account prospective intensity of transport and pedestrian traffic [8, 12, 17, 20].

## BASIC MATERIALS SUMMARY

The rapid process of automobilization is including more and more cities every year, automobile fleet is growing, which is in-

creasing the burden on the road network of the city. The growth of automobilization and volume of traffic results in the increasing in traffic intensity, which favours the occurrence of transport problems in a city with historical buildings. Particularly problems are shown at the focal points of the street and road network – junctions, where increased transport delays rise, jams appear. All these factors provoke decrease in speed connections, unjustified fuel overspending, worsening of environmental conditions. The problem becomes more complex in city central areas, and in areas of old buildings that are typical of narrow roadway, short quarterly sections between intersections and considerable intensity of pedestrian traffic.

Transportation planning system consists of a number of interrelated elements such as street (citywide main roads of continuous motion, citywide main roads of controlled movement, roads of regional importance, residential streets and roads in the industrial and storehouse and public utilities zone roads, driveways), traffic junctions (unregulated traffic, forcibly controlled traffic, self-regulating traffic (circular motion) and the traffic at different levels), bridges and tunnels.

The most important indicator of main road section as transportation planning system is its capacity, which is determined by engineering and planning structure of intersection, road transport passing organization, planning scheme and its geometric parameters, accepted traffic organisational chart.

Choice problem of engineering and planning decision on intersections junction of the main roads is reflected in scientific publications, models of SRN, but remains extremely difficult because of the specifics of each particular group of urban intersectional junctions formed historically and a great amount of contradictory factors that should be considered while seeking optimal solution of the problem. Despite the engineered methods that are aimed at increasing traffic and degree of intersections' loading, increase of the capacity of SRN and traffic safety, the multicriterion problem can't be solved by any of

the known methods because of the significant weight of individual parameters for each junction. Capacity increase of urban SRN in most techniques can be achieved either through construction and reconstruction measures, or through the introduction of a number of organizational measures such as the distribution of traffic, the introduction of intelligent traffic light control that acts on the intersectional junctions of main roads and so on. It is known that the use of architectural and planning measures requires, in addition to significant investments, quite a considerable period of time to complete, so their implementation is part of general reconstruction of SRN. Arrangements are also limited both the hardware and algorithmic aspects, but for some time they allow the serious problem of junction overload in the SRN to be reduced due to less costs.

Despite the low advancement of main streets system of citywide and district significance, Kyiv SRN has more than 100

junctions which accumulates the stream of road transport, which in turn leads to environmental worsening in surrounding areas of these main road intersections. Therefore, the study of the junction in the SRN system is the most productive because of reducing environmental pollution of the city on the whole. Traffic streams are concentrated at the junctions, traffic conditions change, and so the ecological load on the territory adjacent to the junction increases greatly [5-7, 9].

Having regard to the fact that functional public transportation and streets are unified engineering and technical system, intersections of city streets and roads, where traffic and pedestrians' streams are mainly concentrated, should be considered as part of this system in the form of road and transportation junctions.

The type of junction is selected depending on its functional features, characteristics of communication lines in the junction, the

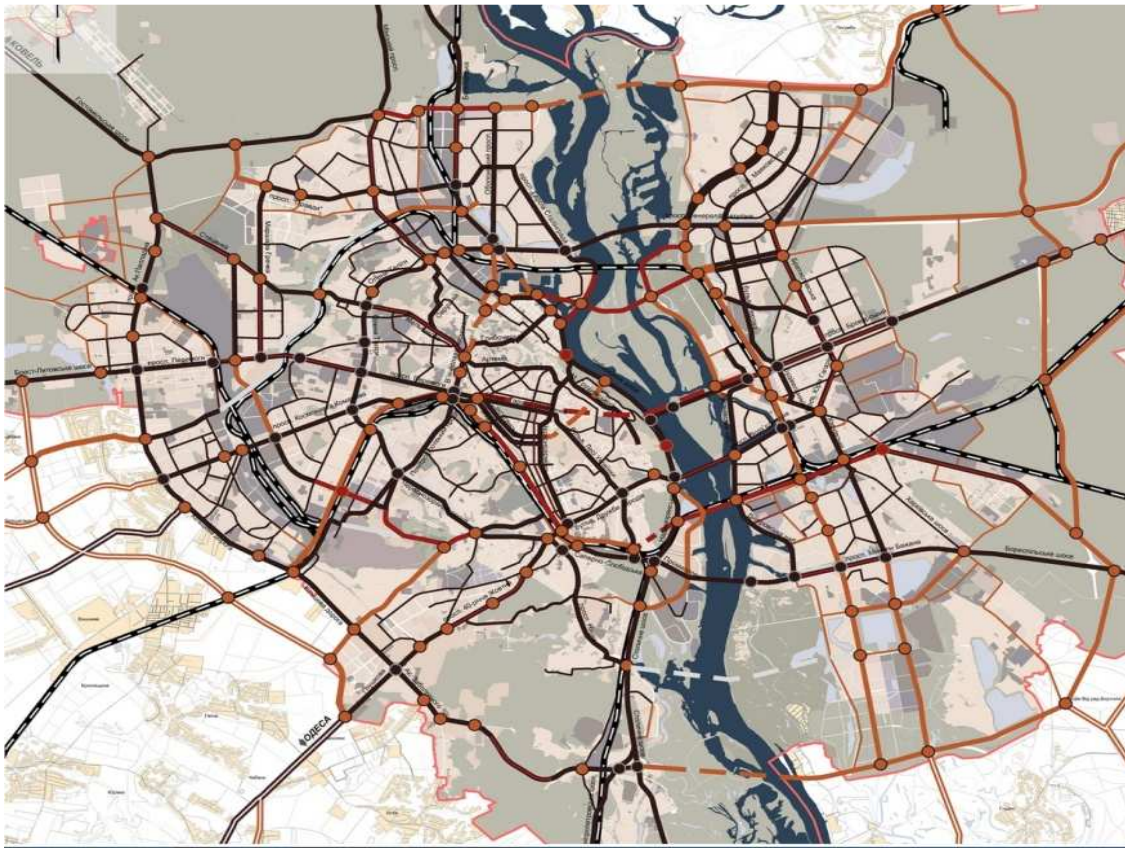

**Fig. 1.** Kyiv street and road network

availability of free territory for the construction of the intersection, the size and composition of the traffic streams due to driving directions and presence of pedestrians.

Creating conditions that ensure the pedestrians and public transport safety with traffic organization at the intersection of streets and roads (induced delays would be reduced as much as possible due to such organization) represents a multifaceted problem that has no clear solution. Its solution is achieved by the implementation of complex of planning, engineering, technical, organizational and regulatory measures.

Planning decisions include: planning of the street and road network, tracing of streets and roads, their designing in plans and profiles, designing of intersections of streets and roads at the same and different levels, traffic segregation due to driving directions, segregation of pedestrian and traffic streams among themselves and so on.

Engineering and technical measures include: appropriate decision on road surface, drainage system, lighting, artificial structures that provide comfort and traffic safety.

Organizational measures should include: efficient operation of all transport modes, high operational characteristic of street and road network of the city.

The implementation of one or another principle of the traffic organization of transport and pedestrians streams at the junction coupled with planning conditions are specialist's objective when searching for the optimal solution of the given junction.

Street and road network of the city is examined not as separate junctions, but as whole junction system of urban transport intersections. By the example of Kyiv city street road network system with a graphical display of concentration of vehicle stream on the main road network and accumulation at the intersectional junctions of main roads is shown [18, 19].

In Kiev the most loaded road intersectional junctions of urban main roads are at the intersections of the main radial directions and a large ring road. Other junctions are formed at the crossroads of citywide main roads and streets of district significance (Fig. 1) [9, 16].

One might say that the formation of intersection junctions of main roads is natural process of city development. Analyzing and projecting them, we are able to operate with those city elements that are most significant for its development and above all should become the object of the study of urban development and ecological perspective [13, 15].

Besides the obvious advantages for traffic, intersectional junctions of city main roads at different levels allow to reduce the impact on air pollution level 4...10 times. In the beginning of 21<sup>st</sup> century design solutions for optimizing the intersections of main roads are specified largely due to sanitary requirements. At low aeration properties of the territory comparison criteria of variants of engineering and designing of intersectional solutions based on estimates of conventional vehicles emissions are used. Pollution of main roadside territory from intersections of main roads at different levels is due to the positive (change of speed limits, the elimination of downtime, lifting one of the main streams on the pier) and negative (over mileage of left-handed streams; slope due to the difference of heights 6...7 m between directions) factors. Intersections of city main roads at different levels are divided into several main types according to traffic organisation of left-handed streams: cloverleaf; incomplete cloverleaf; trumpet; roundabout; loopback; combined. Their environmental effectiveness depends on driving conditions, but "cloverleaf" with the overpass is considered as the best (Fig. 2).

INTERSECTIONAL JUNCTIONS OF THE MAIN ROADS IN CITY SRN SYSTEM  
(ON THE BASIS OF KYIV SRN SYSTEM)

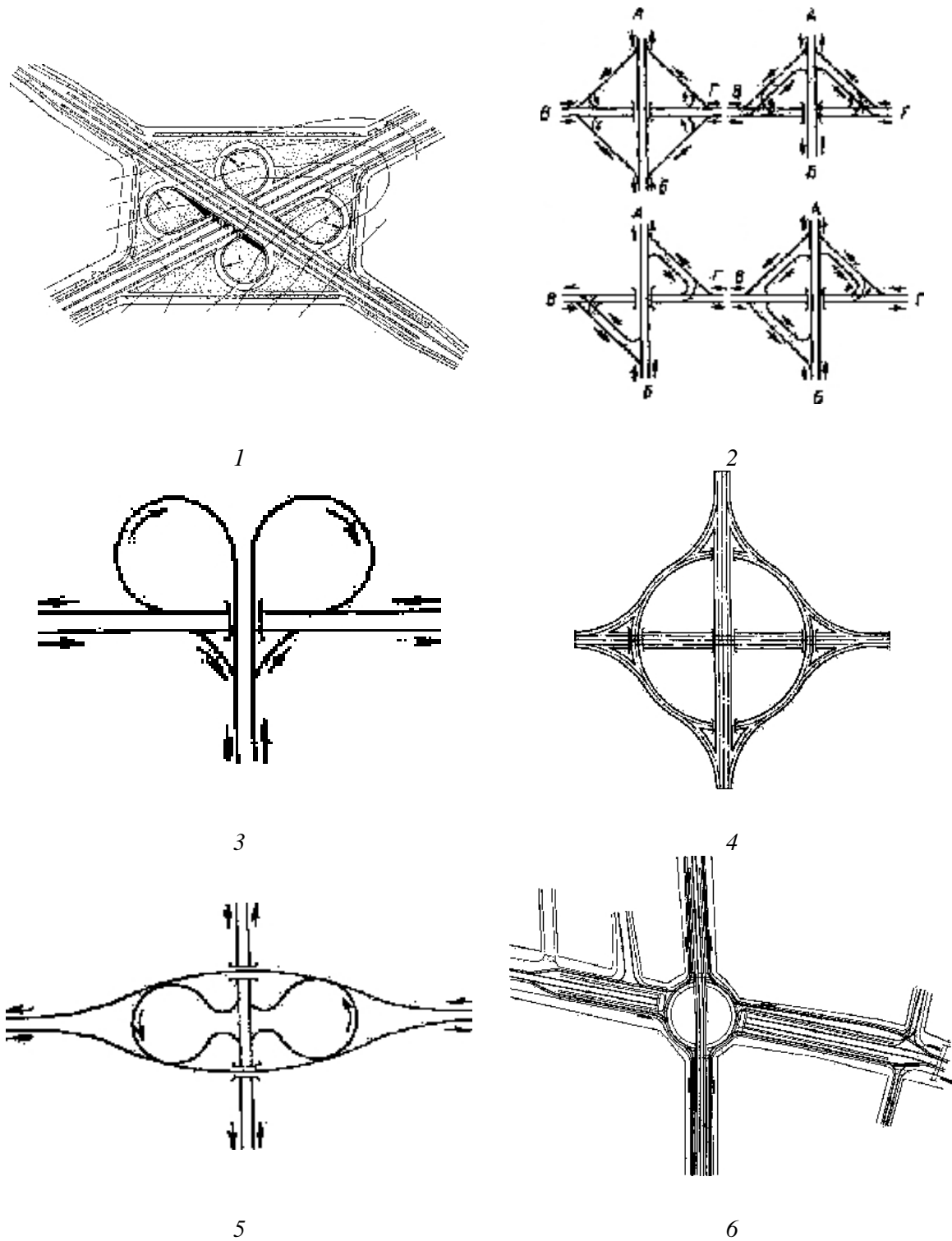

**Fig. 2.** Intersection types of city main roads at different levels:

1 – “cloverleaf”, 2 – “incomplete cloverleaf”, 3 – “trumpet”, 4 – “roundabout”, 5 – “loopback”,  
6 – “combined”

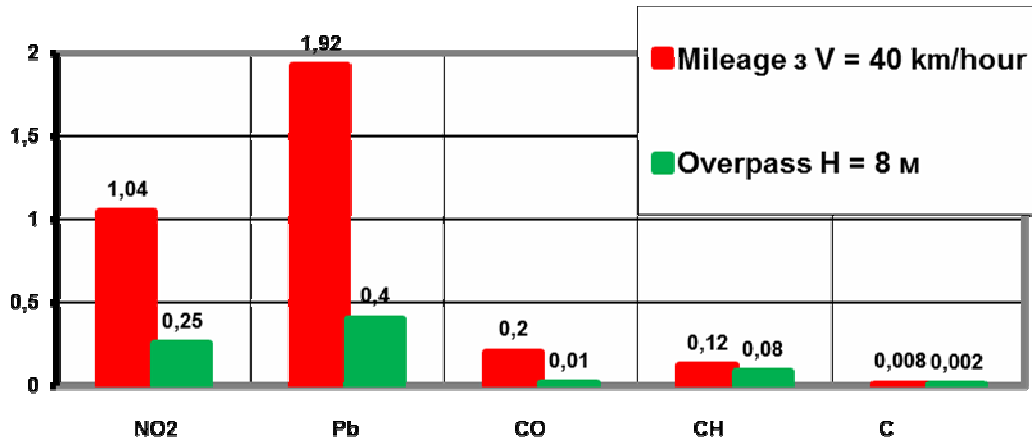

**Fig. 3.** The impact of the construction of the overpass on reducing the level of maximum one-time pollution of the surface atmospheric layer at a distance of 30 meters from the edge of the road at 4000 natural units / hour of traffic intensity

During the reconstruction of transport junction decisions that involve the need in repeat reconstruction in a given time are often made. Due to the positive impact on the living conditions of the population the value of intersections of city main roads at different levels is not so great.

Rationally designed intersection of main roads at different levels ensures compliance with hygiene norms at traffic intensity to 10,000 natural units/hour. The traffic of transport stream on the intersectional overpass of the city main roads at different levels

## CONCLUSIONS

1. Main roads junctions as part of the city street and road network is a center of transportation problems in the city, formed as a result of increase in automobilization and road haulage volume, which in turn results in the increase in traffic intensity.

2. Transportation planning system consists of a number of interrelated elements such as streets, road junctions, bridges and tunnels.

3. Street and road network is seen as a system of individual driving and junctions of

is accompanied by decreasing in mass emissions by eliminating of maneuvers and their additional scattering when lifting the main stream above the ground (Fig. 3).

The intersection of main roads at different levels provides a significant reduction of mass emissions and concentrations of contaminants by eliminating maneuvers. It is possible, firstly, in proportion to reduction of mass emissions, and secondly, due to the additional dispersion of pollutants by driving the main stream at a certain height above the ground.

the city, and can be regarded as a separate junction in the city system of street and road network.

4. The maximum concentration of traffic at the junctions of street and road network of the city arouses the largest concentration of environmental pressure on adjacent territory of the junctions.

5. Main roads intersections are the most critical element in the formation of traffic jams. Intersections are built at different levels to improve the traffic streams of vehicles and reducing the number of conflict points at the intersection.

REFERENCES

1. **DBN 360-92., 1993.** Town planning. Planning and development of urban and rural settlements. Kyiv, Minbudarhitektury of Ukraine, 64. (in Ukrainian).
2. **DBN V.2.3-5-2001., 2001.** Streets and roads settlements. Kyiv, State Building of Ukraine, 50. (in Ukrainian).
3. **DBN B.1-2-95., 1995.** Composition, content, development, coordination and approval of integrated transport schemes for cities in Ukraine. Kyiv, Derzhkommistobuduvannya Ukraine, 33. (in Ukrainian).
4. **Govorun A., Skorchenko V., Hudoliy M., 1992.** Transport and environment. Kyiv, Urozhay, 144. (in Ukrainian).
5. **Kostin A., 1984.** Calculation of weighted emissions from transport stream. Chelyabinsk, Teza conference reports, 35-36. (in Russian).
6. **Kryvomaz T., Voloshkina O., 2014.** The Risk Assessment of Threats from Biological Objects in Environmental Safety. Motrol: kom. Mot. Energ. Roln., OL PAN, Vol.16-8, 137-144.
7. **Murovskaya A., Fedorkin S., 2014.** An integrated approach to the assessment of oil pollution of ecosystems coastal cities (for example, the city of Feodosia). Motrol: kom. Mot. Energ. Roln., OL PAN, Vol.16-5, 177-182. (in Russian).
8. **National Report on the State of Environment in Ukraine in 1999., 2000.** Kyiv, Minekoresursov, 184. (in Ukrainian).
9. **Osyetrin M., 1997.** Urban traffic facilities. Textbook for students. Kyiv, ISBN, 196. (in Russian).
10. **Osyetrin M., Cherednychenko P., 1987.** Some environmental aspects of the design of intersections and city roads in different levels. Chelyabinsk, Collection of City and Environment, 32. (in Russian).
11. **Osyetrin M., Stelmach O., 2000.** Features motorization cities of Ukraine (Kyiv for example). Kyiv, Urban Development and Territorial Planning, 176-185. (in Ukrainian).
12. **Polishchuk V., Lanovoi A., 2012.** Practical methods functioning efficiency estimation and the need for the development of the road network. Motrol: kom. Mot. Energ. Roln., OL PAN, Vol.14-3, 70-77. (in Russian).
13. **Sigal I., 1988.** Protection of the air basin from fuel combustion. Leningrad, Nedra, 312. (in Russian).
14. **Solukha B., Fuchs G., 2004.** Urban ecology. Textbook. Kyiv, KNUCA, 338. (in Ukrainian).
15. **Technique of for calculating emissions of pollutants by mobile sources., 2000.** Kyiv, State Statistics Committee, 107. (in Russian).
16. **Technique of for calculating the impact of a simplified road transport emissions on air pollution of cities of Ukraine., 1994.** Kyiv, UkrNDGMI, 18. (in Ukrainian).
17. **Velikanov L., 1976.** Auto transport and the Environment. Moscow, Energy and Transport № 6, 98-109. (in Russian).
18. **Vetrova N., 2013.** Ecological audit and ecological monitoring in environmental safety of a region. Motrol: kom. Mot. Energ. Roln., OL PAN, Vol.14-1, 80-85.
19. **Vladimirov A., Lyahin Yu, Matveev L., Orlov V., 1991.** Environmental protection. Leningrad, Gidrometeoizdat, 422.
20. **Voloshkina O., Bereznitska J., 2014.** Development of Ukraine Territory Flooding Processes; Its Parameters and the Influence on the Environmental Safety Level. Motrol: kom. Mot. Energ. Roln., OL PAN, Vol.16-8.

УЗЕЛ ПЕРЕСЕЧЕНИЯ МАГИСТРАЛЕЙ  
В СИСТЕМЕ ВДМ ГОРОДА  
(НА ПРИМЕРЕ ГОРОДА КИЕВА)

**Аннотация.** Рассмотрен вопрос понятия улично-дорожной сети, роли и места транспортно-планировочного узла на ВДС города и узла пересечения магистралей в разных уровнях в системе УДС. Отмечено, что улично-дорожная сеть рассматривается не только как система отдельных перегонов и узлов города, но может рассматриваться и как отдельный узел в системе улично-дорожной сети города.

**Ключевые слова:** УДС, транспортно-планировочное узел, пересечение магистралей в разных уровнях.





## Algorithmization tests development of spatial imagination

Viktoria Honta

Kyiv National University of Construction and Architecture  
Povitroflotskyy prosp., 31, Kyiv, Ukraine, 03680, e-mail: vika.pron@mail.ru

**Summary.** In the article it is looked at the method algorithmization of chosen tests for development of spatial imagination, proposed combined algorithm for test of spatial imagination, shown schematic use of auxiliary algorithm. Setting further set of measures.

**Key words:** spatial imagination, testing, algorithmization, linear algorithm, branching algorithm, auxiliary algorithm, cyclic algorithm.

### INTRODUCTION

The increasing number of subjects were closely linked to the computerization and programming that leads to change and transformation of educational system. These changes are associated with parts of the constant improvement of educational system that enables to raise the level of science and technology. One of the key components of science is the control and verification of knowledge. The most objective method of verification of knowledge and skills are tests. Previous article reviews basic criteria for tests of spatial imagination and their comparative analysis, through which were found potential unaccounted criteria of existing tests [6]. This article guides us to improve the search quality of tests for spatial imagination, this can be achieved through

algorithmization of tests structure listed in the previous article.

### PURPOSE OF WORK

The purpose of this article is to determine the algorithmic parts of the test of spatial imagination (TRPU), identification of problems of these tests. Combined TRPU algorithm development with subject to certain criteria.

### FORMULATION OF THE PROBLEM

Modern testing technology allow not only to evaluate testing results but also register all actions and time participant used for this effect, that is why tests of spatial imagination should be closely analyzed and improved. Systematic consideration of the problem of graphic technology allows us to explore and implement new methods of spatial imagination [9, 15].

### MAIN PART

Algorithms depending on the purpose of initial conditions, problem and ways of resolving, determination and actions are divided into: probabilistic, heuristic, linear, branched, cyclic and support.

After detailed analysis of tests of spatial imagination and system rules for discrete process of each of the algorithms, it can be concluded that the use algorithmization structure of tests of spatial imagination are con-

sidered only in two types of algorithms, all others are not involved (Fig. 1).

Algorithms of simple (linear) processes do not contain any stages that has more than one heir, i.e. algorithms implemented a simple

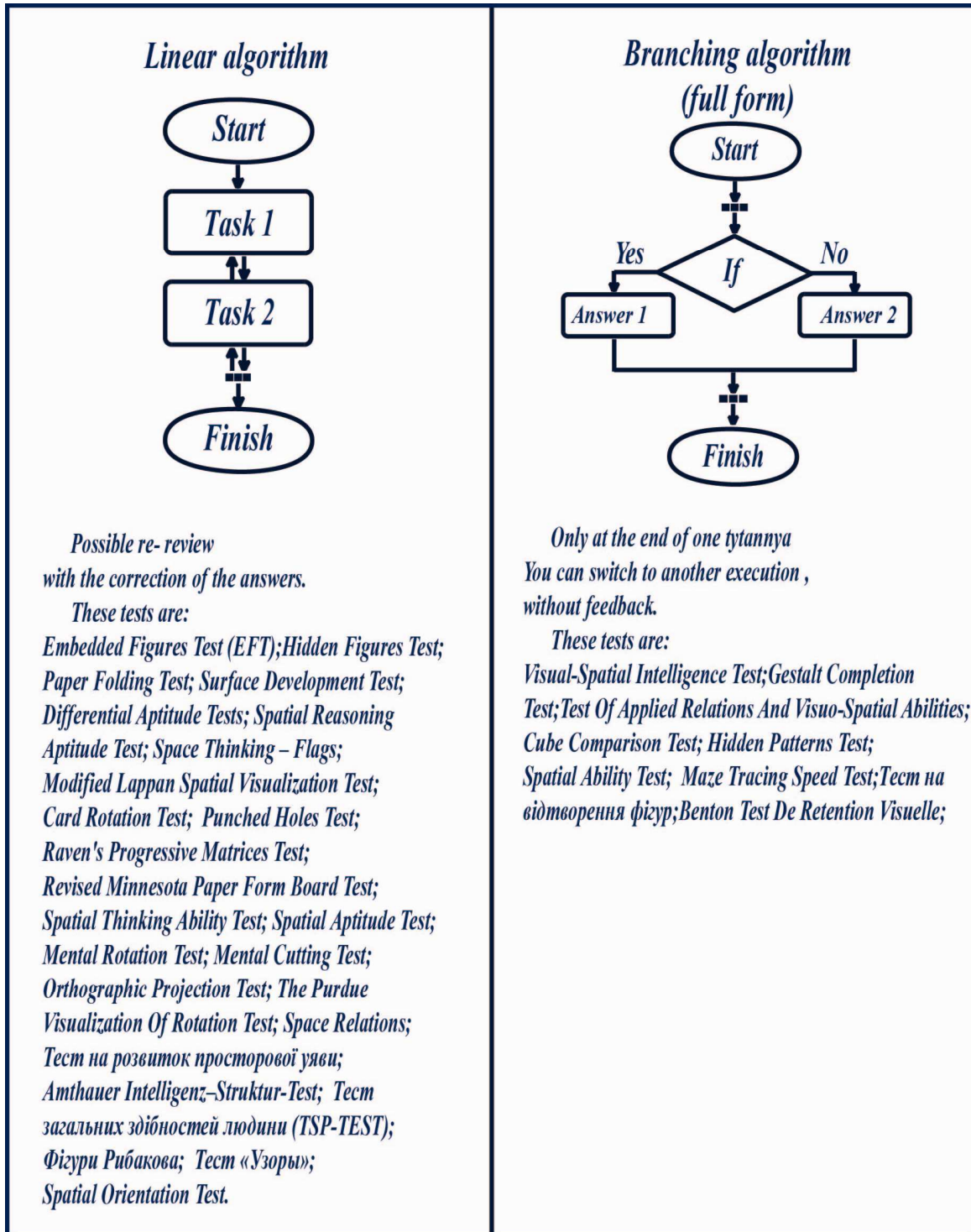

**Fig. 1.** Definition algorithmization structure of TRPU

sequence of operations. An example of a linear algorithm of test of spatial imagination is test on paper with ability to return to previous questions and redo them (in some tests corrected answers are counted for the mistake).

Branching algorithm – the second of the typical kinds of algorithms. Branching begins with certain conditions, if the condition is satisfied, the action or set of actions takes place – if not different. Computer tests can be included to tests with algorithm of branching, where it is impossible to return to the previous questions without answers given (not necessarily true) on the previous one. Examples are paper tests in which the rules does not allow transitions between questions [2, 3, 13].

As a result of the mechanism consideration of algorithms of tests for spatial imagination formation another test algorithm may be offered, such as combined.

Combined algorithm of tests of spatial imagination may contain several different functions and supporting algorithms for better effectiveness of test. Thus, we can broaden the base of reach and qualitative level of testing. Implementation of combined algorithm of TRPU will allow to estimate not only the testing participant's level, but also his knowledge of the structure and potential in learning.

Based on previous studies of algorithmization TRPU basic schemes of algorithms (linear algorithm, branching algorithm) were revealed. The result of this study allows to develop a model of combined algorithm by using of different types of software algorithmic systems, depending on the purpose and objectives of the test [8, 14, 22].

At the stage of requirements analysis for testing process the purpose and goal of development was defined. The purpose of combined TRPU algorithm development is to create a quality product evaluation of spatial imagination of students. The main goal in creating combined TRPU algorithm is successful validation of the product.

Therefore, it was decided to form a combined system of linear, cyclic, auxiliary algo-

rithms and branching algorithm. The system will help improve the efficiency of testing.

For correct construction of combined TRPU model it is necessary to consider the priority of algorithms in terms of complexity. In the above tests, the sequence of questions is increasing or linear (all tasks of one form). An essential criteria is mutually beneficial position of blocks in algorithm. Forms a sequence of test tasks of spatial imagination needs improvement and logical structuring [4, 7].

To create final combined TRPU algorithm it is needed to determine what form of tests and in what sequence will be used in the known tests. This knowledge base will allow to carefully prepare a platform for the creation of a combined test algorithm of spatial imagination [12, 21].

During test creation open and closed forms of tests are used, that are recommended for use by SMC MES of Ukraine [16].

Tests with open form allow to fill free answer or complement the answer. The tasks of the open form are: tasks with gaps, tasks with addition, tasks with short answer, and tasks with expanded answer [17]. The task of open form evaluates the knowledge and skills in calculation, knowledge of facts, rules, terms, etc. Tests of open form with properties and characteristic belonging to tasks of branching algorithm.

The tasks of the closed form, with choice answers include: the task with one or more correct answers. These tasks belong to linear algorithm, transition to the previous task is possible between tasks this algorithm.

Also, the closed form tasks include tasks on restoring of compliance, tasks to establish the correct chronological or logical sequence – these are tasks of cyclic algorithm block.

In standardized academic performance tests most commonly used form is closed tasks, these tasks diagnose understanding and application of knowledge, sequence of

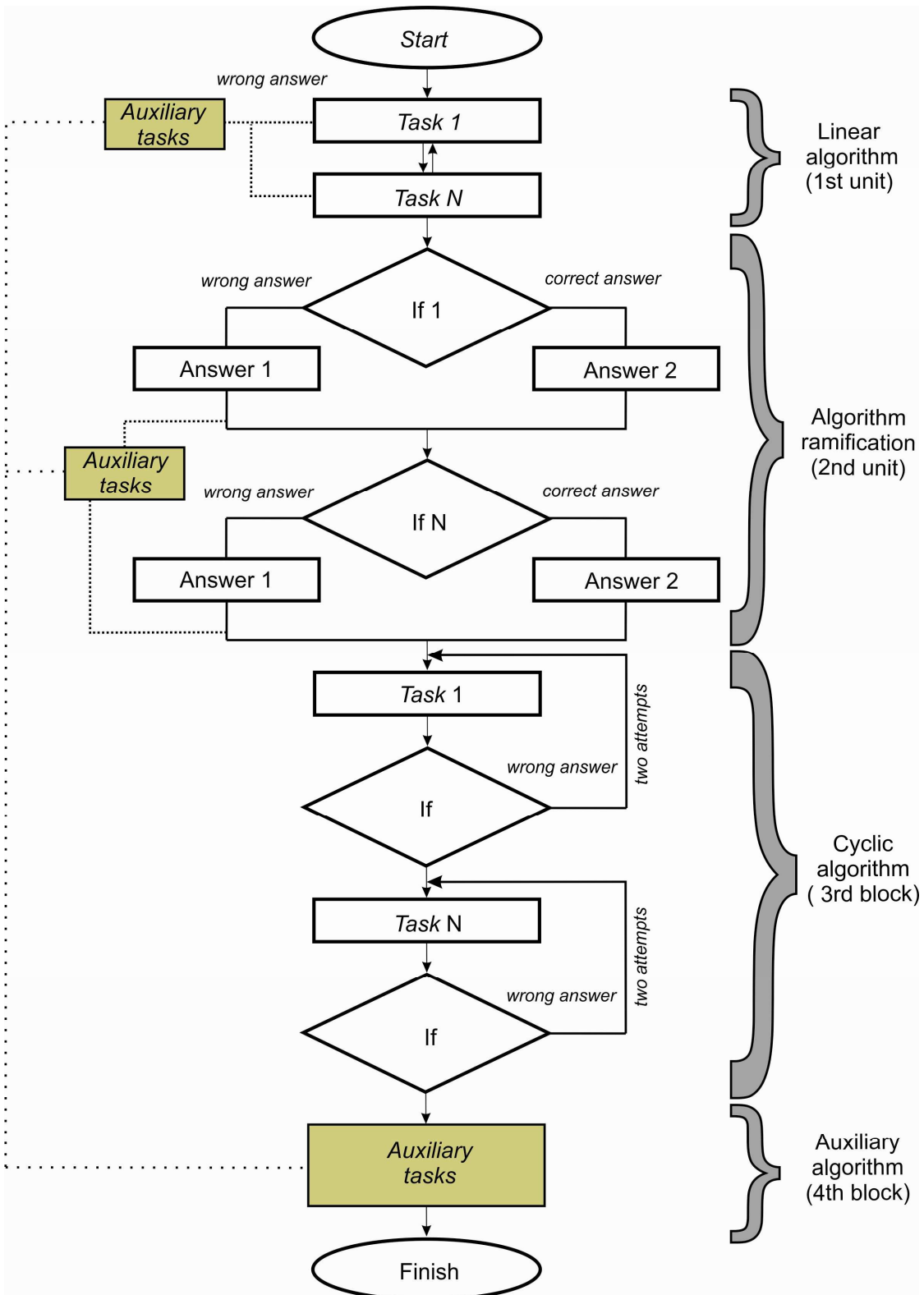

**Fig. 2.** Block diagram of combined TRPU algorithm

actions and operations. In tests of spatial imagination primarily tasks of the closed form are used.

For effectively verification of knowledge and skills, it is recommended to add auxiliary algorithm for combined algorithm of spatial imagination tests. All blocks of fixed algorithms (linear, branching, cyclic), include auxiliary tasks which are to be placed in the fourth block of combined algorithm [11, 18].

This block is generated from similar questions that student did not give the correct answer. This optional feature of this algorithm is to re-examine the level of knowledge of the topics specified (Fig. 2).

Creating step by step productive flowchart of combined algorithm, next necessary step to develop the full form of the test is to apply additional elements to the test circuit such as time, color, work with memory and more [20].

In further work, in order to minimize the number of errors in the creation and use of combined TRPU it is needed to create a set of measures:

- Formulation of the problem of tests and practical tasks development;
- Design of tests and practical tasks;
- Verification of tests for compliance with the task;
- Implementation of testing process;
- Study and analysis of test results.

## CONCLUSION

Development of tests for spatial imagination makes a substantial contribution to the process of integration of educational courses for technical, architectural and artistic disciplines [5, 19, 10]. The presence combined algorithmization tests of spatial imagination will significantly increase the effectiveness of modern graphics technology.

## REFERENCES

1. **Bajaj C., Bernardini F., Xu Xu G., 1995.** Automatic reconstruction of surfaces and

scalar fields from 3D scans. Los Angeles, In SIGGRAPH, 109-118.

2. **Baranova E., Simonova I., 2004.** Development of information-technological competence of students in the system of Pedagogical Education. St. Peterburg, Herzen № 9, 158-168. (in Russian).

3. **Bulgatch R., Kurbatova N., Bronnikova I., Petrova I., 2014.** Architectural geometry. From model to virtual space. Novosibirsk, Engineering, from theory to practice, 121-126. (in Russian).

4. **Bonola R., 1955.** Non-Euclidean Geometry: A Critical and Historical Study of its Development. New York, 259.

5. **Demkin V., Mozhayeva G., 2009.** Organization of educational process on the basis of distance learning technologies. Tomsk, Training Toolkit, 135.

6. **Gawdzik M., 2006.** Transformation depreciated postindustrial space genius loci a source of new structures functional and spatial. Motrol: kom. Mot. Energ. Roln., OL PAN, 127-138. (in Polish).

7. **Hilbert D., 1899.** The foundations of geometry. Teubner, 3-92.

8. **Hilbert D., Cohn-Vossen S., 1965.** Geometry and the Imagination. New York, Chelsea, 272-275.

9. **Lihttsinder B. Ivanov L., 2006.** Quality control Knowledge-based probabilistic assessment criteria. Information technologies, Vol.2, 73-78. (in Russian).

10. **Malykhin A., 2006.** Test control and improve the quality of education in higher educational school, Kyiv, 14-16 (in Ukraine).

11. **Mayorov A., 2001.** Theory and practice of creating tests for the system of education. Moscow, Intelligence Center, 296. (in Russian).

12. **Pasch M., 1882.** Lectures on modern geometry. Leipzig, Teubner, 20-39.

13. **Pronevich V., 2015.** Comparative analysis of test criteria for the development of spatial imagination. Modern problems of geometric modeling. Proceedings of XVII International Scientific Conference Proceedings. Melitopol, 89-93. (in Ukraine).

14. **Riemann B., 1854.** On the hypotheses which lie at the geometry underlying. Society of sciences in gottiden, 133-152.

15. **Rosenfeld B., 1988.** A History of Non Euclidean Geometry, Evolution of the Concept of a Geometric Space. New York, 241-252.

16. **Rumyantsev I., 2004.** Applied theory of algorithms. Fundamentals of computer science content, 456. (in Russian).
17. **Safrankova J., 2006.** Sociological and psychological Aspects of architecture and urban space. Motrol: kom. Mot. Energ. Roln., OL PAN, 15-22. (in Polish).
18. **Sergienko V., Kuhar L., 2011.** Guidelines for the assembly of tests, 41. (in Ukraine).
19. **Sutkowska E., 2006.** The modern shape and importance of urban green as green public space in the city structure – a space for creation. Motrol: kom. Mot. Energ. Roln., OL PAN, 184-192. (in Polish).
20. **Thomas H. Charles E. Leiserson Ronald L., 2012.** Rivest Clifford Stein algorithms, construction and analysis, 1296.
21. **Buynytska A., 2012.** IT and technical training. Kyiv, 240. (in Ukraine).
22. **Waldo G., 2004.** Carl Friedrich Gauss, Titan of Science, New York, Mathematical Association of America, 230.

#### АЛГОРИТМИЗАЦИЯ ТЕСТОВ РАЗВИТИЯ ПРОСТРАНСТВЕННОГО ВООБРАЖЕНИЯ

**Аннотация.** Рассмотрен метод алгоритмизации выбранных тестов развития пространственного воображения, предложен комбинированный алгоритм теста развития пространственного воображения с учетом основных критериев создания тестов, показано схематическое использование вспомогательного алгоритма. Определение дальнейшего комплекса работ по разработке комбинированного алгоритма теста развития пространственного воображения.

**Ключевые слова:** пространственное воображение, тестирование, алгоритмизация тестов, линейный, вспомогательный, циклический алгоритмы, алгоритм ветвления.

## The effects of mirror reflection from flat and curved translucent structures

Valentina Karpenko

Kyiv National University of Construction and Architecture  
Povitroflotskyy prosp., 31, Kyiv, Ukraine, 03680, e-mail: vallav1988@gmail.com

**Summary.** The article gives examples of flat and curved translucent, mirror walling. There are presented variations of their formation by comparing with geometric transformations of form. Combinatorial technique is applied.

**Key words:** Mirror effects, geometric transformation, mapping, glass, facade, translucent walling.

### INTRODUCTION

Project design system involves form manipulating as an important element in the initial stage of formation of integral object. Architect, guided by specific conditions and restrictions, enters a new constructive form and gives it tectonics that generally determines development projected [2]. General classification of translucent enclosures includes a large number of items from windows to special facilities. In this study, attention is given to facade systems with different types of glazing curved walling [9].

### PURPOSE OF WORK

Determine the variance of comparison of simple geometric forms by transformation for finding opportunities and formatting their management tectonics. One of feature of light-reflecting structures is their feature,

leading to a multitude of options for creating objects with interesting mirror effects [6].

### THE RESEARCH RESULTS

Buildings of glass do not lose current market position. The first "Glass House" was built in 1949 by architect F. Janson in New-Keynen (USA). Houses function was to be aquarium because it does not protect the internal content of external factors. In a further effort to reduce the intensity of light and transparency began to use colored, frosted, mirror, polaroid glass (with one-sided visibility) [10].

There are global practices buildings with mirrored facades tectonics are fully fits into any environment through its reflecting properties. The primary function of such projects is the viewer's interest in exotic arrangement of the facade. For example "Mirror House" Peter Pichler is located near Bolzano, Italy [14]. Mirror glass, on the west facade of the building reflects the panorama of nature, making house barely noticeable (Fig.1, a). Laminated glass is covered and protected from UV radiation [8].

Another example of interesting and unusual architectural projects is one of the hotel rooms in Sweden [15]. The hotel consists of four rooms located on one of the trees where one of rooms is "Mirror Cube» ("The Mirror

cube") with dimensions 4×4×4 m (Fig.1, *b*). Visually little cube is visible as reflected in the mirrored walls surrounding. Windows made by solid monolith of mirror glass, and only in the night-time, they become noticeable from the light source located inside the cube.

a functional space for various cultural events. Through the use of the pavilion coating with reflecting properties, it does not appear facades but the mirrored space dynamics [3].

For the purpose and function of glass facade systems distinguish such key [9]:



*a*



*b*

**Fig. 1.** Global practices buildings with mirrored facades:  
*a* – "Mirse" by Peter Pichler; *b* – "The Mirrorcube", the hotel room

Small architectural forms with a mirror basis are also in high demand. Such example is Normans Foster mirrored roof. Pavilion area of 1000 sq. m consists of rectangular segments 22×46 m, which are supported by eight thin columns. The basic idea is to create

- General-purpose,
- Shockproof,
- Sun protection,
- Energy Saving,
- Freeze proof,
- Noise proof.



THE EFFECTS OF MIRROR REFLECTION FROM FLAT  
AND CURVED TRANSLUCENT STRUCTURES

**Table 1.** Types of surface objects

Straight

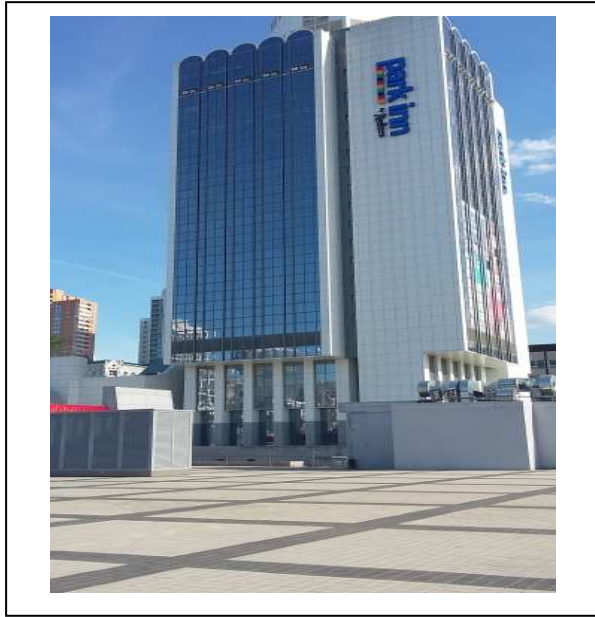

Convex

Concave

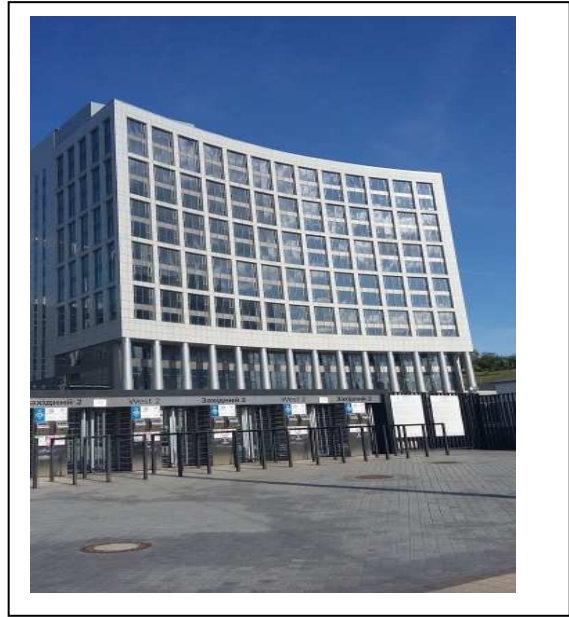

Fold system



Curvilinear









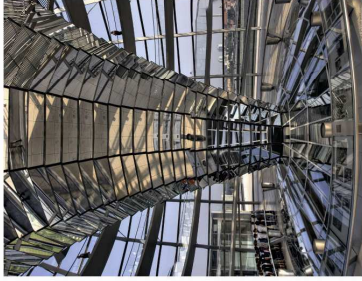



**Table 2.** Variants of transformation form

<p>The types of converting</p> <p>The types of shape</p>	<p>Symmetry</p> 	<p>Turning</p> 	<p>Transfer</p> 	<p>The mirror-turning</p> 
<p>1</p>	<p>2</p>	<p>3</p>	<p>4</p>	<p>5</p>
<p>1. Paralelepiped</p>				
<p>2. Cylinder</p>				



THE EFFECTS OF MIRROR REFLECTION FROM FLAT  
AND CURVED TRANSLUCENT STRUCTURES

**Table 2 (Continuation).** Variants of transformation form

1	3. Sphere	2		3		4		5		4. Pyramid					5. Cone				
---	-----------	---	-------------------------------------------------------------------------------------	---	-------------------------------------------------------------------------------------	---	-----------------------------------------------------------------------------------	---	-----------------------------------------------------------------------------------	------------	-------------------------------------------------------------------------------------	-------------------------------------------------------------------------------------	-----------------------------------------------------------------------------------	-----------------------------------------------------------------------------------	---------	---------------------------------------------------------------------------------------	---------------------------------------------------------------------------------------	-------------------------------------------------------------------------------------	-------------------------------------------------------------------------------------

The shape: flat and curved. Variants of this division are presented in the example of Kyiv in the Table 1.

These five types of surfaces are translucent structures with reflective properties that create mirror effects.

The first type is outline mirror on the facade of where no material deviations affect the environment. A large area of glazing is divided into segments to provide rigidity design, distortion display factor is small.

The second type is a concave curve that becomes concave mirror effect, where the rays falling, by the light reflected law, form the focus. In practice, there are negative consequences of scorched grass from sunlight focused at some point.

The third type is convex front system opposite scatters sunlight by reflecting the sun's rays in a convex mirror, and the façade segments the environment.

The fourth type is folded structures included the same overall mirror canvases, different rotation is only reflected directions of space, due to folded façade [4].

The fifth type is parametric architecture, design formed by splitting planes of the same type elements. This form is curvilinear light reflection, which leads to interesting effects [13].

In Table 2 there are conducted a comparison of simple shapes that create objects with geometric transformations. This classification allows more broadly understand the variability in the forms through a combination of architecture and geometric properties developing morphogenesis [16].

Geometric transformation applied to the overall glass facades add showiness and uniformity and form new-combined effects [17].

Presented in the analysis facilities are functioning as character exhibits due to their originality in the perception of spatial and visual qualities. [1] By competing in the championship of the world market eccentric architectural forms and objects set a trend dominance of simple geometric shapes based on complex tectonics [12].

Structures made in such extraordinary style shaping objects are usually not as prac-

tical for general image of the city or metropolis as unique fantasy of architect. Buildings in the form of spheres or inverted cone are the manifestation relevance as an institution venues, entertainment centers, libraries, etc. Glass structures add effects designed display environment, providing insolation and is easily perceived visually than such structures in reinforced concrete design.

## CONCLUSIONS

1. Modern trends mirror glass architecture of space to earn more than the creation of architectural objects. [cubic city] Depending on the power of the variation is transparent glass mirror effect it is the main organization of space and reflected the environment.

2. The accent is filling the internal space into a dark time, accompanied by point sources of light, or media facades that transform plane as the category of information space.

3. In the organization of the city are set clear limits of saturation of objects and buildings. Trends of glass structures apply to the construction of many facilities, including the restoration and reconstruction of historical parts of the city, destroying the system, making contradictory elements in the image.

## REFERENCES

1. **Bar G.F., 2004.** Aspects of Geometry and Art. Journal for Geometry and Graphics. Vol.8, № 2, 231-241.
2. **Bartel K., 1958.** Perspektywa malarska. Warszawa: Panstwowe wydawnictwo naukowe, 585. (in Poland).
3. **Boguszewska K., 2014.** City for people on the example of Vieux Port revitalisation in Marseille. Motrol: Arch. Urb. Stud. Krajobr. OL PAN, Vol. 14 (2), 5-12. (in Poland).
4. **Differet glass and glassware in construction., 2013.** [E-resource]. URL: <http://www.bibliotekar.ru/spravochnik-33/54.htm> (date accessed: 10.07.2015). (in Russian).

5. **Kolotova O.O., 2012.** Mirror as a formative factor in modelling composition work of art. Bulletin of Cherkassy University, Vol.200, 10-16. (in Ukraine).
6. **Lavryk G.I., 2002.** Fundamentals of systems analysis. Kyiv. 140. (in Ukraine).
7. **Mitani G., 2012.** Column-shaped Origami Design Based on Mirror Reflections. Journal for Geometry and Graphics. Vol.16, № 2, 185-194.
8. **Morita K., 2011.** Some Theorems on Kissing Circles and Spheres. Journal for Geometry and Graphics. Vol.15, № 2, 159-168.
9. **Pidgornyj O.L., Shchepetova I.M., Sergeychuk O.V., 2005.** Translucent fence of houses, Kyiv, 282. (in Ukraine).
10. **Shapoval S.V., Chromenuyk O.R., 2013.** The selection of materials to the front glazing of the building. The communal property of the city, Vol.5, 23-27 (in Russian).
11. **Stepanov A.V., 2007.** Volumetrically spatial composition. Moscow, Architecture-C, 256. (in Russian).
12. **Sykta I., 2014.** The international exhibitions and their impact of the city landscape an attempt of retrospection and contemporary valorization of their influence on countryside. Motrol: Arch. Urb. Stud. Krajobr, OL PAN, Vol. 14 (4), 5-34. (in Poland).
13. **The glazing of façade, 2014.** [E-resource]. URL: <http://www.snok-c.com.ua/index.php?pageid=8> (date accessed: 10.07.2015). (in Russian).
14. **The mirror house in Italy, an architect Peter Pichler., 2014.** [E-resource]. URL: <http://luxdomik.com/2014/12/12/zerkalnyj-dom-v-italii-arxitektor-piter-pixler/> (date accessed 09.07.2015). (in Russian).
15. **The Mirrorcube., 2015.** [E-resource]. URL: <http://treehotel.se/mirrorcube/> (date accessed: 09.07.2015).
16. **Vityuk K.U., 2011.** The city of the glass cubes and cylinders. Architecton, Vol.3, 10-19. (in Russian).
17. **Yevseyenko L.M., 2007.** The effects of tinted mirrors to correction interior color range. Bulletin of the HUADA, Vol.8, 32-36. (in Ukraine).

#### ЗЕРКАЛЬНЫЕ ЭФФЕКТЫ СВЕТОПРОЗРАЧНЫХ ПЛОСКИХ И КРИВОЛЕНЕЙНЫХ ОГРАЖДАЮЩИХ КОНСТРУКЦИЙ

**Аннотация.** Приведены примеры плоских и криволинейных светопрозрачных и зеркальных ограждающих конструкций. Варианты их образования при сопоставлении с геометрическим преобразованием формы. Применено комбинаторную методику.

**Ключевые слова:** Зеркальные эффекты, геометрические преобразования, сопоставление, стекло, фасад, светопрозрачные ограждающие конструкции.



## Application of graph theory in the energy efficient architectural design

*Natalia Bolgarova*

Kyiv National University of Construction and Architecture  
Povitroflotskyi prosp., 31, Kyiv, Ukraine, 03680, e-mail: ruchinsky@ukr.net

**Summary.** Energy-efficient house is considered as a structure consisting of individual elements (volumes). To analyze their relationships with the architectural design of objects suggested to use one of the methods section of mathematics – graph theory. There are basic principles of the theory, which can be used to generate functional and spatial structure of the energy-efficient-building.

**Key words:** graph theory; energy efficient; construction design; geometric model.

### INTRODUCTION

So far, there was a steady region of interaction of architecture and mathematics has thus fairly clear structure: a certain number of tasks of urban development and architecture bulk solved certain mathematical or geometric methods. Currently developed various methods of geometrical description of the building. They can be divided into four main types – image by using the grid and lattice of identical cells, complex networks and grids, as polyhedral and polygons as graphs. Section mathematics "Graph theory" gives a large variety of methods to solve architectural problems. They allow you to adjust the functional relationships within objects, optimize search design solutions, perform compositional analysis on various aspects, etc. based on the models that can be put in the language of graph theory, which is more abstract, based on concepts that focus on binary

relations between parts, of which the whole is composed.

### PURPOSE OF WORK

The object of this article is to highlight the main principles of the individual elements linked together in a single structure – energy efficient building. The article examines how energy efficient building structure with individual elements (volumes) and highlights the main principles on which these elements are linked together, which can be used in the formation of functional-spatial structure of energy efficient building.

### MATERIALS AND METHODS

Architecture and mathematics are stable interaction region that has thus quite clear structure: a range of tasks Urban Development and Architecture bulk solved some mathematical or geometric methods. Currently are developed various methods of geometric description of the building. They can be divided into four basic types - image by using the grid and lattice of identical cells, complex networks and grids, as polygons and polyhedra, in the form of graphs. Mathematics Chapter "Graph theory" provides a large variety of methods to solve architectural problems. They allow you to adjust the functional links within sites, search optimization design

solution, to compositional analysis on various aspects etc. according to the models, which can be summarized in the language of graph theory, which is more abstract, based on concepts that focus on the binary relation between parts of which composed a whole.

## RESULTS AND DISCUSSION

Shaping is fundamental and primary step in the design of energy efficient buildings, which have different influences interaction. To streamline the process of spatial energy efficient facility is necessary to investigate the structure of the object. The structure of the architectural object can be represented as separate structures, which are combined with each other on different principles of their organization.

To optimize the design process at the stage of formation is proposed to develop a model of the internal structure of the object, its geometric shape model and its interaction with the environment in which you can manage and optimize based on the total energy evaluation model.

The basis of the geometric model are the structural elements of the object (a certain amount, for example – functional areas) and their relationships with each other, formed through interaction of technical parameters of each element to each other, as well as the interaction of elements of the environment. Changing rates of individual elements or changing relationships between them (spatial elements relative to each other) will lead to changes in the overall index of efficiency of the building. Thus it is possible to control the energy efficiency index object on the stage of a geometric model of the object

To that end, at the stage of defining the basic design tools and at the stage of the structural model is necessary to determine the parameters of each structural element of design and engineering solutions, as well as the relative positions of each structural element relative to each other.

Thus, the model which could be implemented design technique is complex struc-

tured and, in particular, contains geometric components that describe the structure of the object and the system of physical interactions and influences.

## GRAPH THEORY ANALYSIS OF INTERCOMMUNICATION TOOL AS ELEMENTS SPACE-PLANNING STRUCTURE WITH PROJECTING EN- ERGY EFFICIENT HOUSING

As you know, graph on the applied aspect – a mathematical model of the system in which the vertices are denoted its elements, and ribs – the presence of any binary relation between them. For various types of graphs using orientation may vary, restrictions on the number of links, and additional data on the top or edges.

When creating a geometric model of the architectural design of the building, particularly energy efficient, you will need to take into account both the energy influence over the environment (climate zone temperature and humidity profile, wind conditions, insolation regime, local microclimatic conditions) and all the internal interactions connections in buildings that formed space-planning, design and engineering solutions. Consideration of these factors will help to dry the schematic graph to model object interactions, optimizing that, you can influence the quality indicators of the architectural object (in particular - the energy balance), changing the model elements (graph elements).

Based on geometric models of any building (including energy efficiency) is its structural elements (certain amounts, "Thermoblocks" – functional and spatial zones) and their relationships with each other, formed on the basis of technical indicators each interaction element with each other, as well as the interaction of elements of the environment. The change of parameters of individual elements or changing relationships between them (spatial elements relative to each other) leads to changes in the overall energy index of the building. Thus theoretically is possible



to control measure energy facility at the stage of the geometric model of the object.

Creating a geometric object model starts with defining spatial relationships between elements of the object (house) – Fig.1.

In 1960 Henry Painter introduced the concept of "Count communication» («Bond graph»). Count communication is a graphical representation of a physical dynamic system. It is similar to a known block diagram and remotely on a directed graph, with the main difference that the arc relations graph are bi-directional exchange of physical energy (Fig.2), while in block diagram and oriented graphs they are a unidirectional flow of information. In addition, the connection graph can be valued. This means that the analysis can be performed on several parameters of different dimensions.

As a simulation tool, bond graphs can be used for the conceptual design phase. Counts connection consists of variables (forces), components and certain bonds. Bond graphs were used in many physical fields such as mechanics, electronics and hydraulics for modeling processes of energy transfer and behavior change system. Similarly it can be used in architecture, as well as architectural composition is a system as a set of parts, between which there are links from metabolic processes.

Each link connecting together certain elements (nodes), submitted instant action energy ( $dE/dt$ ) or force. The flow in each arc indicated by a pair of variables is called "variable power", the result (the product) by the instantaneous power connection. Variable power at each node can be divided into two types: "effort" and "flow". The effort is multiplied by the flow and gets the power that is "variable power". Examples of force-force, torque, pressure or pressure; flow-speed, current and volumetric flow.

Links with other features. One is the "half-arrow" – signs convention. Provided they indicate the direction of positive energy flow. Choice of positive direction is arbitrary, with the caveat that you need to be consistent throughout the column to the selected destination.

So, for the energy assessment of the building must be selected in the model building spatial volumes ("Thermoblocks"), which are a set of closed or open spaces inside the building with a specific functionality and internal microclimate (temperature and humidity conditions).

The next step in creating a geometric model of the building is the analysis of the list of border space between data volumes, their geometry, orientation and location relative zones. By spatial boundaries include - foundation, floors, walls, floors, coatings. In this list there are design and cuts with their geometric, design and engineering and technical indicators that are essential for energy simulation.

The geometric model of energy efficient building in completed form should be a tool that will allow architects to monitor and control all the parameters architectural design that have an impact on energy efficiency of the building. Energy rating geometrical model in all stages of design will allow the architect to make informed decisions concerning energy efficiency. The inclusion of this analysis workflow architectural design will facilitate the creation of projects that meet construction standards in the field of energy efficiency.

#### STAGES OF FORMATION OF ENERGY EFFICIENT BUILDING SYSTEM MODELS

Methods of creating residential building project are a set of techniques or operations concerning its design. Methods of designing energy efficient architectural objects are related to the need and characteristics of urban union system, space-planning, architectural design and engineering decisions that affect the formation of energy-efficient facility. Thus, the model, which could be implemented design technique is difficult structured and, in particular, contains geometric components that describe the structure and system object physical interactions and influences.

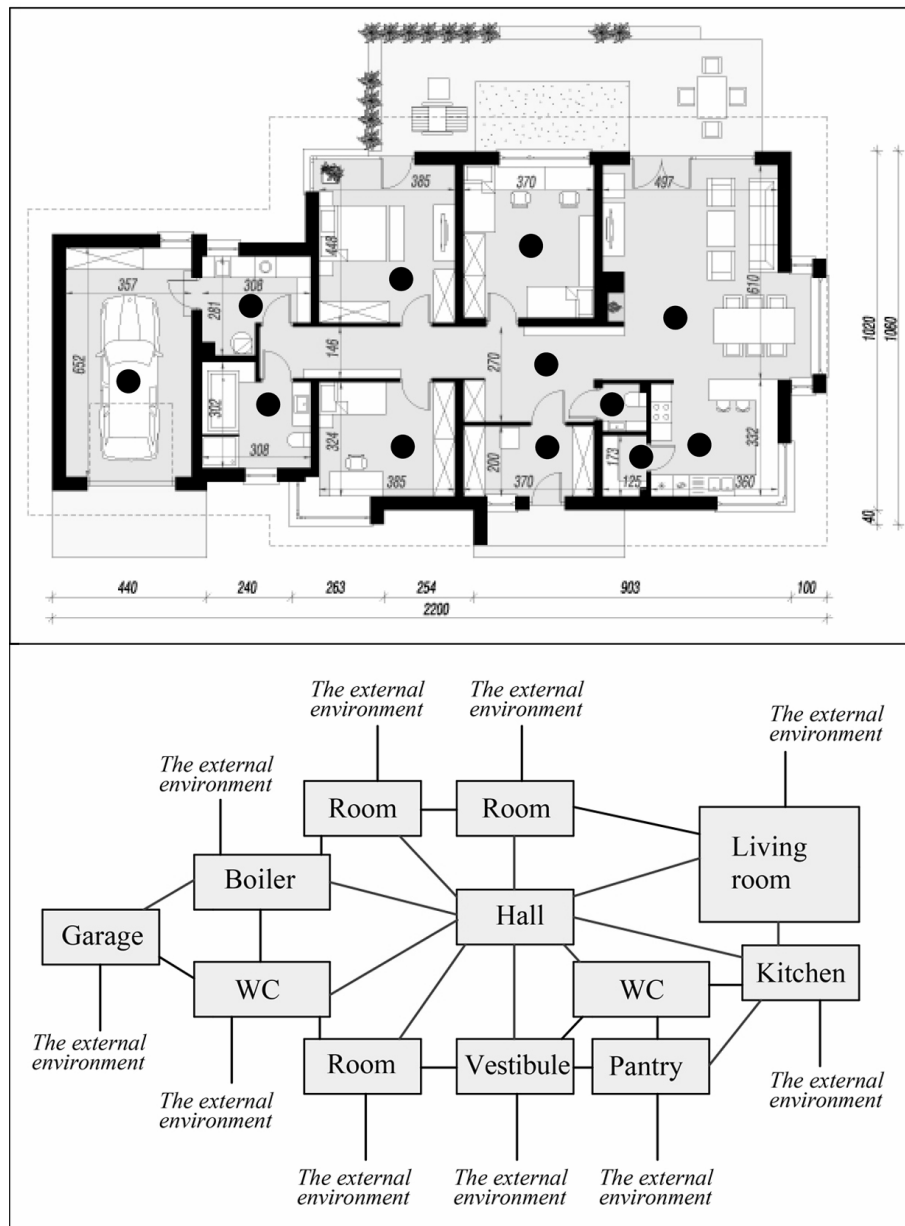

Fig. 1. Plan-story building and an undirected graph connections between elements

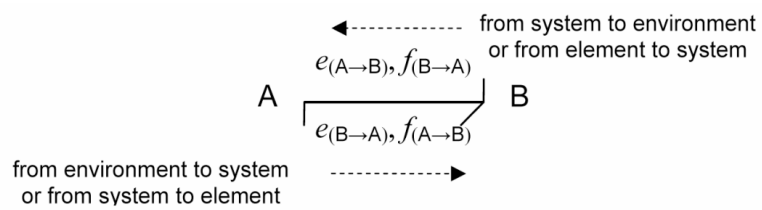

Fig. 2. Variables (power) elements and relationships defined in the "Bond graph" [5]

For structuring the process of formation of energy efficient buildings is proposed to divide it into three stages, with emphasis on the stage of forming a geometric model of the object as a determining step.

#### 1. Pre stage.

Pre-analysis is a phase formation of the target set for the design. Methodological analysis is creating a certain view of the object of design from the perspective of the design goals. The methodological approach provides a fundamental orientation predesign analysis, creates conditions for the formation of ideas, basic concepts and building the target set.

Pre-stage includes collection and analysis of information (the study of theoretical models of energy efficient housing design, analysis of the environment and its effects on the object) and determine the means that will be used in the design (schematic diagrams of space-planning structure of your design and engineering judgment).

2. Stage forming a geometric model of the internal structure of the object and its interaction with the model environment.

Step involves creating a geometric model of the object based on the structural model, its analysis and optimization.

The basis of the geometric model are the structural elements of the object (for example – functional areas) and their relationships with each other, formed through interaction of technical parameters of each element to each other, as well as the interaction of elements of the environment. Changing rates of individual elements or changing relationships between them (spatial elements relative to each other) will lead to changes in the overall index of efficiency of the building. Thus it is possible to control the energy efficiency index object on the stage of a geometric model of the object.

To that end, at the stage of defining the basic design tools and at the stage of the structural model is necessary to determine the parameters of each structural element of design and engineering solutions, as well as the relative positions of each structural element relative to each other. This stage is a

cyclical process, which alternates analysis and synthesis.

As an instrument for analyzing, the relationships of the structural elements of the object and their interaction with the environment are proposed to create a geometric model as a graph.

As a result of the synthesis of data from all elements of object interconnections emerging overall system energy balance of the building, which is a measure of energy efficiency of the facility. Equalizing the figure with the standards of energy efficiency and, in the case of non-compliance with regulations, adjusting parameters of individual elements and their interconnections, it is possible to adjust the degree of efficiency of the object.

Thus, we obtain the energy balance control system object that can become the basis of CAD construction projects on the criterion of efficiency.

3. Stage optimization and creative improvement project architectural object.

This stage is a comprehensive method of architectural design, the essence of which lies in the simulation, creating the design model of the object in accordance with the practical, aesthetic and socio-cultural features as a basis for the geometric model.

Spatial structure of the compounds in the second stage of design can be represented as a graph. Architect, coding in the graph structure necessary references are manipulated by choosing different options.

## RESEARCH OF FEATURES OF FUNCTIONAL AND SPATIAL ENERGY EFFICIENT BUILDINGS

If we consider the house as a structure consisting of individual elements, you need to identify the main principles on which these elements are linked together.

There are three principles of formation of functional-spatial structure of energy efficient building.

*1 principle.* It involves differentiation volumes for functional and social factors. The

nature of the use of space points to the basic requirements for housing - the number and characteristics of functional processes in the areas of domestic buildings.

If we consider individual housing, we can distinguish major groups of premises, which in turn are divided into individual cells and planning areas:

- General family Group (living room, kitchen, bathroom, office, etc.),
- Individual Group (bedrooms, bathrooms, closets, etc.),
- Group Service premises (boiler, etc.),
- Communications (Stairs, corridors).

Synthesizing the internal structure of the building on this principle is the main method of designing all time.

*2 principle* allows for the connection of internal and external spaces of the building with the influence of the environment. This is about mutual dependence and planning functional elements (quantity and quality of space inside the house) and climatic factors (climate zone, temperature and humidity conditions, wind mode, insolation, the presence of natural threats (seismic), local microclimate conditions – surrounding construction, geology, soils, water resources, flora areas). We consider the organization of the site and introduced its division into discrete units, garden, elements of landscape design, and some temporary buildings and structures, exterior decoration, etc.). And, most importantly, the interdependence of functional-planning elements and climatic factors transformed to create certain desired spatial organization of receptions in the building.

For example – the minimum front enclosing surfaces, elongated latitudinal orientation of the building facade to the south, modeling the internal structure taking into account passive solar insolation and heating, reducing the area of the northern facade using slope roofing, glass facades differentiation (maximum windows on south facade, minimal – on north), consideration lifting height of summer and winter sun – protection from overheating southern facade (performances of a roof, slats, extension), the use of passive systems use solar radiation (direct radiation).

*3 principle* of formation of functional and spatial structure of energy efficient buildings include the use of known techniques inherent in energy efficient buildings.

Maximum compact plan and volume, thermal zoning and planning functional groups in the building, excluding technical premises with heating circuit, the color of the building surfaces, which improves heat flow, placement techniques to improve planning and reduce heat flow - partial hollow building in the ground, placing Atrium premises, installation of buffer zones (for heat accumulation - built and added to the greenhouse southern orientation, insulated to prevent heat loss - unheated buffer areas of the northern facade); features construction materials enclosing structures, ensuring minimal heat transfer coefficient, triple glazing of filling the space between the panes with argon gas or low-emission glass, creating airtight building shell inside the entire surface protecting, ensuring the tightness of connections of transition (the exclusion of "cold bridges").

Based on principles proposed modeling can be found willing cooperation of combinations of three-dimensional elements of different types of groups that can be classified in terms of energy efficiency.

Different combinations of elements interaction groups planning buildings can be summarized in table ready geometric variations functional and spatial solutions. In other words, we can assume that under given conditions based on the number of items can be given in advance to identify all possible variants of their arrangement and the selecting are only efficient in terms of energy efficiency.

Using these principles of forming the structure of energy efficient buildings, you can speed up and streamline the design process and to create spatial relationships of combinations of elements of a building under specified conditions. In further research is planned to create a geometric model of the object by using the principles of formation of its functional and spatial structure.

## CONCLUSIONS

1. It considered the possibility of using one of the methods branch of mathematics Graph theory in architectural design of energy efficient buildings as an analysis tool designed object relationships. There are highlighted two main elements create a geometric model of energy efficient buildings - spatial cell ("Thermoblocks") and their relations (constructions). Highlight geometric and engineering source data and spatial structures of cells that bind them are required for energy analysis of the geometric model building. In further studies will be conducted analysis of all possible links between vertices, edges are planned scheme.

2. The article was systematized stages of the design of energy efficient buildings, as well as allocated determining step simulation, which can carry out the management of geometric model of the internal structure of the object to improve the overall energy efficiency.

3. The article deals with energy efficient building as a structure of individual elements (volumes) and highlights the main principles on which these elements are connected to each other, which can be used in the formation of functional-spatial structure of energy efficient buildings. Using these principles of forming the structure of energy efficient buildings, you can speed up and streamline the design process and to create spatial relationships of combinations of elements of a building under specified conditions.

4. The geometric model of energy efficient building in completed form should be a tool that will allow architects to monitor and control all the parameters architectural design that have an impact on energy efficiency of the building. Energy rating geometrical model in all stages of design will allow the architect to make informed decisions concerning energy efficiency. The inclusion of this analysis workflow architectural design will facilitate the creation of projects that meet construction standards in the field of energy efficiency.

## REFERENCES

1. **Afanasyeva O.K., 2009.** The architecture of low-rise residential buildings with renewable energy sources. The thesis is on the competitor. Ouch. step, PhD. Arch. Moscow, 39-53. (in Russian).
2. **Bolgarova N.M., 2013.** Steps to creating a system model for energy efficient buildings, Collected Works "Construction and Technical Safety" edition 48, Simferopol, 156-159. (in Ukraine).
3. **Bolgarova N.M., 2014.** Studies of the formation of functional and spatial organization of energy efficient buildings, Scientific and technical collection "Energy efficiency in construction and architecture". Edition 6, 23-26. (in Ukraine).
4. **Bolgarova N.M., 2015.** Initial data to create geometrical model of space energy efficient buildings, Scientific and technical collection "Energy efficiency in construction and architecture". Edition 7, 31-34. (in Ukraine).
5. **Gazda A., Żółkiewicz Z., 2012.** Thermal and physical properties of some refractory layers used in lost foam technology, Teka Komisji Motoryzacji i Energetyki Rolnictwa XII-2, Poland, 47-52. (in Poland).
6. **Gero J.S. and Tsai J.J-H., 2005,** Archibond graphs in a unified representation for building design, Sydney, Australia
7. **Friedman I., 1983.** Scientific methods in architecture, Moscow, Stroiizdat, 7-55. (in Russian).
8. **Harari F., 2003.** Graph Theory, Moscow: Mir, 13-18. (in Russian).
9. **Kapica J., Ścibisz M., 2013.** Employing empirical mode decomposition to determine solar radiation intensity curve, Teka Komisji Motoryzacji i Energetyki Rolnictwa XIII-1, 65-70. (in Poland).
10. **Kashchenko T.O., 2012.** Improving the energy efficiency of residential buildings based on optimization of their form. - Manuscript. Dis. candidate. architect, Kyiv, 103-126. (in Ukraine).
11. **Molchanov V.M., 2003.** Theoretical bases of designing of residential buildings: Textbook. 2nd ed., Rostov n/D, Feniks, 26-49. (in Russian).
12. **Polak R., Dziki D., Krzykowski A., Rudy S., Serwatka Z., Tomiło J., 2013.** Acquisition and economic use of geothermal energy, Teka Komisji Motoryzacji i Energetyki Rolnictwa XIII-1, 133-138. (in Poland).

13. **Polui B.M., 1989.** Basics of architectural forming in the harsh climate (environmental aspects). Novosibirsk. (in Russian).
14. **Ruchynska N.M., 2013.** Graph theory as a tool to analyze the relationship of elements of space-planning structure in the design of energy-efficient housing, Scientific and technical collection "Energy efficiency in construction and architecture". Edition 4, 244-248. (in Ukraine).
15. **Sergeichuk O.V., 2001.** Geometric modeling of physical processes in the form of optimizing energy efficiency of buildings. - Manuscript. Dis. Doctor. Sc. Science, Kyiv, 9-18. (in Ukraine).
16. **Tatt U., 1988.** Graph Theory, Moscow, Mir, 16-19. (in Russian).

#### ПРИМЕНЕНИЕ ТЕОРИИ ГРАФОВ В СТРОИТЕЛЬНОМ ПРОЕКТИРОВАНИИ

**Аннотация.** Энергоэффективный дом рассмотрен в виде структуры, состоящей из отдельных элементов (объемов). Для анализа их взаимосвязей при архитектурном проектировании объектов предложено применить один из методов раздела математики – теорию графов. Показаны основные принципы теории, которые могут быть использованы для формирования функционально-пространственной структуры энергоэффективного здания.

**Ключевые слова:** теория графов, энергоэффективность, энергоэффективная архитектура, структура архитектурного объекта, проектирование, геометрическая модель.

## Development of bell type water well with wide gravel filter

*Krishna Kayastha*

Kyiv National University of Construction and Architecture,  
Povitroflotskyi Prospect, 31, Kyiv, Ukraine, 03680, e-mail: kriskaes@gmail.com

**Summary.** The purpose of this article is to present a new bell type water well construction with a wide gravel filter and its application. The construction of the water well has been developed and research has been conducted using physical and electrical modelling as well as in the practical field. Researches in this work are of analytical and experimental character. As the results of the research, optimal physical parameters of the constructions have been found and analytical – empirical formulae have been derived to calculate hydraulic parameters. Recommendation for application has been presented. The results received in this work can be used for the application of well construction. Further research is required to improve the physical and the hydraulic parameters of the proposed construction. The work has scientific and practical interest.

**Key words:** electrical and physical modelling, water well construction, ground water, bell type water well, water supply, irrigation.

### INTRODUCTION

In the context of widespread growth of population, and industrial and agricultural production, water demand for drinking purposes, irrigation, etc. has been constantly increasing. Ground water is playing a major role in meeting these needs. Groundwater is extracted through different types of wells. To meet such needs, generally water wells are constructed with steel screens which are very expensive. If the geological condition of the construction site is of consolidated earth or rocks above the aquifer, the water well can

be constructed without the costly screen which is called as filter less well. These wells have high unit discharge, and less operation cost. In this case the water intake is formed under hard ground or rock which is above the water bearing aquifer. However, this construction can only be used if the well consolidated subsoil or rock is available. In the unconsolidated soil or sandy soil these constructions cannot be designed [1, 2].

### AIM

The aim of the article is to illustrate the new bell type water well construction and its efficiency which can be applied in any geological condition.

**Creation of new type water well.** Colmatage is the serious problem in the well of traditional construction [3]. Wide gravel packing contributes significantly to the discharge of the well [4]. Considering these facts the study of the traditional wells constructions with screen and without it has been conducted to find out not costly well construction that is hydraulically efficient. This study led to the creation of the new bell type water well (BWW) with wide gravel screen (Fig. 1). It has less hydraulic resistance, less metal content and can be applied in a confined as well as in non confined aquifer. The funnel of the bell type water well functions as the intake. It is lowered into the well and

wide gravel is filled around it to act as a filter (Fig. 1).

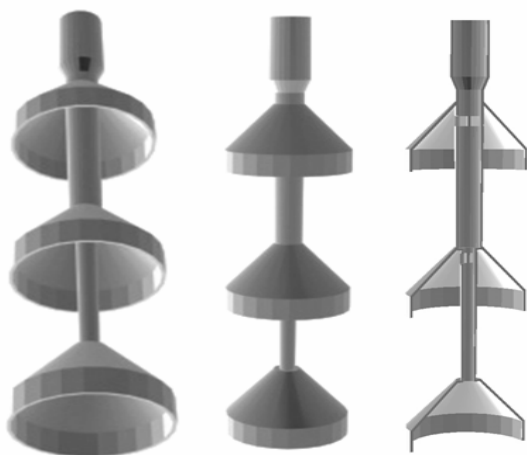

**Fig. 1.** Three-dimensional Model of Bell type Water Well Construction (BWW)

The vast majority of remote area populations consume low quality water and most of this population uses the traditional dug type open water well [5, 6]. These traditional wells can be replaced with the BWW where the well is protected from surface water contamination and the modern drilling technology allows the construction of such wells in different types of subsoil [7, 8].

Research has been conducted with electrical modelling, physical modelling and in the field in order to study the BWW. These studies included an assessment of the hydraulic and physical parameters of the wells with one, two and three tiers of bell type intake including the estimation methodology of the well discharge and suffusion processes. The well might be of the single or multilayer and might be constructed in a confined or non-confined aquifer. From these wells an average discharge of 200 to 300 m<sup>3</sup>/day can be obtained. The construction of the well can be made using cheap materials like PVC pipe, concrete pipe, gravel, etc. (while in the construction of the traditional wells, costly stainless steel and non-ferrous metals were required). It opens new perspectives in the design of water well for the drinking water as well as irrigation in the agricultural systems

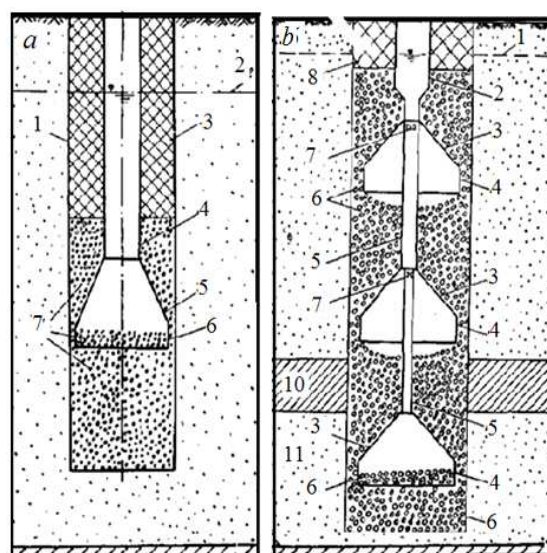

**Fig. 2.** Bell type Water Well Construction (BWW): *a* – Single Tier Construction, *b* – Multi Tier Construction

especially in the countries where the ground water development is taking rapid speed like in Nepal, India, and Bangladesh etc. [9, 10, and 11].

**Single-tier bell type water well construction** is designed to withdraw the groundwater from unconfined and confined aquifer of different level of water pressure. The geology of the aquifer or the above the aquifer may be composed of loose sandy deposits or compact soil and hard rock. Unlike in the traditional water well construction, in the BWW well, the metal screen is not used, and the use of metal is minimized. All the construction can be made with low cost plastic pipes or other local materials such as reinforced cement, concrete, wood or bamboo. The hydraulic resistance of the construction is not high. The lower water intake part is made of cylindrical funnel type and filled with gravel around the intake. The BWW (Fig. 2, *a*) consists of one large diameter trunk (600...1200 mm), gravel packing, casing 4, funnel 5 with a cylindrical edge 6 which is descended below the ground water level 2, and waterproof packing material 3. The gravel pack is filled around the cylindrical intake. The form of funnel intake bears the underground earth pressure and its ex-



tended lower part increases the area of infiltration.

Gravel pack around the cylindrical portion of the intake has sufficient mass resulting in high filtration rate and increasing the well discharge. The gravel pack stops the sand particles from entering the water, delivery pipe, and pump. Ground water flows through the gravel packing 7 to the flat bottom part of cylindrical intake and is raised to the well delivery pipe. The water is withdrawn with the well pump that is fixed below the groundwater level 2.

**The multi-tier bell type water well construction** is designed with a number of wide cylindrical water intakes connected with simple pipes and filled with packed gravel around the intakes. Multi-tier well structures can be used in confined 11 or unconfined 9, single or multi layer water-bearing strata (Fig. 2, *b*).

The multi-tier BWW (Fig. 2, *b*) consists of one large diameter trunk (600...1200 mm), gravel packing 6, casing 2, funnel 3 with a cylindrical edge which is descended below the ground water level 1, and connecting pipes 5 with openings 7, waterproof packing material 8. The gravel pack 6 is filled around the cylindrical intakes. The form of funnel intake bears the underground earth pressure and its extended lower part increases area of infiltration.

The cylindrical water intakes are placed in the water bearing aquifers (in these case, multi layers aquifers) which allows water to be withdrawn uniformly from the water bearing aquifers. The intakes are not placed in the impermeable layer 10. Ground water flows through the gravel packing 6 to the flat bottom part of cylindrical intakes and is raised to the well delivery pipe. The water is withdrawn with the well pump that is fixed below the groundwater level 1.

**Methods of improvement of hydraulic efficiency.** Fig. 3 shows the further developed BWW in which hydraulic parameters are more efficient. Fig. 3a shows a BWW construction where instead of simple blind pipes, perforated or slotted pipes 1 are used to connect the cylindrical intakes. The mate-

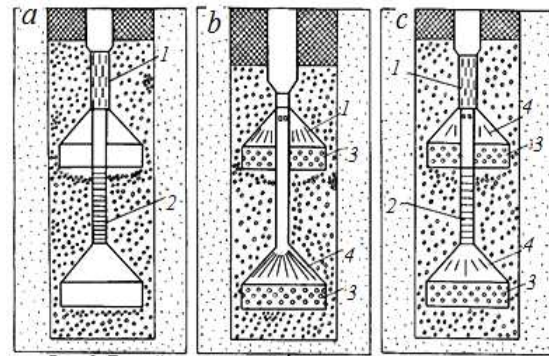

**Fig. 3.** Bell type Water Well Construction: *a* – with perforated screen, *b* – with perforated conic part, *c* – with perforated screen and conic part

rials of the connecting pipes and the cylindrical intakes might be different. In this case, the water intake area is higher than in the simple BWW designs, and respectively has less hydraulic resistance.

Fig. 3, *b* shows another updated construction where the funnels are perforated 3 or slotted 4. Fig. 3, *c* is given another updated multi-tiered BWW where all the parts of the constructions are perforated 3 or slotted 4. The wells of this design have maximum water intake surface area and flow rate. In this case the performance of the gravel pack is increased significantly. This is the most hydraulically efficient construction.

In the updated BWW, in place of perforated or slotted connecting pipes 2, a porous cement concrete pipe can be used. The efficiency of the porous concrete pipes can be enhanced using multiply layers of properly selected gravels of different sizes. The size of the gravels of concrete depends upon the size of the sand particles in the aquifer.

**Application of bell type water well to purify ground water and to rehabilitate the well.** Today many regions in the world are facing serious problems, due to the high content of iron in groundwater [12]. Backwashing methods have been using to remove iron from ground water [13]. The multi-tier BWW construction for wells with the wide gravel filter can be used to remove iron from groundwater directly in the aquifer by nonchemical circulation methods (Fig. 4). In this method the state of the iron content is

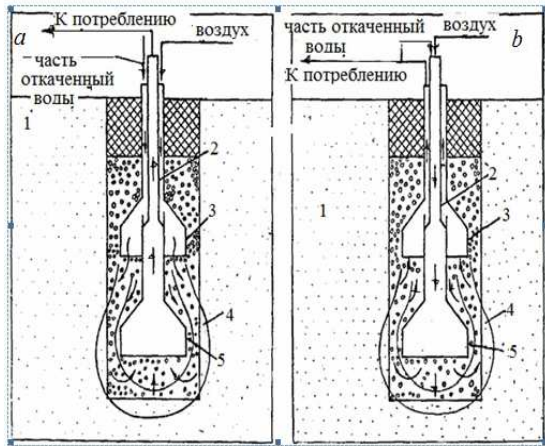
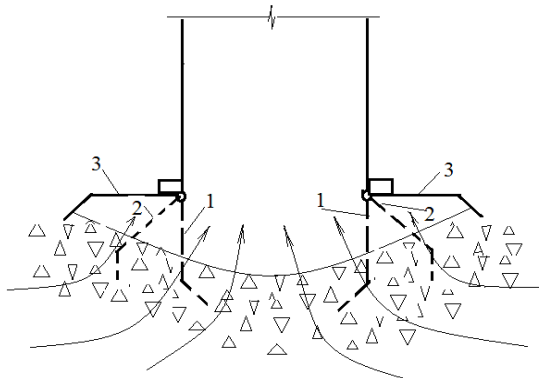

**Fig. 4.** De-Ironing of Ground Water in Aquifer with BWW:  
*a* – injecting through upper intake, *b* – injecting through lower intake

transformed from a dissolved state to an insoluble form by injection of aerated, oxygen-saturated in the circulation zone of aquifer. The insoluble forms of iron will be held underground by the porous rocks or gravel pack when pumping water.

The basic idea of removing ground water iron with multi-tier BWW with gravel filter is, one cylindrical intake is used for injecting the oxidant and other intakes are used to pump out the treated water (Fig. 4). The same principle can be applied to remove the chemical colmatages from the well and other rehabilitation works.

**Foldable bell type water wells.** It is difficult and sometimes impossible to drill deep



**Fig. 5.** Foldable Water Intake of BWW:  
*1* – Initial position of the conic part, *2* – Middle position of the conic part, *3* – Final position of the conic part

water wells with large diameters. In the practice of deep water well drilling of large diameters, generally the well is drilled with a small diameter just enough for casing pipe. And the well is drilled widely only in the portion of where the water well screen is placed. Similarly in the case of drilling of deep well the foldable BWW well can be applied where the water intake cylindrical part is unfolded into the aquifer. After lowering the intake of well to a point where the diameter of the well is wide enough for the construction, the water intake is unfolded (Fig. 5, 6).

**Study the BWW with the method of elektrohydrodynamics analogy (EHDA).** The method is based on the analogy of differential equations for potential distribution on electrically conductive paper and fluid motion in porous media [14]. The Research works of the BWW have been carried out using known methods of simulation of axis symmetric filtration in electricity conductive paper models (EHDA) proposed by P.F. Filchakov [15, 16]. Simulation of axis symmetric filtration in the electrical model can be presented by the Laplace equation given below, which describes the stationary distribution of water pressure in the filter area and the potential distribution in the electrically conductive paper.

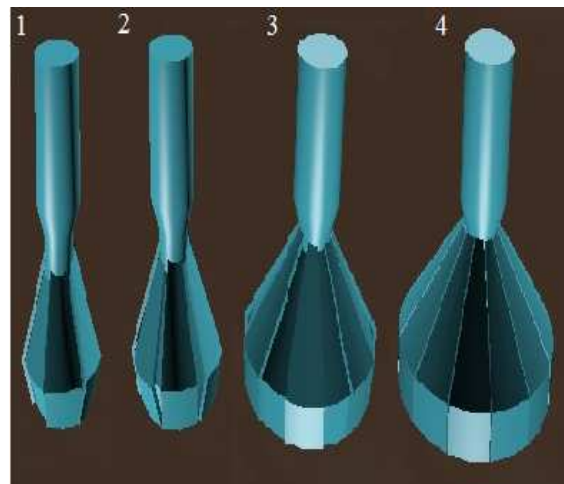

**Fig. 6.** Three-dimensional Model of Foldable BWW Construction: *1* – Initial position, *2, 3* – Middle positions, *4* – Final position

$$\frac{\partial}{\partial r} \left( K r \frac{\partial H}{\partial r} \right) + \frac{\partial}{\partial z} \left( K r \frac{\partial H}{\partial z} \right) = 0, \quad (1)$$

where  $H = H(r, z)$  – the filter head;  $r, z$  – Cylindrical coordinates;  $K$  – Permeability coefficient of the aquifer. Then equation (1) describes the two dimensional filtration, and it can be simulated in the electric conductivity model. If we take  $K \cdot r$  as a variable coefficient of filtration, the electrical conductivity should follow the laws:

$$\sigma_z = \text{const}, \quad \sigma_r = Kr, \quad (2)$$

where  $\sigma_z$ , and  $\sigma_r$  – specific electrical conductivity in the vertical and horizontal directions, respectively.

To set the electric conductivity according to equation (2), it is necessary to make the model attach several sheets different length of electrically conductive papers. The length of the lower sheet of paper must be equal to the length of the entire model. The following list is attached on the top of it and must be shorter than the value of:

$$\Delta r_2 = M \left( \frac{1}{R_1} + \frac{1}{2} \frac{1}{R_2} \right), \quad (3)$$

Each subsequent sheet must be attached on the top of it and must be shorter than the value of:

$$\Delta r_i = \left( \frac{1}{R_{i-1}} + \frac{1}{R_i} \right) \frac{M}{2}, \quad (4)$$

Where  $M$  – coefficient of proportionality which is selected as per the convenience of modelling and taken equal to  $M = 4000$ ;  $R_i$  – resistance of the  $i$ -th sheet of paper on the square cm,  $i = 3, 4, \dots, n$ ;  $n$  – the number of sheets. Basic research models for single-tier and multi-tier BWW are shown in Figures 7, *a* and 7, *b*. In order to reduce the model scale errors the water intake area is made in the

larger scale without distorting the picture of axis symmetric filtration.

**The construction parameters and simulation options of the wells.** To evaluate the performances of well constructions, research has been carried out in the electric conductive paper model using elektrohydrodynamics analogy method (EHDA) changing different physical and hydraulic parameters of the well construction and the aquifer (Fig. 8). The physical and hydraulic parameters of the construction are radii of the water intake and gravel packing  $r$ , the depth of immersion of the upper water intake  $c$ , depth gravel packing  $h$ , the distance between the water intakes  $b$ , and resistance gravel packing  $R_{gr}$ . The thickness of the aquifer  $m$ , is kept constant in the model and was equal to 200 mm (see Fig. 7). All the experiments are carried out bringing the relative parameters to the thickness of the aquifer.

$$\bar{r} = r/m, \quad \bar{h} = h/m, \quad \bar{c} = c/m, \quad \bar{b} = b/m.$$

In the experiment, the relative conductivity resistance of the gravel packing was brought to the ratio of the conductivity resistance of the aquifer  $R_{aq}$ :

$$\bar{R} = R_{aq} / R_{gr}.$$

In the experiments the dimensionless parameters were changed, in the following ranges:

$$\bar{r} = 0.05 \dots 0.015; \quad \bar{h} = 0 \dots 1; \quad \bar{c} = 0 \dots 0.3; \\ \bar{R} = 10 \dots 50.$$

**Effect of the water intake positions and the dimensions of the gravel packing on the well discharge.** Optimal depths of the intake for different  $\bar{c}_{on}$ , and different  $\bar{r}$ , were experimentally determined. The experimental data was mathematically processed and the following empirical formula was derived to determine the optimal depth of the intake as the function of the radius of the intake.

$$\bar{c}_{on} = 0,418 + 0,146 \lg \bar{r}, \quad (5)$$

To simulate gravel packing, conductive papers were used which have resistances 10, 20, 30, 40 and 50 times smaller than the resistance of the paper simulating the aquifer. Based on the experiments, the discharge curves are plotted as a function of the water intake radii, and the resistance of the gravel

packing. The experiment shows the significant effect of gravel packing on the well discharge (Fig. 9). The Fig. 9 shows the change in the nature of the flow rate at different radii of intake and the different resistances of gravel packing.

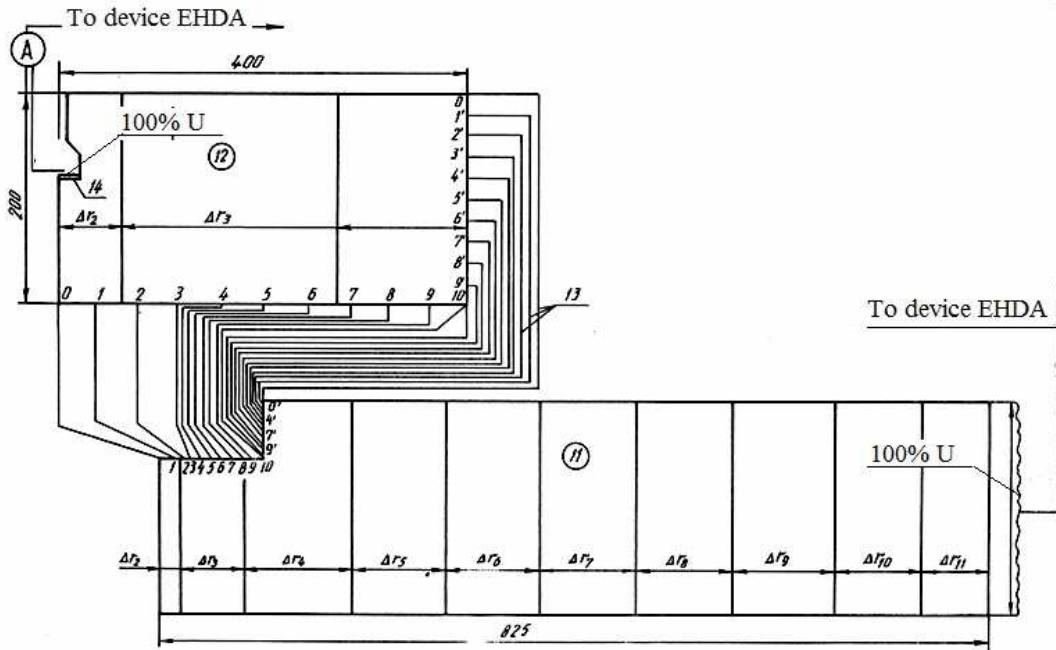

**Fig. 7, a.** Electrical Modelling of Single-tier BWW: 0...10 – Pin Connections, 11 – Aquifer, 12 – Intake area, 13 – Connecting cable, 14 – Current receiver, A – Ampermeter

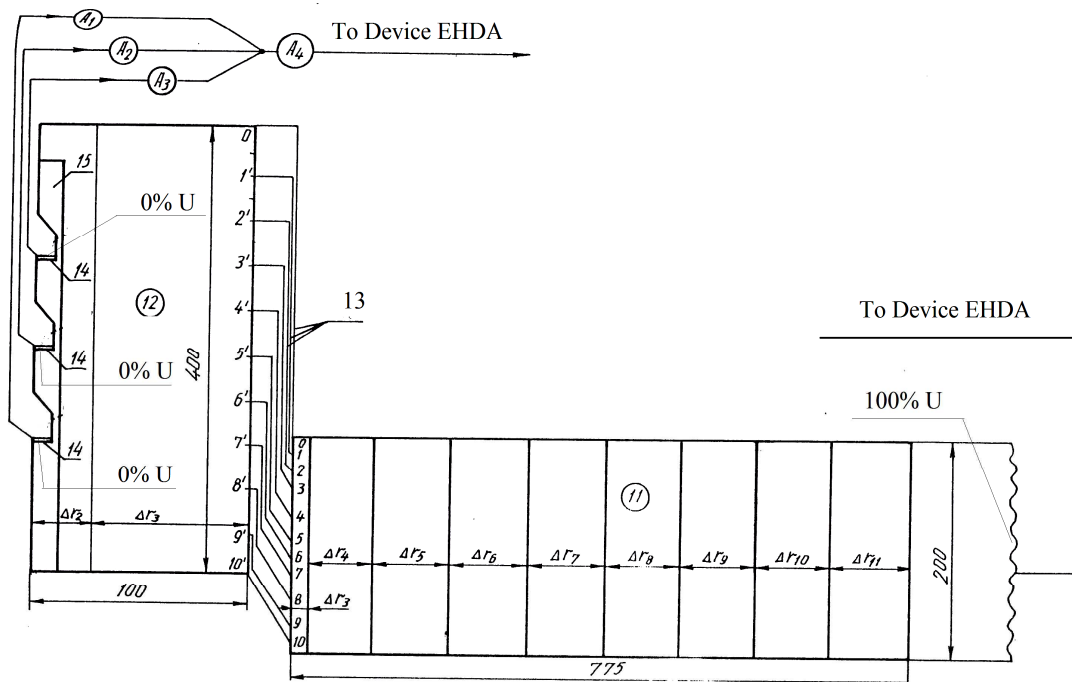

**Fig. 7, b.** Electrical Modelling of Multi-tier BWW: 0...10 – Pin Connections, 11 – Aquifer, 12 – Intake area, 13 – Connecting cable, 14 – Panchishin Current receiver, A – Ampermeter



Depending on the water intake position, the formula for the optimal depth of gravel packing is determined  $\bar{h}_{on}$  :

$$\bar{h}_{on} = A\bar{r}^2 + B\bar{r} + C, \quad (6)$$

The coefficients for different values of the relative resistances are given in Tab. 1.

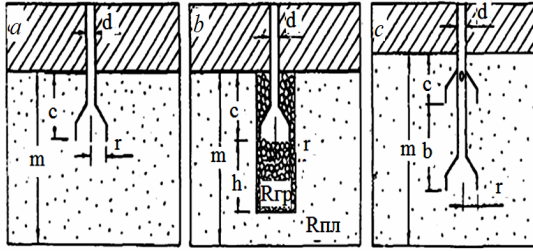

**Fig. 8.** Bell type Water Well Construction: a – one tiered without gravel filter; b – two tiered with gravel filter; c – two tiered without gravel filter

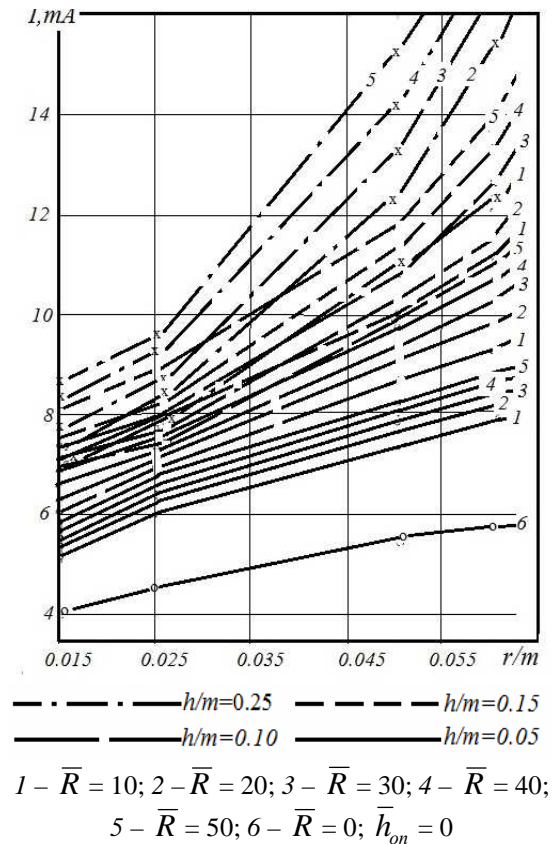

**Fig. 9.** Current Flow depending upon different resistance of gravel pack of the aquifer and the radius of the water intake

**Table 1.** Coefficients *A*, *B*, *C*, on different relative resistances for the calculation of the optimal depth of gravel packing

$\bar{R}$	<i>A</i>	<i>B</i>	<i>C</i>
10	97,14	-2,88	0,101
20	91,43	-2,66	0,124
30	62,86	-0,514	0,109
40	109,14	-2,87	0,148
50	120,57	-3,12	0,165

**Electro hydrodynamic flow net analysis.** Analysis of the influence of the nature of filtration to the discharge of the well of un-traditional type is very important. EHDA experimental setup is used in teaching and research purposes to obtain flow nets for selected groundwater flow situations with different boundary conditions using the electrical analogy concept [17].

The hydrodynamic flow net from electrical analogy gives a visual presentation of the flow process in the aquifer and it gives a clear understanding of the processes occurring near the intake (Fig. 10). The overall picture of the flow of water to the intake area is a hemispherical-radial with a sharp de-

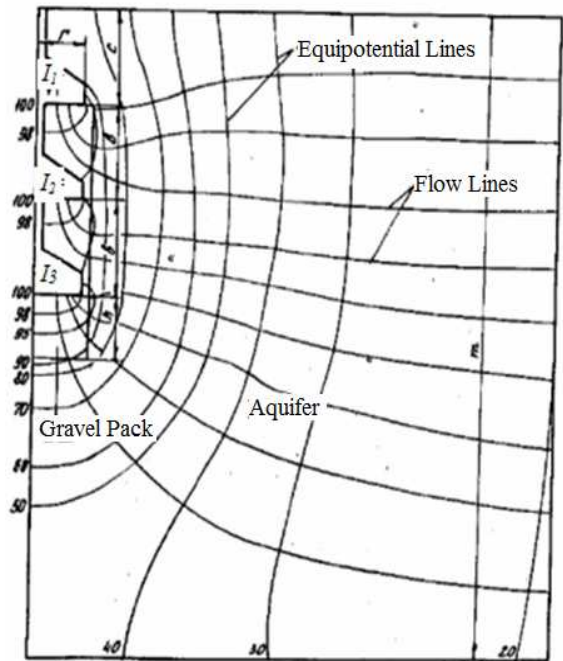

**Fig. 10.** Electrohydrodynamic infiltration flow net

crease in pressures (equipotential) at the cylindrical intake and smoothly flattens to the periphery of the well.

It should be noted that the main flow of water goes through the perimeter side of the cylindrical part. The central part of the intake, along the axis of the well has a small flow rate and is in the "dead" zone. This implies that the flow rate will be maximum at the wall of the intake cylinder and minimum at its centre.

**Study of the well using the Physical Model.** A special physical model has been built with real sand, gravel, and non-pressure water head. The study of drawdown and discharge relationship has been carried out (Fig. 11). The physical model consists of a cylindrical filtration tank 1 with a diameter of 900 mm, a height of 1200 mm which represents the aquifer. The BWW construction is placed in the centre surrounded with gravel packing 3. The water is supplied to the tank from the reservoir 12 through the pump 11. The flow energy dissipater 8 was installed to maintain the laminar flow. The water level in the tank is maintained by means of an overflow pipe 15. The discharge of the well in the model is taken via siphon 13 and supplied to a measuring tank 14 installed a triangular weir. The siphon is charged using the vacuum pump 7. The water flow in the pipeline

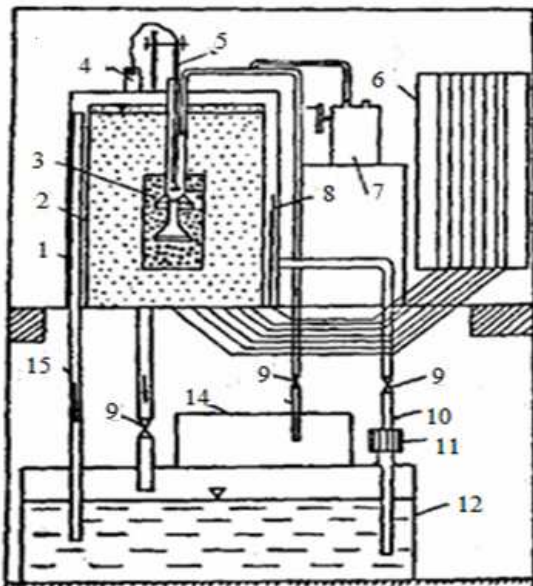

Fig. 11. Physical Model with sand and gravel

10 is regulated by the valve 9. The discharge is measured by the triangular weir of the measuring tank 14. The water levels in the intake area are recorded using piezometers 6. According to the results of research, the maximum the hydraulic resistance of the well structure is within 5...8% of the total draw-down.

Study of the discharge relationships in the multi-tier well is carried out in the hydraulic stand (Fig. 12).

**Study of the wells in field conditions.** In order to study in the practical field two wells of natural sizes were drilled on the northern outskirts of the city of Cherkassy, in the coastal area of the Kremenchug reservoir, Ukraine. The depth of the well is 15.85 m, drilling diameter is 720 mm. As the water intakes were installed two bell type intakes with a diameter of 620 mm cylindrical portion, connected by a pipe of 219 mm diameter and a length of 15 m. The length of each funnel is 650 mm and casing diameter 273 mm. The bottom funnel was filled with a depth of gravel 1.4 m and around the intakes and the connecting pipes also filled with the same gravel. The total depth of gravel packing is 5.5 m. A piezometer was installed in the well. Well discharge is obtained as of 6 m<sup>3</sup> / h by draw down of level of 1.5 m, specific yield – 4 m<sup>3</sup>/h. Well depth of single-

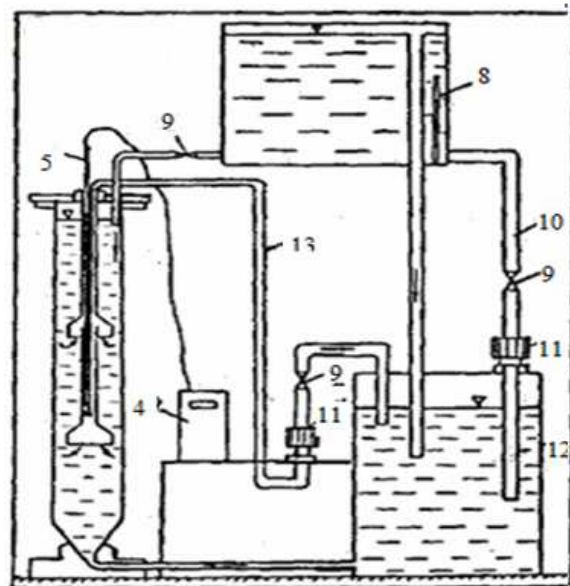

Fig. 12. Hydraulic Stand

tiered structure is 6 m, diameter 760 mm drilling. The length of the funnel is 1160 mm, diameter of the cylindrical part 620 mm. Since the lower, inside edge of the socket is concave; the edge has a diameter of 520 mm. The upper end of the funnel is welded and the casing has a diameter of 219 mm. The funnel was installed at a depth of 12.67 m and fill up with gravel with a thickness of 3.33 m.

Gravel is also filled above the funnel intake part. The total length of gravel packing is 9.5 m. A piezometer of 50 mm diameter is installed in the gravel packing. The discharge 10.1 m<sup>3</sup>/h is obtained with the drawdown of 2.22 meters. The specific flow rates of 4.6 m<sup>3</sup>/h noted with drawdown of 1.68 m. respectively 6.7 m<sup>3</sup>/h and 4 m. In both cases, the pumping was conducted for 5 hours and the water levels were stabilized after 20 minutes. In this case the water level in another well at the distance of 10.7 m was observed with a noted drawdown of 0.07 to 0.08 m.

#### Methods of Discharge calculations.

Considering the different natural conditions and the complex shapes of the well, the analysis of discharge is conducted, based on electric analogy models in pressure conditions. To reduce these errors to a minimum, the calculations were carried out in relative terms. For the ratio, the measurement is taken on the same model in the initial conditions. According to the theory of electrohydrodynamic analogy, the relative discharge of wells can be calculated by the following equation:

$$Q = \frac{Q_H}{Q_C} = \frac{I_H}{I_C} \xi, \quad (7)$$

Where  $Q_H$  and  $Q_C$  are the flow of imperfect and perfect wells respectively. In perfect wells, the relation of well screen length to the depth of aquifer is equal.  $I_H$  and  $I_C$  are the value of current in the model of the imperfect and perfect wells;  $\xi$  is the correction coefficient for voltage fluctuations on the model current receiver:

$$\xi = \frac{U_C}{U_H}. \quad (8)$$

Here  $U_C$ ,  $U_H$  are the voltages at the current receivers of perfect and imperfect wells. The voltage of the model was fixed as a constant 20 V. Therefore,  $U_C = U_H$  and hence,  $\xi = 1$ . Then the equation (7) comes out as:

$$Q_H = \frac{I_H}{I_C} Q_C, \quad (9)$$

Discharge of the perfect well can be determined by the Dupii formula:

$$Q = \frac{2\pi K m S}{\ln(R/r)}, \quad (10)$$

For the relative values, the denominator takes the value for a perfect well, and the numerator the value for imperfect well (BWW) working in the same environmental conditions. This value is less than one and it indicates the reduction factor of the discharge due to partial immersion of the well screen in the aquifer. To calculate the well discharge, it is necessary to know the discharge rate reduction ratio  $Q_H/Q_C$ , determined by modelling as the current reduction ratio  $I_H/I_C$ .

The value of current of the well model:

$$I_H = f(r/m, c/m, b/m, h/m), \quad (11)$$

$I_H$  and  $I_C$  are determined by conducting experiments on EHDA models. The rest values can be extracted from Fig. 9.

In our case:

$$I = I_H.$$

The value of current as the function of the relative radius of the perfect well can be obtained by the following empirical equation:

$$I_c = 61,5\bar{r} + 17,2. \quad (12)$$

Solving the equations (9) and (10) and substituting them to the equation (12) we ob-

tain an equation for discharge calculation of the well for the condition of confined aquifer:

$$Q = \frac{2,73KmSI}{\lg(R/r) (61,5\bar{r} + 17,2)}, \quad (13)$$

where  $I$  – value of the current in the model mA; 61,5 and 17,2 – conversion coefficients from model (prototype) to real well, mA;  $R$  – radius of influence of the wells,  $m$  – depth of aquifer;  $K$  – permeability coefficient of the aquifer; values of  $K$  for Ukrainian aquifers are given in the work of Olena Voloshkina [18];  $S$  – drawdown of the ground water level; water intake radius  $\bar{r} = r/m$ .

Considering the suffusion processes, the permissible discharge of the BWW can be determined by the equation:

$$Q_{perm} = 0,67 \vartheta_{perm} \pi r^2, \quad (14)$$

where 0.67 – coefficient taking into account of the uneven inflow,  $\vartheta_{perm}$  – Permissible flow velocity which depends on the size of gravel package and radius  $r$  of water intake.

## CONCLUSIONS

1. Bell type water wells of single tier can be used with gravel packing, and without it. The multi-tier wells must be used only with gravel packing.

2. The discharge of the wells mainly depends on the size of gravel packing, not on the number of intakes. Therefore, during the development of this design it is advisable to start with single tier intake with gravel packing of the depth of 3...5 meter for the small discharge.

3. The discharge of the single-tier well increases with the increase of the intake radius, size of gravel packing, and the immersion depth of the intake up to one third of the depth of the aquifer. Velocity for the inflow increases from the axis to the edges of the cylindrical intake (almost from zero to a maximum).

4. The discharge of the multi-tier wells increases with the distance between the intakes only up to a certain value, which is calculated depending on the radius of the intake. The water well pump should be placed between the upper and lower intakes.

5. Hydraulic resistance for the well is small and it can be used for the discharge up to 200 300 m<sup>3</sup>/day, in unconfined and confined aquifers. Application of this well design along with traditional wells will help resolve the problem of ground water supply to rural populations as a source of drinking water as well as for irrigation.

## REFERENCES

1. **Malukhin N.G., Drobadenko V.P., Timoshenko S.V., Bogdanov P.V., 2010.** Features of the filter less wells construction in fine-grained rocks. Razvedka i Okhrana Nedr (Exploration and protection of mineral resources), Number: 3, All-Russian Research Institute of Mineral Raw Materials. N.M. Fedorovsk, Moscow, ISSN: 0034-026x, 38-39. (in Russian).
2. **Bogomolov G.V., Stankevich R.A., 1978.** Besfiltrovye vodozabornye skbjhiny v rykhlykh porodakh (Filter less wells in consolidated rocks). Tiorya i praktika. Theory and practice device. Minsk: Science and Technology, 152. (in Russian).
3. **Boreng R., Vikane O., Hagen T., Sorhaug E.A., 1998.** Stimulation treatment and evaluation of gravel packed well; a case study from the Statfjord Field. SPE Formation Damage Control Conference, Lafayette, Louisiana, 10.
4. **Harter T., 2003.** Water Well Design and Construction. References, The Regents of the University of California, Division of Agriculture and Natural Resources, Publication 8086, FWQP Sheet 11.3, 6.
5. **Nathaniel R., Warner N.R., Levy J., Harpp K. F., 2008.** Drinking water quality in Nepal's Kathmandu Valley: a survey and assessment of selected controlling site characteristics. Hydrogeology Journal, Vol. 16, Issue 2, 321-334.
6. **Kayastha K.P., 2015.** Skvjhiny s graviinontichnym filtrom ushirennogo kontura [Bell type Water Well with wide gravel filter pack]. National University of Water Management and Nature Resources Use, Rivne, Ukraine,



- Visnik. Collection of scientific-research work, Series 1(69), 33-49 (in Russian).
7. **Smirnov V.M., Golovan V.P., Lukyanenko V.C., 2012.** Specialne kivshove burilne obladannya z rozdilnym obertannym rizalnykh chasten ta vidchetrovym razvontajhennym nakopichuvacha. [Special bucket drilling equipment with separate rotational cutting parts and the centrifugal collectors]. *Girniči, budivelni, dorozni ta meliorativni mašini* [Mining, constructional, road and melioration machines], Nr79, 83-86. (in Russian).
  8. **Smirnov V.M., Golovan V.P., Konopat O.P., 2011.** Rozrobotka ta viznachena konstruktivnykh parametriv spechialnogo burilnogo ladannya dlya roboty v skladnykh gruntakh. [The development and definition of the design parameters of special drilling equipment for the complex rocks]. *Girniči, budivelni, dorozni ta meliorativni mašini* [Mining, constructional, road and melioration machines], Nr77, 71-76. (in Russian).
  9. **Salman M. A., 1999.** Groundwater: Legal and Policy Perspectives. World Bank Publications, Proceedings of a World Bank Seminar, Vol. 23-456, 262.
  10. **Bhandari H., Pandey S., 2006.** Economics of Groundwater Irrigation in Nepal: Some Farm-Level Evidences. *Journal of Agricultural and Applied Economics*, Vol. 38, Issue 01, 185-199.
  11. **Scott C.A., Sharma B., 2009.** Energy supply and the expansion of groundwater irrigation in the Indus Ganges Basin. *International Journal of River Basin Management*, Vol. 7, Issue 2, 119-124.
  12. **Guriovich A.D., Barymov E.B., 1982.** Obezhelezivanie vody v vodonosnykh plastakh. Deironing of water in the aquifer.. *Jhilishno kommunalmnoe khazyastvo. Housing and Communal Economy*, Minsk, Nr 6, 4 (18-19). (in Russian).
  13. **Siwiec T., Troińska J., 2007.** The influence of backwashing methods on the initial effluent quality during deironing of water, *EJPAU* 10(2), 16
  14. **Wang H.F., Anderson M.P., 1982.** Introduction to Groundwater Modeling: Finite Difference and Finite Element Methods. Academic press Inc. 237.
  15. **Filchakov L.F., 1959.** O modelirovanii osesimetricznykh potencialnykh polei na elektroprovodnoi bumage. Modeling of axis symmetric potential field on the electric conductive paper. *DAS (DAH) USSR*, 5 (in Russian).
  16. **Filchakov L.F., Panchishin V.I., 1961.** Integratory EGDA, Modelirovanie potencialnykh polei na elektroprovodnoi bumage. Integrating Electrical modeling of potential fields on an electric conductive paper. Kiev, Publishing House of Ukraine Academy of Sciences, 172. (in Russian).
  17. **Murthy Kasi M., Chi Y., Padmanabhan G., 2013.** Integrating Electrical Analogy and Computer Modeling of Groundwater Flow for Teaching Flow net Concepts. *International Journal of Engineering Pedagogy*, Vol 3, Nr 4 (39-46)
  18. **Voloshkinav O., Bereznitska J., 2014.** Development of Ukraine Territory Flooding processes: Its parameters and the influence on the environmental Safety level. *Motrol. Commission of Motorization and Energetics in Agriculture*, Vol. 16, Nr 8, 127-135.

РАЗВИТИЕ СКВАЖИНЫ С  
ГРАВИЙНО-ЗОНТИЧНЫМ  
ФИЛЬТРОМ УШИРЕННОГО  
КОНТУРА

**Аннотация.** Представлен новый тип водозаборной скважины с гравийно-зонтичным фильтром уширенного контура. Проведены исследования с использованием физического и электрического моделирования, а так же в полевых условиях. Найдены оптимальные физические параметры конструкций. Введены аналитические (эмпирические) формулы для расчёта гидравлических параметров, представлены рекомендации по применению скважин с гравийно-зонтичным фильтром уширенного контура.

**Ключевые слова:** электрическое и физическое моделирование скважин, водозаборные скважины, подземные воды, гравийно-зонтичный фильтр, водоснабжение, орошение.



## **Proposals to increase of economics effects of land-use residential and public buildings on the example of Kyiv**

*Mykola Malashevskiy, Polina Berova, Yuriy Mosiyehuk*

Kyiv National University of Construction and Architecture  
Povitroflotskyy prosp., 31, Kyiv, Ukraine, 03680,  
e-mail: nikolaymal@ukr.net, polinaberova@ukr.net, arba111@ukr.net

**Summary.** The article considers the current state of land-use in Kyiv. Considerable part of almost all the city's functional areas is used inefficiently. To improve the economic efficiency of their exploitation, we propose an optimizing variant of land-use of residential and public developments by allocation of excess of residential territories. This will provide an opportunity to attract those land plots at auctions to increase revenues to the State and Local Budgets of Ukraine.

**Key words:** land tax, land lease, houses adjoining, excess territories, investments.

sources are characterized as weak and inaccurate.

### **PURPOSE OF WORK**

Review the mechanisms of filling the State and Local budgets of Ukraine by improving the efficiency of exploitation of built-up territories in current land market terms on the example of Kyiv.

### **INTRODUCTION**

Now, the land market of Ukraine is in its formative stage. As the capital of the country and the most economically strong city of Ukraine Kyiv takes the leading position in development of the market. Implementation of transparent mechanisms for searching and optimization of land resources can greatly stabilize economic reforms in the country [11]. The State can significantly influence the economy by tax regulation, changing the amount of tax revenues, tax rates, tax forms and methods. One way of filling the State and Local Budgets of Ukraine is selling land and (or) rights at land auctions. Therefore, the problem of finding available land spots on the territory of largest cities in Ukraine is particularly relevant, because territorial

### **THE MAIN MATERIAL**

According to the proposal "Development Strategy of Kyiv till 2025", the capital of Ukraine will be developed the existing limits as a compact city. The analysis showed that the number of free land plots suitable for future development of the city, are very limited [3].

At the territory of Kyiv are defined main functional areas: public, residential and recreational zones, transport and engineering infrastructure, commercial and industrial zones, manufacturing, municipal services and special zones, operational areas, etc. Considerable part of city's functional areas is used inefficiently.

The volume of local resources is determined by necessity for residential and public facilities, hospitals and educational buildings,

shopping and entertainment malls, business buildings, hotels, sports complexes and other types of public buildings and for solving traffic problems at some districts, construction and reconstruction of streets network, road junctions, fire stations and other facilities. More effective exploitation of built-up territories can be resources for future development [4, 10].

Consider the options of improving economic efficiency of land-use residential high-rise buildings. According to urban settlements of regulatory areas of residential territories there are always neighborhoods excess (backup areas) adjoining to apartment buildings. Excess territory may be in districts where planned construction and (or) land improvements have not been implemented eventually [9, 20]. The volume of excess territories at residential districts or groups of high-rise buildings is determined by the difference of values – actual area of residential purpose, without area of buildings and regulatory square, required to existing residential buildings to meet the requirements of existing state building norms [18, 21, 23].

Excess territories can be used for new construction of different functions, if the area of excess territories and urban conditions and restrictions permit to do so [11]. Further such land plots can be formed as real estate properties and they or rights to them to be sold on a competitive basis. At the moment one of the most important tasks for Kyiv is to improve its investments attractiveness and first of all for capital investments. They provide real development of the territories and should have a significant multiplier effects on overall economic activity.

Capital investments are essential for urban development - the evolution of its social, industrial, engineering, transport and environmental infrastructure. In its turn, the level of infrastructure of the territories is an important determinant of investment attractiveness of the city in general and in its individual parts.

Price formation of urban land market is occurs under the influence by many factors: economic, social, political, cultural, govern-

ing the behavior of market participants and significantly affect the price level of supply and demand. However, a crucial role in the differentiation of prices for land in the city will play the following urban factors:

- transportation accessibility (accessibility to downtown, business centers, community centers, places of residence, public entertainment,
- the level of engineering equipment area,
- its historical, cultural and natural landscape value,
- environmental condition,
- socio-economic progress [4].

In other words, those factors in their totality determine the value of the urban territory of separate districts of the city.

In the following years the capital of Ukraine will develop more social, business and commercial buildings. This process will occur by increasing the level of business activity in the city due to mastering of new urban territories and intensification of existing areas.

The most attractive for investments are the following areas:

1. Citywide public and business centers created in places of concentration of public, business and commercial activities by the main city arteries.
2. Multipurpose community facilities that include public facilities - shopping, cultural, entertainment, offices and hotels, sports, etc.
3. Industrial and social complexes, that are created typically in areas of outdated and inefficient industries and are conglomerates of social, commercial and business establishments, industrial and warehousing (logistics) companies with high economic efficiency (so called Technopark) .
4. Recreation and community facilities that are created within nature conservation complexes and recreational facilities.
5. Detached investment attractive objects of perspective construction are placed usually on relatively small land plots within the existing residential, public, industrial and warehouse area:

- retail outlets, consumer services and catering,
- hotels, offices,
- facilities of culture, science and education,
- facilities of medicine, physical culture and sports,
- warehouse, transport companies [4].

Now consider the dynamics of land lease relationships in Kiev. In the city the first lease land contract was registered in 1994. As of 01.14.2010 there were 7430 lease agreements registered. Dynamics of lease contracts, acquire land lease rights and revenues from rent at 2008–2014 (Table 1).

At the end of 2014 revenues from land rent reached up to 1250 million hrivnya.

In total revenues from land use, payments for land lease increased from 60% in 2008 to 66% in September 2014.

One of the limiting factors for growth of concluded land lease agreements and revenues to the city budget is loopholes in legislation. That makes it possible to take the land for the permanent use and pay land tax of 1% of the normative monetary value of the land, whereas under the current Land Code each tenant (exclude enterprises, institutions, organizations, state and municipal ownership, organizations of disabled people and religious organizations) should use the land spots on lease by paying rent, which at least three times larger than the land tax [1, 20].

In accordance with economic-planning zoning, land spot is included in the 34<sup>th</sup> economic-planning zone, where the base cost of 1 sq.m. land is 632,71 hrivnya. The coefficient on the functional use of land spot accepted at 2,50 (land commercial use).

The land spot is not provided by:

- Central heating – 0,95,
- gas supply – 0,95.

Synthesis local coefficient  $C_{ls}$  equal to:

$$C_{ls} = 0,95 \cdot 0,95 = 0,90.$$

The land spot area is –1 708 sq.m.

Accordingly, monetary valuation  $V_n$  of the land spot with the peculiarities of the location of land within the economic-planning zone is, UAH:

$$V_n = 1708 \cdot 632,71 \cdot 2,50 \cdot 0,90 \cdot 1,028 \times \\ \times 1,152 \cdot 1,059 \cdot 1,2 = 3808\,720,25.$$

The position of land legislation to sell plots of state and municipal property including business entities for development is that such a sale should occur only on a competitive basis, via the procedure of land auctions. The only case where the law allows not to conduct auctions, is ransom of land for real estate owners of these objects ch. 2, Art. 127 and Art. 134 Land Code of Ukraine [13].

Sale of land of state and municipal property to citizens and legal entities on a com-

**Table 1**

Period (years)	Land lease agreements concluded in the period		Proceeds from the land tax on leases, mln. UAH		Proceeds of rent of the total revenues from the land tax,%
	Quantity, pcs.	Land area, ha	actual	planned	
2008	698	1315,66	934,3	200,0	62,95
2009	772	1215,40	1063	230,0	60,0
2010	674	1072,43	1137	260,0	60,6
2011	379	230,06	1124,48	290,0	60,0
2012	218	216,93	1195,40	320,0	60,0
2013	166	152,90	1140,40	305,0	60,0
2014	168	174,10	1250,90	420,0	66,0

petitive basis (auctions, competitions), except for land plots on which facilities of real estate owned by the buyers of these sites. Sale of land plots of state or municipal property can also be made to foreign countries and foreign legal entities [4, art.129]. Sale of land to foreign countries and foreign legal entities is carried out by the respective counsels in consultation with the Cabinet of Ministers of Ukraine and may be subject to registration in a foreign entity permanent establishment of the right of doing business in Ukraine.

The introduction of competitive methods of selling vacant land plots has clear advantages for the local community since successfully conducted land auctions are an effective way to significantly increase local revenues. Practice shows that the presence of competition between buyers, the sale price exceeds land auction starting price by several times.

According to the Department of Land Resources during the period 2003–2014 years statistic of land plots sale at auction in Kyiv is as follows: 2003 sold 3 land plots with total area of 2,3231 hectares in the amount of UAH 10 306 482,19 in aggregate starting price of 9 545 482,19 UAH on purpose: 1. car wash, service station, 2. trade center, 3. production facilities. 2004 sold 3 land plots with total area of 0,4189 hectares in the amount of UAH 2 435 925 in aggregate starting price of 1 755 925 UAH on purpose: 1. construction and operation of the plant and vehicle maintenance, 2. a house, 3. construction and operation of a residential building with infrastructure Facilities, centers of retail and catering. 2005 sold 4 land plots with total area of 0,848 hectares in the amount of 5 944 531,98 UAH in the aggregate starting price of 3 584 531,98 UAH purpose: 1. for construction and operation of the administrative office building, 2. for construction and operation on the Facilities of trade and services, 3. construction and operation of retail and office center, 4. construction and operation of a commercial complex. 2006 sold 1 land area of 0,3 ha 5 028 091,11 UAH with a starting price of 1 248 091,11 UAH earmarked for construction and operation of retail and office center. 2007 sold 3

land plots with total area of 113,6251 hectares in the amount of 1 001 578,032 UAH aggregate at a starting price of 869 994 066,9 UAH on purpose: 1. for construction and operation of retail and catering, 2. construction, operation and maintenance of retail and catering, 3. for construction, operation and maintenance of residential houses and about Facilities of social and cultural purposes. 2014 sold 1 land plot area of 0,0788 ha for 2 000 377,75 UAH with a starting price of 1 143 073 UAH earmarked for construction and operation and maintenance service stations or car washes.

Procedure of monetary valuation provides a comprehensive analysis of land plots contained in the databases of state land cadastre. In the process of monetary evaluation used data: location of land plot, its area (square), configuration and spatial orientation; nature of the relief of the plot; levels of construction and land improvement; qualitative characteristics of soils; pollution level and noisiness; distance to the center of the city, transport links, etc. Of particular importance in the implementation of monetary valuation has information about the purpose of the land plot, the actual functional use, legal status, including information about the ownership, use (including leasehold), mortgages, easements, prohibitions on alienation, encumbrance and other restrictions on rights regulations and land use [2, 5, 6, 7, 14].

As the most effective use of land plot in Shevchenko district of Kyiv accept the placement of office center [22].

To make an objective assessment and taking into account the information collected, method for the land balance is used.

*Balance method for land plots:*

After analyzing of 4 selected offers lease rates for office space are calculated from the average of which is 157,50 UAH. And average value excluding VAT (20%) which is 131,25 UAH.

To calculate the revenue forecast to lease office space 2765,44 sq.m.

1. Gross income  $I_g$ , UAH:

$$I_g = 131,25 \cdot 2765,44 \cdot 12 \cdot 0,95 = 4137\,789,6.$$

2. The annual operating expenses  $E_o$  include administrative expenses, maintenance and land tax.

Due to the fact that the premises have a large area and are leased to multiple business entities, in the management part property owners must have a manager, accountant, guards and cleaners.

The annual cost of managing the planned property equal to 252 000 UAH.

For buildings located on the land plots, the annual cost of routine maintenance  $C_{rm}$ , (UAH/year) indexed on the valuation date, is:

$$C_{rm} = 86 \cdot 2,34 \cdot 1,08 \cdot 3456,8 = 751\,298,15.$$

General operating expenses  $E_{og}$  are, UAH/year:

$$E_{og} = 252\,000 + 30\,494,29 + 751\,298,15 = 1\,033\,792,44.$$

3. Net operating income  $I_o$ , UAH:

$$I_o = 4137\,789,6 - 1\,033\,792,44 = 3\,103\,997,16.$$

4. The rate of capitalization  $R_c$ :

$$By\,1\,sq.m = 3\,102\,997,16 / 2\,765,44 = 1\,122,42$$

2 765,44 – area of office premises leased, sq.m.

$$R_c = 1122,42 / 11669,79 \cdot 100 = 9,6\%$$

5. Capitalized net operating income  $NOI$ , UAH:

$$NOI = 3\,103\,997,16 / 9,6 \cdot 100 = 32\,333\,303,75.$$

6. The cost of land improvements: the cost of land allocation and production of documents  $C_i$  [17] are based on estimates for land surveying work and equal to 50 000 UAH (excluding VAT).

The cost of buildings  $C_b$  on 1 sq.m. is 9 041 UAH inc. VAT (7 534,17 UAH VAT excluded), UAH:

$$C_b = 7534,17 \cdot 3456,8 = 26044118,86$$

where total expenditure on pay equity is 1 825 190,40 UAH.

An investor expects to receive a return on invested capital while investing in any business including construction [5]. In a market economy actual earnings relates more to the company's trade secrets, so it is too difficult to determine the level of income that may be considered typical for any variant of construction. But features of doing business in Ukraine provide a high level of profitability.

Due to the lack of reliable information on rate of return of investors, appraisers consider possible investors to take profits at some minimal profit, which encourages investors to invest in the facilities to measure up to a bank deposit rate. Investing in building seeks to profit no less than what investors could get when placing funds on deposit of leading banks in Ukraine.

An investor's income has been taken as 15,8% of the total cost of land improvements  $C_{il}$ , UAH:

$$C_{il} = (50\,000 + 20\,835\,295,09 + 1\,825\,190,40) \cdot 15,8 / 100 = 3\,588\,256,7.$$

If we consider the building process as a business option, this option can be predicted as some typical profit developer, which in this case is taken into account in the estimated cost of the facility, which is designed above the text.

In some cases development of conditional large-scale facilities assumes the appropriate credits, but the cost of credits seriously varies and depends on several factors (policy of a financial institution, the history of relationship with the borrower, risks of project loans, etc.), moreover consideration the value of credit resources requires determination of weight of the credit in development costs that must be justified. That is why forecasting the

cost of financing for the purposes of this assessment was not carried out. Today lend to business in Ukraine is about 20-25%, which is uneconomical for developers. Given the above construction financing costs are not counted.

Determine the total cost of land improvements  $C_i$ , UAH:

$$C_i = 50\,000 + 20\,835\,295,09 + 1825\,190,40 + 3\,588\,256,71 = 26\,298\,742,20.$$

7. The cost of land plot  $C_{lp}$ , UAH:

$$C_{lp} = 32333\,303,75 - 26\,298\,742,20 = 6\,034\,561,55.$$

If we consider an investor as a buyer of real estate, the key issue for him is a business that is better to invest and how profitable.

When an investor buys a property in form of building or structure, the question is what is better to do with land: buy or rent it when an investor has its own funds.

Calculate the feasibility of redemption a land plot on the example a land plot located in the Shevchenko district of Kyiv. To buy the land plot is necessary to take a bank loan in the amount of 6034 562,00 UAH. The average lending rate of commercial banks in Ukraine for businesses is 20%. At the annual loan repayments the investor can spend 50% of income, ie 1 551 998,58 UAH. To determine how many years borrower will repay the loan we will apply the following formula:

$$n = \log_{(1-r)} \frac{a}{a - PV \cdot r}, \quad (1)$$

where:  $a$  – annuity equal payments or contributions are made with the same frequency,  $PV$  – the present value of the loan,  $r$  – interest rate,  $n$  – the number of charges (years). Thus, under these conditions, the loan can be paid over 8 years. The amount spent on the credit is equal to 12 415 988,64 UAH.

To calculate the rent it is necessary to multiply rental rate by the regulatory mone-

tary value of land plot [8, 12]. The rental rate for the property is 10% from the normative assessment  $3\,808\,720,25 \cdot 10\% = 380\,872,03$  UAH/year.

If the amount which spent on loan to share the rent rate, we'll find out how long the land plot can be rented for these funds, years:

$$12\,415\,988,64 / 380\,872,03 = 32.$$

To find out what option will bring more profit, we'll use the following formula:

In case of buying land, the income will be over 32 years, UAH:

$$8(3103997,1 - 1551998,5) + 8 \cdot 3103997,1 = 37\,247\,965,92.$$

In case of renting land for 32 years, the income at the end of the period will be equal to, UAH:

$$32(3103997,16 - 380872,03) = 87\,140\,004,16.$$

On the example is set that for buying a land plot, a bank loan must be taken out in the amount of 6 034 562,00 UAH. The average lending rate of commercial banks in Ukraine for businesses is 20%. At the annual repayment investor can spend 50% of income, ie 1 551 998,58 UAH.

After calculations for loan repayment requires 8 years, and if the rent, then after 32 years of activity will profit more if rented land. This means that land leasing is more profitable option for investors.

## CONCLUSIONS

1. Proposed mechanisms of search and optimization of land resources on the example of Kiev will largely can stabilize State transformations that are associated with the transition to market-based forms of management.

2. Selecting of excess adjoining acreage of residential areas and forming them as fa-



cilities of immovable property, will involve them for sale on a competitive basis.

3. The introduction of competitive ways of selling vacant land plots has undeniable advantages for the local community, since successfully conducted land auctions are an effective way to significantly increase revenues to local budgets.

#### REFERENCES

1. **Calinescu T., 2010.** Moral aspects of modernization the tax policy in the conditions of existence the depressed territories. TEKA: kom. Mot. Energ. Roln., OL PAN, vol. XA, 57-63.
2. **Dehtyarenko Y.F., Lyhohrud M.G., Mantsevych Y.M., Palyeha Y.M., 2007.** Methodological foundations of monetary valuation of land in Ukraine, Kyiv, 624. (in Ukraine).
3. **Development Strategy of Kyiv till 2025, 2011.** (in Ukraine).
4. **General Plan of the city of Kyiv, 2002.** ME «Institute of the General Plan of Kyiv». (in Ukraine).
5. **Harrison H., 1994.** Estimation. RIO Mo-sobluprpolihrafvydav, 231. (in Ukraine).
6. **Methodology** expert money assessment of land, approved by the Cabinet of Ministers of Ukraine "On expert valuation of land", from **11.10.2002.** No 1531. (in Ukraine).
7. **Procedure** for expert money assessment of land, approved by the State Committee for Land Resources of Ukraine "On approval of expert money estimation of land" from 09.01.2003 2 and registered by the Ministry of Justice of Ukraine on **23.05.2003.** No 396/7717. (in Ukraine).
8. **Procedure** of normative evaluation of agricultural land and settlements (registered by Ministry of Justice of Ukraine on **05.04.2006** №388/12262). (in Ukraine).
9. **Program** of land use and protection in Kyiv for 2011-2015, **2002.**
10. **Prusov D., Badah V., 2013.** Principles for municipal facilities reconstruction based stability assessment methodology. Motrol: kom. Mot. Energ. Roln., OL PAN, Vol. 15\_5, 31-35.
11. **Sulima-Samuylo G.D., Malashevskiy M.A., Mosiychuk Y.A., Berova P.I., 2014.** Kyiv National University of Construction and Architecture. Approaches for taxation of excess land territories of housing development. Urban and territory planning: scientific-technical digest. Kyiv, KNUCA, Nr 53. (in Ukraine).
12. **The decision** of the Kyiv City Council. **26.07.2007.** No 43/1877(add No 2) "On approval of technical documentation for regulatory monetary value of land in Kyiv and the Order of the definition". (in Ukraine).
13. **The Land Code of Ukraine, Revision of 12.03.2015.** (in Ukraine).
14. **The Law** of Ukraine "On the assessment of property, property rights and professional valuation activities in Ukraine". **12.07.2001.** No 2658-III. (in Ukraine).
15. **The Law** of Ukraine «on investment activity». **18.09.1991.** No 1560-XII. (in Ukraine).
16. **The National Standard** "General Principles of Property Valuation and Property Rights" approved by the Cabinet of Ministers of Ukraine. **10.09.2003.** No 1440. (in Ukraine).
17. **The National Standard, 2013.** NSTU-N B B.2.2-9:2013 Guidance on the allotment of districts territories (city blocks) to determine the areas surrounding apartment buildings. (in Ukraine).
18. **The National Standard, 28.10.2004.** Real Estate Valuation. Approved by the Cabinet of Ministers of Ukraine, No 1442. (in Ukraine).
19. **The rules** of professional appraiser, approved by the Ukrainian Society of Appraisers. **4.11.1995.** Protocol No 7. (in Ukraine).
20. **The Tax Code of Ukraine, Revision of 01.04.2015.** (in Ukraine).
21. **Tuzova L.I., Berova P.I., 2013.** Peculiarities of application methodical approaches concerning allotment of districts territories (city blocks) in different urban conditions. Urban and territory planning: scientific-technical digest. Kyiv, KNUCA, Issue No 47. (in Ukraine).
22. **Ukrainian** qualifier of the target land use, approved by the State Committee for Land Resources of Ukraine on **24.04.1998.** (in Ukraine).
23. **Urban** planning. Planning and development of urban and rural settlements. State building standards SBS 360-92\*\*. **2002.** Kyiv, Architecture and housing policy of Ukraine. (in Ukraine).

ПРЕДЛОЖЕНИЯ ПО УВЕЛИЧЕНИЮ  
ЭКОНОМИЧЕСКОГО ЭФФЕКТА  
ОТ ИСПОЛЬЗОВАНИЯ ЗЕМЕЛЬ ЖИЛОЙ И  
ОБЩЕСТВЕННОЙ ЗАСТРОЙКИ НА ПРИ-  
МЕРЕ ГОРОДА КИЕВА

**Аннотация.** В статье рассмотрено нынешнее состояние использования земель города Киева. Значительное количество территорий практически всех функциональных зон города используется неэффективно. Предложен вариант оптимизации землепользования жилой и общественной застройки с вычлене-

нием сверхнормативных площадей жилых территорий и повышением экономической эффективности их использования, что даст возможность включить их в оборот земель на конкурентных основаниях. Это, в свою очередь, позволит увеличить размер поступлений в соответствующие бюджеты государства.

**Ключевые слова:** земельный налог, арендная плата, придомовая территория, сверхнормативная площадь, инвестиции.

## The role of land compulsory purchase in engineering and transport infrastructure development

*Olga Petrakovska, Mariia Mykhalova*

Kyiv National University of Construction and Architecture  
Povitroflotskyi av., 31, Kyiv, Ukraine, 03680, e-mail: petrakovskaolga@gmail.com

**Summary.** This paper deals the consideration of the consequences of unjustified decision making on the land development with the application of land compulsory purchase for the engineering and transport infrastructure construction. In the article are considered the approaches to determine the efficiency of land development from the standpoint of needs of population life support and industry complex as well as investment interests.

**Key words:** social efficiency, economic efficiency, transport and engineering infrastructure, land development, land compulsory purchase.

### INTRODUCTION

In the terms of active integration of Ukraine into the world community special importance is given to sustainable development of economic relations. Integration with the Western European countries leads to increasing of trade turnover and passenger transportation volume between the countries. Transit location of Ukraine is one of the most important factors of increasing the role of transport industry in the international economic activity.

Traffic flows plays significant role directly both in social and economic life of the population and in the economy of the country as a whole, as well as regions and the cities. The efficiency of such traffic flows directly depends on the development of engineering and transport infrastructure.

It should be noted that the majority of objects of engineering and transport infrastructure are the linear objects of great length. It is the reason of specific features of their construction and development. At the same time the traffic and engineering loading within settlements and outside their boundaries have fundamental differences. It is caused by the structural organization and functional differences of these areas [14,20].

The specific features of the construction of engineering and transport structures within settlements lay in necessity of their implementation into the existing urban planning structure of settlements which is characterized by complex anthropogenic conditions. It makes difficult to choose their locations [13].

The large number of restrictions in existing built environment requires searching of alternative variants of decisions which are legally permitted as well as socially and economically efficient within established limits.

Situation is somewhat different outside borders of settlements. There are no restrictions caused by the existing built environment and at first glance it seems that the infrastructure elements can be placed anywhere. But in this case there are limitations arising from the other reasons such as land quality, dispersion of settlements and nature resources etc.

Consequently speaking about the construction of new engineering structures should be stressed approach based on multiple-path analysis. Moreover the kind of land use and property rights should be assessed also. For example, a new road may be the shortest, but pass through the private lands with high prices or lands with special value. So, it is necessary to correctly model a decision which will determine the feasibility and efficiency of engineering and transport infrastructure construction.

### PURPOSE OF WORK

The purpose of the paper is a justification of the necessity of complex overview mainstreaming of consequences of land compulsory purchase in transport and engineering infrastructure construction.

### THE MAIN MATERIAL

Modern approaches to determine the efficiency of land development (*E gen*) should be based on sustainable development, taking into account two main components. First is directed to population life support and economy efficiency (*El.sup.*). The second being capital investments efficiency (*Ein.*) [8, 16].

Thus, the overall efficiency of land use can be expressed by the relation:

$$E_{gen} = f(El.sup.; Ein) \rightarrow \max. \quad (1)$$

From the standpoint of population life support and economy the land use efficiency is characterized by social and economic components with included implementation costs:

$$El.sup. = f(Esoc, Eec; COSTS), \quad (2)$$

where:

*Esoc* – social efficiency,  
*Eec* – economic efficiency,  
*COSTS* – land development costs.

Social efficiency reflects the immaterial production spheres, which are aimed to improve the population living conditions such as housing, health, medical and cultural services, etc. It can be evaluated for the whole country as well as for regions or cities [15].

Economic component of land use efficiency is directly related to local gross product and local budget revenues. Total income of local budgets consists of taxes, non-tax and other revenues on the irrevocable basis. Tax revenues, duties and other mandatory payments and their rates are legally provided [9, 18].

Non-tax revenues are from property and commercial income, administrative charges and payments, noncommercial sale income, fines and financial sanctions revenues, etc. [1, 12].

Economic efficiency from land use can be evaluated as a ratio of the sum of local budget revenues from land ownership and land tenure (INC) to the sum of overall land development costs (COSTS):

$$E_{ec} = \frac{\sum_{i=1}^n INC_i}{\sum_{k=1}^m COSTS_k}. \quad (3)$$

The article focuses on the study of the potential budget revenues on the basis of modeling the consequences of transport structures and utilities construction. Special emphasis is given to the problem of land use with different types of land rights.

The peculiarity of land resources as an object of management and development is the fact that they can not be additionally renewed unlike other natural resources [17]. This is the basis for the management decision-making. Some changes should be made for transformation process. For example, to change the land owner it is necessary to transfer the property rights. When changing land use, if we increase the residential area, the area of some other purposes should consequently decrease.

Any land use is characterized not only by legal and physical characteristics but also by kind of activity which conducted on it. The article deals with the following main kinds of the local budget revenues from:

- transfer of land ownership or land use;
- land ownership and land use charges;
- economic activity taxes;
- revenues from fines and financial sanctions for the improper land use [5,18].

Therefore, the sum of total incomes  $INC_i$  at the optimum land use will be as follows:

$$\begin{aligned} \sum_{i=1}^n INC &= \sum_{i=1}^c INC_{tax.tran} .i + \\ &+ \sum_{i=1}^a INC_{Sown.use} .i + \\ &+ \sum_{i=1}^z INC_{prof.ec.act} .i + \sum_{i=1}^e INC_{fines} .i \end{aligned} \quad (4)$$

where:

$INC_{tax.tran}$  – tax income when transferring land ownership or land use,

$c$  – the number of land plots on which rights are transferred,

$INC_{own,use}$  – land ownership or land use incomes,

$a$  – the number of tax payable land plots;

$INC_{prof.ec.act}$  – income from taxes on the profit from economic activities,

$z$  – the number of businesses liable to pay a tax profit to the local budget,

$INC_{fines}$  – revenues from fines for violation of the legislation or negative consequences of land use,

$e$  – the number of land plots owners of which pay fines or other charges for violation of the legislation or the negative consequences of land use.

Income from the transfer of land title basically consists of the sale of ownership or use right. Income depends on the type of ownership [3].

When transferring private property rights, basic income consists of revenues paid at registration of contract of rent or sale. The

income contains the state duty and tax on income received from the sale of real estate [3, 7, 18].

When transferring state or municipal property rights, basic income is generated on the auction sale. The purchase basis being market value dependable on market conditions and on demand on land plots of certain urban value.

Income from land ownership and land use contains the taxes on land and land use payment. The taxes are determined by the property costs. And property's cost depends on its location and type of use [4].

Income from taxes on economic activities is considered in connection with their increase due to the optimal use of the land plot in the existing urban planning environment.

For example, the owners of retail real estate located in places of daytime population concentration have the potential possibility to obtain more income than the owners of plots with complicated transport access. As a result, the optimal location of the land plot in accordance with its function can assist of profits increase and consequently increasing revenues to the local budget.

In case of violations, the legislation sets scheme of prosecution and bringing to responsibility by system of paying the fines. Implementation of really effective methods of punishment, sanctions and fines for violation of the legislation will encourage compliance with law and as consequence the inflow in local budget. It can provide additional profitable opportunities in urban infrastructure development. In both cases, the results are both for the operation and development of the whole city and also for every resident.

Let's consider the costs component in the formula (2).

Land development costs of settlements include construction costs of necessary residential and industrial objects purpose, namely: objects of social infrastructure, objects of residential real estate, public service objects, objects of industry, objects of engineering and transport infrastructure, etc.

Therefore, the sum of total implementation costs of land development could be expressed the following way:

$$\sum_{k=1}^m COSTS_k = \sum_{i=1}^z COSTS_{res}_z + \sum_{i=1}^l COSTS_{soc}_l + \sum_{i=1}^c COSTS_{ser}_c + \sum_{i=1}^u COSTS_{ind}_p + \sum_{i=1}^s COSTS_{inf}_s \quad (5)$$

where:

$COSTS_{res}$  – costs of construction of residential real estate objects (houses, cottages, hotels etc.),

$z$  – the number of the residential real estate objects,

$COSTS_{soc}$  – costs of construction of social infrastructure objects (schools, hospitals, stadiums etc.)

$l$  – the number of the social infrastructure objects,

$COSTS_{ser}$  – costs of construction of public service objects ,

$c$  – the number of public service objects;

$COSTS_{ind}$  – costs of industrial construction,

$u$  – the amount of the industrial objects,

$COSTS_{inf}$  . – costs of engineering and transport infrastructure construction,

$s$  – the number of the engineering and transport infrastructure objects.

The objects of engineering and transport infrastructure should be considered in 2 directions:

- as a significant component of land development,
- as the planning object.

It's very difficult to exaggerate the importance of the construction of abovementioned objects. Actually, construction object that is not equipped with modern engineering facilities don't meet the standards and requirements of the market.

Transport accessibility of objects provides communication with employees, suppliers and customers. So, actually any structure which is not connected to utility networks is

'dead'. A lack of transport connections leads to social and economic isolation of the structure.

Different objects require various engineering and transport service. For example, for residential real estate it is necessary to provide them with water supply, sewerage systems, heating etc. for domestic use. While industrial objects require more powerful engineering systems, which are determined by production technology.

Firstly, the specific feature of engineering and transport infrastructure objects as part of the planning structure is that they pass through cities, regions and even countries.

The engineering and transport infrastructure objects are very versatile. Many of them have different kind of negative effect on environment (road, airport, port). But there are some objects that need to be protected from anthropogenic impacts (water supply objects). In both cases, it requires additional area to arrange buffer zones [2,19].

Unlike detached object, engineering and transport infrastructure construction needs land compulsory purchase because of great length and large areas which they cover. Compulsory purchase can be applied to forest lands, agriculture land as well as in built-up areas [6].

Within settlements compulsory purchase is often due to the lack of free areas for city development. Outside the settlements majority of lands are in long term rent and in private ownership.

When city development is planned on the land of private property, for construction of engineering and transport infrastructure the land can be voluntary sold and by use compulsory purchased. Land plots are in private property and land purchase is effected with the consent of its owner or through a court proceeding in accordance with the market value [6, 11]. In the case of a court proceeding local community has to compensate for damages, including lost profits, damages from the temporary occupation of land plots, land degradation; damages due to lost revenues and also when existing use became worse or impossible [11].

Therefore we think it is necessary to consider total amount of construction costs for the engineering and transport infrastructure accounting the necessity of purchase land plots from land owners and users.

The sum of total construction costs for engineering and transport infrastructure objects could be expressed as follows:

$$\begin{aligned} \sum_{i=1}^s \text{COSTS}_{inf_s} &= \sum_{i=1}^r \text{COSTS}_{com.pur.r} + \\ &+ \sum_{i=1}^x \text{COSTS}_{pr.des.x} + \\ &+ \sum_{i=1}^p \text{COSTS}_{comp.dam.p} + \\ &+ \sum_{i=1}^t \text{COSTS}_{const.t}, \end{aligned} \quad (6)$$

where:

$\text{COSTS}_{com.pur.}$  – costs for compulsory purchase of land (when necessary),

$r$  – the number of land plots that are subject of full or partial purchase,

$\text{COSTS}_{pr.des}$  – costs of purchase of the rights to development and project design costs,

$x$  – the number of objects which need the permission and project design development,

$\text{COSTS}_{comp.dam.}$  – the costs of compensation for damages to land plot's owners,

$p$  – the number of landowners and land users who should be paid compensation for the loss of lost revenues,

$\text{COSTS}_{const.}$  – construction costs,

$t$  – the number of objects for construction.

In the case of compulsory purchase of land for public needs total costs for land development are financed from the local budgets.

The costs of project design and construction costs depend on the scale of the object and market pricing conditions.

Let's focus our attention on the first two components of above formula that affect on the reduction of the local budget. As mentioned above the shortest way is not always

the best. At first glance it seems that the fewer land plots are to be purchased, the less will be the sum of total costs and as a result the less money spent from the local budget. But it is only at first glance.

Multiversion choice of route for the construction of future communication must take into account all the components of their future performance efficiency. Moreover increasing of the road length can make it possible to provide more objects in different kind of services, A similar situation can happen in the case of compensation payment.

Moreover the presence of road or engineering structures increases the potential attractiveness of these lands and their market value. In addition, it is necessary to mention about potential and possible improvement of the proximately engineering service to residents of remote villages. At the same time, it can have a positive impact on economic efficiency of industrial objects.

Local budget is filled both with real estate tax and land tax. Today in Ukraine there is no real estate, only land tax [18]. In turn, as soon as a real estate tax is being introduced, it will depend on the market value, as it is in majority European countries. The development of transport and engineering infrastructure objects will encourage local revenues by increasing the market value of the land.

The analysis of the consequences of unjustified construction of transportation and engineering network and as a result land compulsory purchase and land quality deterioration need special consideration.

Sometimes land compulsory purchase costs and compensation costs are equal or significantly higher than the common investment costs and have no visible economic and social effect. Present scheme neglects factors mentioned above.

According to the legally approved city planning documentation, the provision of necessary in areas is effected. Other words, design decision is coordinated without all necessary compensation costs. In any case, there are always serial alternative variations.

The costs for compulsory purchase should always be taken into consideration when estimating comprising these variants.

City planning documentation is the basis for the land compulsory purchase. The present land use in legal boundaries is necessary to take into account for reasonable decision-making when urban planning [6, 10].

When such aspects are missed, it is necessary to make changes of city planning documentation. Currently legislation identified two sources of financing city planning documentation: local budgets and investment funds. In most cases, these works are carried out by municipalities. It leads to local budget outflow.

Any chance to adopt unreasonable decisions can bring to new corruption schemes.

Taking into account all incomes and expenses formula (3) takes the following form:

$$Eec = \frac{\sum_{i=1}^c INCTax \cdot tran_i + \sum_{i=1}^a INCSown \cdot use_i}{\sum_{i=1}^r COSTScom \cdot pur \cdot r + \sum_{i=1}^x COSTSpr \cdot des \cdot x + \sum_{i=1}^z INCprof \cdot ec \cdot act \cdot i + \sum_{i=1}^e INCfines \cdot i} \longrightarrow \frac{\sum_{i=1}^p COSTScomp \cdot dam \cdot p + \sum_{i=1}^t COSTSconst \cdot t}{}$$

For commercial investment of any business entity the quality of land plot is assessed in terms of its transport accessibility and availability of all necessary engineering services for the planned activity.

Transport and engineering infrastructure development has direct effect not only on

population living standard and economic growth, but also on investment climate.

## CONCLUSIONS

The follow conclusions can be made:

1. Complex approach to land compulsory purchase method should be applied for effective decision-making.

2. If the comprehensive analysis and assessment of the impact of compulsory purchase is not applied, the outcomes can be as follows:

- overall costs for land development can be groundlessly increased;
- total investment attractiveness of land as a result of the construction is not commensurable with negative environmental impacts;
- the necessity to make changes to urban plans which are funded by the local budget can be appeared;
- the complication of bureaucratic coordination schemes encourages the creation and apply corruption schemes.

## REFERENCES

1. **Calinescu T., 2010.** Moral aspects of modernization the tax policy in the conditions of existence the depressed territories. TEKA: kom. Mot. Energ. Roln., OL PAN, Vol. XA, 57-63.
2. **Composition** and content of construction design documentation. State building standards SBS A.2.2.3-2012. (in Ukraine).
3. **Dehtyarenko Y.F., Lyhohrud M.G., Mantsevych Y.M., Palekha Y.M., 2007.** Methodological foundations of monetary valuation of land in Ukraine, Kyiv, 624. (in Ukraine).
4. **On approval of expert** money estimation of land. Procedure for expert money assessment of land, approved by the State Committee for Land Resources of Ukraine from 09.01.2003 and registered by the Ministry of Justice of Ukraine, **23.05.2003.** No 396/7717. (in Ukraine).
5. **On approval of the imposition** of penalties for violations in the field of urban development. Resolution of Cabinet of Ministers of Ukraine. **06.04.1995.** No 244. (in Ukraine).



6. **On Compulsory Purchase** of Land Plots and Property Located On Them in Private Ownership for the Social Needs and on the Grounds of Social Necessity. The Law of Ukraine, **17.11.2009**. No 1559-VI. (in Ukraine).
7. **On expert valuation** of land. Methodology expert money assessment of land, approved by the Cabinet of Ministers of Ukraine, **11.10.2002**. No 1531. (in Ukraine).
8. **On investment activity**. The Law of Ukraine, **18.09.1991**, No 1560-XII. (in Ukraine).
9. **On Local Government**. The Law of Ukraine, **21.05.1997**. No 280/97. (in Ukraine).
10. **On Regulation of urban activity**. The Law of Ukraine, **17.02.2011**. Nr 3038-VI. (in Ukraine).
11. **On the order** of compensation determination for damages to land owners and land users. Resolution of Cabinet of Ministers of Ukraine, **19.04.1993**. Nr 284. (in Ukraine).
12. **Petrakovska O., 2007**. The methodology of management of land use system at urban territory. Dissertation of the Dr. Sci. Tech. Kyiv, KNUCA, 270.
13. **Petrakovska O., Tatsii U., 2015**. Real Estate development and sustainable cities development. Kyiv, Ukraine, 504 (in Ukraine).
14. **Polischuk V., Lanovoy A., 2012**. Practical methods of efficiency evaluating of functioning and necessity in the road network development. Motrol: kom. Mot. Energ. Roln., OL PAN, Vol. 15, 69-78. (in Russian).
15. **Prusov D, Badakh V., 2013**. Principles of municipal facilities objects reconstruction on the basis of assessment methodology the grounds sustainability. Motrol: kom. Mot. Energ. Roln., OL PAN, Vol. 15, 31-35. (in Russian).
16. **The concept** of sustainable territory development. Resolution of Cabinet of Ministers of Ukraine, **24.12.1999**. No 1359-XIV. (in Ukraine).
17. **The Land Code** of Ukraine, Revision of **12.03.2015**. (in Ukraine).
18. **The Tax Code** of Ukraine, Revision of **01.04.2015**. (in Ukraine).
19. **The Water Code** of Ukraine, Revision of 28.12.2014 (in Ukraine).
20. **Urban planning**. Planning and development of urban and rural settlements. State building standards SBS 360-92\*\*, **2002**. Kyiv, Architecture and housing policy of Ukraine. (in Ukraine).

РОЛЬ ПРИНУДИТЕЛЬНОГО ИЗЪЯТИЯ  
ЗЕМЕЛЬ ПРИ СТРОИТЕЛЬСТВЕ  
ОБЪЕКТОВ ИНЖЕНЕРНОЙ И  
ТРАНСПОРТНОЙ ИНФРАСТРУКТУРЫ

**Аннотация.** В статье обоснована необходимость учета последствий от необоснованного принятия решений при развитии территорий с применением принудительного изъятия земельных участков для строительства объектов инженерно-транспортной инфраструктуры. Рассмотрены подходы к определению эффективности развития территорий с точки зрения обеспечения жизнедеятельности населения и нужд экономического комплекса, а также инвестиционных интересов.

**Ключевые слова:** социальная эффективность, экономическая эффективность, объекты инженерно-транспортной инфраструктуры, развитие территорий, принудительное изъятие.



## Ways of comfort radius definition of accessibility for pedestrians to the first service objects

Vladislav Golubenko

Kyiv National University Of Construction and Architecture  
Povitroflotskyy prosp., 31, Kyiv, Ukraine, 03680, e-mail: vllood@bk.ru

**Summary.** In this article is briefly exposed one of the main problem of civil construction of nowadays – accessibility of pedestrian areas. Were investigated normative documents of Ukraine connected with this question, were defined and classified main factors, that influence on the comfort of walker's move. Were also defined factors that are influencing on the planing aspect of comfort of the movement- pedestrian accessibility.

The given results of definition of the influence of such factors as type of attraction object, type of the layout of site development and dilatational slope of the track. The influence of the type of the priority service object was made with pedestrian audition. The grade of influence of the site development type was defined with misalignment coefficient, usual for several layout types of pedestrian tracks. The influence of longitude inclination is being defined through monitoring of the changes in cardiovascular system and inner body temperature during the movement with permanent speed on different slopes.as a result, was given a method of definition of the comfort of accessibility for pedestrians to the object of priority service, that can be used during the planing of new development and during the estimation of one already existing. According to achieved results, the comfort radius can be both smaller and bigger of the normative, that gives corresponding economical benefits with the usage of the method.

**Key words:** accessibility for pedestrians, radius, normative, type of site development, slope, pedestrian audition, misalignment coefficient.

## INTRODUCTION

Urban construction — one of the most important sciences of the modern urban society. The theory of urban construction is investigating the planning organization of displacement and populated places, peculiarities of theirs formation, functioning and development in correlation with socio- economic and natural conditions. In urban construction theory are being investigated regularities of formation and function of urban construction developments, are being developed principles and criteria of project decision making [20]. One of the main problem of urban construction is arrangement of pedestrian flow in residential area. Accessibility for pedestrians — is the factor that influences on the definition of people's living comfort, shopping, different objects visiting, rest and time passing on the territory [8].

## MATERIALS AND METHODS

In Ukraine accessibility for pedestrians is being regulated by the number or governing documents that have a long history. In 1955 in USSR were admitted several construction norms and rules – SNIP 2-V.1 “Laying-out of populated locality”[16], and in 1958 – SN 41-58 “Rules and norms of laying-out and site development of cities” [12], that com-

pleted the one published before [16] and was regulating the radius of accessibility for pedestrians of 500 meters to the majority of target places among people. After that, had appeared several legislating documents, that replaced the previous, in which was changing the radius of accessibility for pedestrians [17, 18, 19]. Finally, when Ukraine has got Independence, was adopted a document that is active nowadays – Governmental Building Codes DBN 360-92 [3].

The brief analysis [6] of accessibility for pedestrians radius changes in this documents, showed, that the majority of numbers stayed unchangeable from one to another document.

There are no proves of investigations that caused the admission of noted radiuses in area of accessibility for pedestrians in cities [12]. According to [13], they were determined by 5-minutes walking accessibility, but it can not be considered sufficient for the

arrangement of normative radius. Besides the growth of density of population, character of transport traffic and specificity of attraction points of last 50 years, the norms in [3] are basing on norms in [12]. They are presented in the table 1. Appears the necessity of its grounding or changeover.

There is a big amount of factors that are influencing on the accessibility for pedestrians and they have to be investigated and classified. There are several factors that are being defined as impact causers on accessibility for pedestrians: degree of street network transmissibility, land-use management, built-upends, trees and other plants presence, entrances and another element alongside front, visibility, free places presence around houses, that can be visited, urban design etc [5].

**Table 1.** Definition of attraction object type coefficient on the radius of accessibility for pedestrians to them

Attraction object	Normative radius of accessibility for pedestrians ( <i>m</i> )	Desirable radius of accessibility for pedestrians ( <i>m</i> )	Attraction object type influence coefficient
Kindergarten	300	600	2,00
School	750	800	1,07
Market	500	510	1,02
Workshop	500	640	1,28
Polyclinic	1000	810	0,81
Pharmacy	500	440	0,87
Sport	1500	850	0,57
Stops	500	350	0,70
Garages	1000	330	0,33
Parking	150	230	1,96
Bank	500	600	1,21
Post office	500	580	1,16

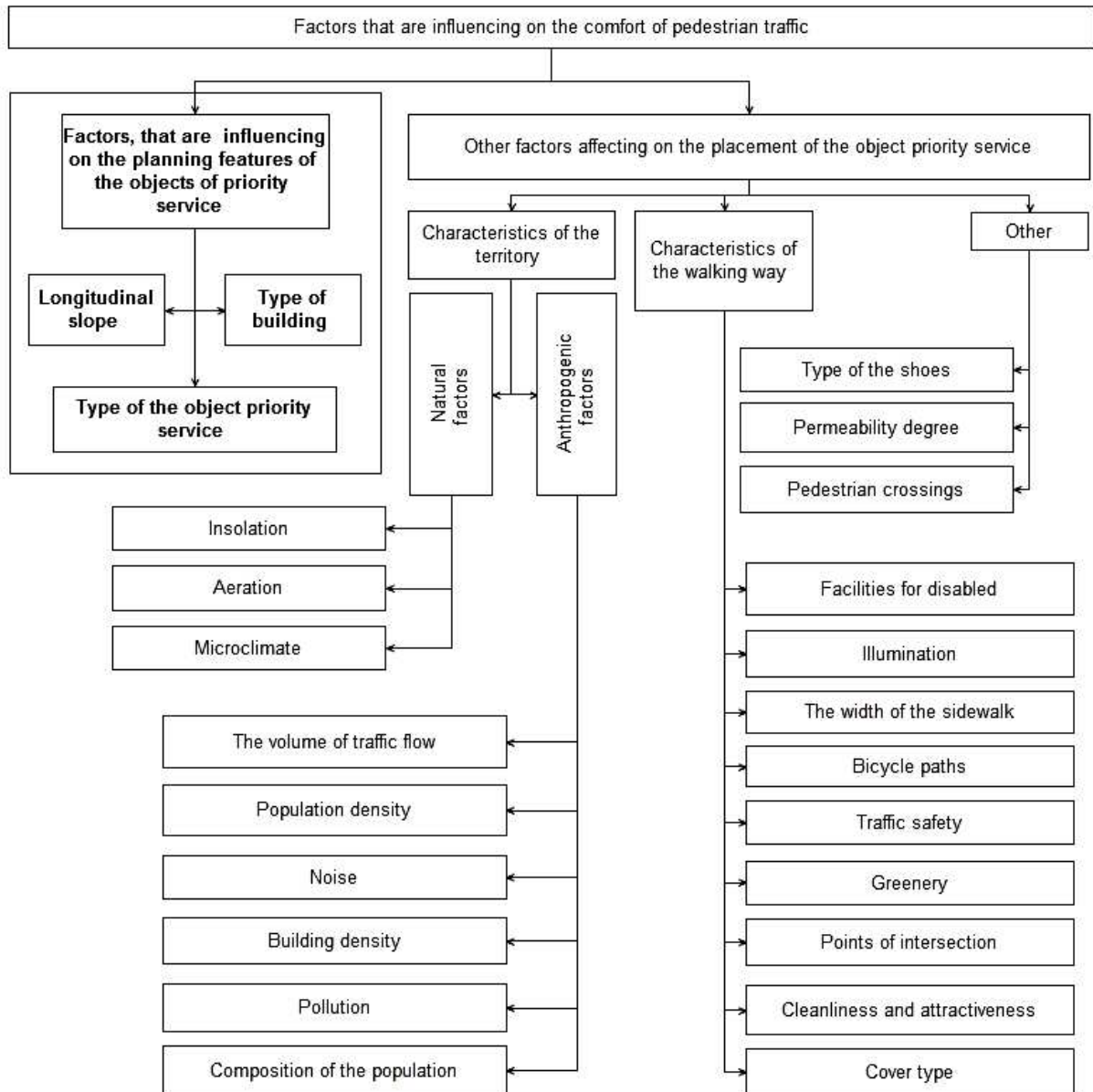

**Fig. 1.** Factors that are influencing on the comfort of pedestrian traffic

Infrastructural factors are: existence of public transport stops, presence and quality of walkways, presence of obstacles on the walking way lines, insolation, aeration, noise and speed of the traffic and so on [10]. This and other factors are divided into the groups and are presented in the figure 1. Also was defined character of factors' influence on each other, the degree of the influence and dependence of each factor (Tab. 2). Finally were defined the most fundamental (most depended and most powerful) from the point of view of comfort movement factors. It is

built-upness, volume of transport traffic, character of bicycle tracks placement, green plants and pedestrian paths. Also was defined the factors' group, that is influencing on the first service objects placement, according to what the investigation is being held (Fig. 1).

In this work factors that are influencing on pedestrian radius is look like a numbers indices that characterizes each of them. Such index is a coefficient that takes into consideration moving comfort according to one or another factor. The presence of several coefficients like this permits to make a model that

will make the displacement of pedestrians more comfortable through optimization of first-service object placement. Moreover, this model gives a possibility to appreciate built-up territory from the point of view of the living comfort in any of its part. That is why here are examined factors, that are influencing on gravity objects.

One of the most significant factors is the territory planning lay-out of built-up. There are 5 types of this built-up kind – perimetral, group-wide, lineage, free and compound built-up [4]. Each of it has its own influence on the movement track of pedestrian, that is why the coefficient of nonlinearity, that is common for each of them. Coefficient of nonlinearity – measurement, that reflects the correlation of length of the path between two points with air distance.

In a result of analysis of the planning

structure of Kiev [14], were chosen territories with the most characteristic type of built-up. As perimetral – Podil, group-wide – Nykilska Borchagivka, lineage – Rusanivka, free – Batyev hill. Compound built-up combined elements of other types, that is why the coefficient of nonlinearity, that is typical for it, is direct average of all other coefficients.

One of the most significant factors is the territory planning lay-out of built-up. There are 5 types of this built-up kind – perimetral, group-wide, lineage, free and compound built-up [4]. Each of it has its own influence on the movement track of pedestrian, that is why the coefficient of nonlinearity, that is common for each of them. Coefficient of nonlinearity – measurement, that reflects the correlation of length of the path between two points with air distance.

In a result of analysis of the planning

**Table 2.** The degree of influence and dependence of factors affecting the comfort of pedestrians (where  $M$  is the degree of effect) – part 1

Factor	1	2	3	4	5	6	7	8	9	10	11	12
1. Insolation		0	1	0	0	0	0	0	0	0	0	0
2. Aeration	0		0	0	0	0	0	0	1	1	0	0
3. Microclimate	0	0		0	0	0	0	0	0	0	0	0
4. Lay-out type	1	1	1		0	1	0	0	1	0	0	0
5. Attraction object type	0	0	0	0		0	0	1	0	0	0	0
6. Built-upness	1	1	1	1	0		1	0	1	1	1	0
7. Density of population	0	0	0	0	0	1		0	1	1	1	0
8. Population composition	0	0	0	0	1	0	0		1	1	1	0
9. Noise	0	0	0	0	0	0	0	1		0	0	0
10. Pollution	0	0	0	0	1	0	0	1	1		0	0
11. Traffic volume	0	0	0	0	1	0	0	0	1	1		1
12. Longitudinal slope	0	0	0	0	0	1	0	0	0	0	1	
13. Illumination	0	0	0	0	0	0	0	1	0	0	1	0
14. Width of footpath	0	0	0	0	0	0	0	1	0	0	0	0
15. Bikeway presence	0	0	0	0	0	0	0	1	0	0	0	0
16. Traffic safety	0	0	0	0	0	0	0	1	0	0	0	1
17. Green space presence	1	1	1	0	0	0	0	1	1	1	0	0
18. Flows cross point	0	0	0	0	0	0	0	1	0	0	1	0
19. Cleanness and attractivity	0	0	0	0	0	0	1	1	0	1	0	0
20. Coverage type	0	0	1	0	0	0	0	0	1	0	0	0
21. Conditions for disabled	0	0	0	0	0	0	1	1	1	1	0	1
22. The degree of permeability	0	0	0	0	0	0	0	0	0	0	0	0
23. Type of shoes	0	0	0	0	0	0	0	0	1	0	0	0
24. Type of pedestrian crossings	0	0	0	0	0	0	0	1	0	1	1	0
The degree of dependence	3	3	5	1	3	3	3	12	11	9	7	3

structure of Kiev [14], were chosen territories with the most characteristic type of built-up. As perimetral – Podil, group-wide – Nykilska Borchagivka, iainage – Rusanivka, free – Batyev hill. Compound built-up combined elements of other types, that is why the coefficient of nonlinearity, that is typical for it, is direct average of all other coefficients.

For investigation was chosen one of the objects type of attraction – school, as a big amount of permanent users that has the biggest fixed radius, that is why margin of error will be the lowest. Every territory was divided into zones through the making a Voronoy diagram [1], each part of that was served by its own school. Afterwards were made tracks of pedestrian ways from the far-est entrances. For this tracks are defined coefficients of nonlinearity, the average meaning of which are coefficients of influences of

territory lay-out.

For evaluation of accessibility for pedestrians there are several international internet resources as Walkonomics, Walk Score, RateMyStreer ets. They are evaluating and measuring accessibility for pedestrians trough making pedestrian audition. For example, RateMyStreet gives possibility for users to rate any street in eight categories – commodity of road crossing, the width of pavement, driving risks, traffic organization commodity, safety from the point of view of criminality rate, cleanness and attraction, accession for handicapped. In countries of western Europe and Northern America, in contrast to Ukraine, this systems are being used intensively for evaluation of pedestrian accessibility. Correspondingly to gather statistics about Ukrainian cities using this programs is impossible.

**Table 2.** The degree of influence and dependence of factors affecting the comfort of pedestrians (where  $M$  is the degree of effect) – part 2

Factor	13	14	15	16	17	18	19	20	21	22	23	24	M
1. Insolation	1	0	0	1	1	0	1	0	0	0	0	0	5
2. Aeration	0	0	0	1	0	0	0	0	0	0	0	0	3
3. Microclimate	0	0	0	1	0	0	0	0	0	0	0	0	1
4. Lay-out type	1	0	0	1	0	0	1	0	0	1	0	0	9
5. Attraction object type	1	1	1	0	1	1	0	0	1	0	0	1	8
6. Built-upness	1	1	1	1	0	0	0	0	0	1	0	0	13
7. Density of population	0	1	1	1	0	1	0	0	0	0	0	1	9
8. Population composition	0	1	0	1	0	0	1	0	1	1	1	1	11
9. Noise	0	0	0	1	1	0	1	0	1	0	0	0	5
10. Pollution	0	0	1	1	1	0	1	0	1	0	0	1	9
11. Traffic volume	1	1	0	1	1	1	1	0	0	0	0	1	11
12. Longitudinal slope	0	0	1	1	0	0	0	0	1	0	0	0	5
13. Illumination		0	0	1	0	0	1	0	1	0	0	0	5
14. Width of footpath	1		0	1	1	0	1	0	1	1	0	0	7
15. Bikeway presence	1	1		1	1	1	1	1	1	1	0	1	11
16. Traffic safety	1	1	1		1	1	0	1	1	1	0	1	11
17. Green space presence	1	1	0	1		0	1	0	1	0	0	0	11
18. Flows cross point	1	1	0	1	0		0	0	1	1	0	1	8
19. Cleanness and attractivity	1	1	1	0	1	0		0	0	0	0	0	7
20. Coverage type	1	0	1	1	0	0	1		1	0	1	0	8
21. Conditions for disabled	1	1	0	1	1	1	0	1		1	0	1	13
22. The degree of permeability	0	1	1	1	0	0	0	0	1		0	0	4
23. Type of shoes	0	0	0	1	0	0	0	0	0	0		0	2
24. Type of pedestrian crossings	1	1	1	1	1	1	0	0	1	1	0		11
The degree of dependence	14	13	10	21	11	7	11	3	14	9	2	9	

Taking into consideration the fact that for this article the evaluation of concrete territories is less important than tendencies, laws and principles of accessibility for pedestrians formation, there was held questionnaire of Kiev citizens, with the aim to find out time losses on movement to every first service object. The reason why time was chosen as figure of merit – it is easier to define time, for the average person, than the distance, and absence of strong dependence on the norm, with which the majority of pedestrians are unfamiliar. Citizens were divided into categories according to their age, and during the investigation was estimated their speed of walking. That gave a possibility to turn time results received from the questionnaires into the distance. After cancelation of mistakes made during questionnaire on Dixon's  $Q$ -test [11] were defined correlations between desirable and normative radiuses for every first service objects [7]. This correlation is coefficient of the first service object type influence and presented in table 1.

Longitudinal slope of pedestrian way also influences on comfort of motion. Usually pedestrians are walking at sidewalk along carriageway. At big slopes rises the amount of oxygen that organism consumes, along with that rises the amount of harmful moieties that come into lungs. In the Building Code DBN 360-92 [3] you can find a table of radius change at accessibility for pedestrians in dependence of territory slope (Tab. 3). As in case with normative radius, there are no links on investigations in this theme. It appears a question of benefit of usage of this

results in urban construction conditions.

The moment of now is being held the investigation of regime changes of pedestrian organism on different slopes, with condition that he moves always with one speed. The influence is being determined by next parameters: pulse, temperature and oxygen level in blood. In this case are being used – pulse oximeter Kernel KN-601E, thermometer Microlife MT3001 and stop watch. Such investigation permits to receive the coefficient of longitudinal slope of pedestrian way on radius of accessibility for pedestrians.

## RESULTS AND DISCUSSION

Basing on results that we achieved during investigation, was made formula of computation of comfort radius definition service for objects of attraction:

$$R_C = R_N \times \frac{K_1 \times K_2}{K_3},$$

were  $R_C$  – is comfort target radius,  $R_N$  – normative radius from Building Code DBN 360-92\*\* [3] (Tab. 3),  $K_1$  – coefficient of attraction object type formed according to results of pedestrian audition,  $K_2$  – coefficient of longitudinal slope way,  $K_3$  – coefficient of lay-out territory type influence, that was defined before with non-linear coefficient. This kind of correction of normative mark gives possibility not only to create new building-up with more comfortable life conditions, but to make right evaluation of comfort of already existing territories.

**Table 3.** Service radius reduction depending on territory slopes (Building Code 360-92, application 6.3 Tab. 2)

Slope(per mille)	Service radius reduction for different objects depending on territory slide				
	300	500	750	1000	1500
0-5	300	500	750	1000	1500
10	180	300	450	600	900
20	90	150	225	300	450



## CONCLUSIONS

1. Analysis of normative base showed that actual normative radiuses don't have enough objectivations for being considered comfortable in actual urban construction situation.
2. Were defined and classified big amount of factors that influence on pedestrian traffic, that caused the necessity of taking those of them into consideration, that are influencing on lay-out principles of citizens objects of attraction.
3. Investigation results usage in urban-construction and lay-out activity will rise the comfort of living territories from the point of view of accessibility for pedestrians.

## REFERENCES

1. **Aurenhammer F., 1991.** Voronoi Diagrams – A Survey of a Fundamental Geometric Data Structure. *ACM Computing Surveys*, 23(3): 345–405.
2. **Vetrova N., 2012.** Ecological audit and ecological monitoring in environmental safety management of a region. *TEKA: kom. Mot. Energ. Roln., OL PAN*, Vol. 14, t.1., 80-85 (in Russian).
3. **DBN 360-92\*\*, 1993.** Urban Planning. Planning and development of urban and rural settlements. Kyiv, Ukraine State Building and Architecture. (in Ukrainian).
4. **Designers** reference: Urban Planning, **1978.** Under-editing Belousova V., Moscow, Stroyizdat, 367. (in Russian).
5. **Frank, et al., 2006.** Many Pathways from Land Use to Health. *Journal of the American Planning Association*, 77.
6. **Golubenko V., 2013.** Analysis of influence factors on urban radius walking distance. *Urban Planning and Territorial Planning. Scientific and Engineering.* Under-editing Osyetrin N. Kyiv., KNUCA, Vol.49. 119-124. (in Ukrainian).
7. **Golubenko V., 2014.** Analysis of the impact on the population's wishes by walking distance. *Urban Planning and Territorial Planning. Scientific and Engineering.* Under-editing Osyetrin N. Kiev, KNUCA, Vol.52. 58-63. (in Ukrainian).
8. **Grignaffini S., Cappellanti S., Cefalo A., 2008.** Visualizing sustainability in urban conditions. *WIT Transactions on Ecology and the Environment*, Vol. 1, 253-262.
9. **Kubacki K., 2006.** Should we always use the mean value. *TEKA: Kom. Mot. Energ. Roln., OL PAN*, Vol. 6, 55-67.
10. **Ramirez, et al., 2006.** Indicators of Activity-Friendly Communities. An Evidence-Based Consensus Process. *American Journal of Preventive Medicine*. 15–24.
11. **Rorabacher D., 1991.** Statistical Treatment for Rejection of Deviant Values. *Critical Values of Dixon Q Parameter and Related Subrange Ratios at the 95 percent Confidence Level.* *Anal. Chem.*, 63.2, 139–146.
12. **Rules** and regulations of planning and building cities, **1958.** State Publishing House of Literature on construction and architecture. Moscow (in Russian).
13. **Saprykina N., 2002.** Basic concepts and modern urban problems of reconstruction of residential environment mid-1950s-1960s. *Yaroslavl architectural almanac housing*, Vol. 4, Yaroslavl. (in Russian).
14. **Shulkevich M., Dimitrenko T., 1982.** Kiev Architectural and historical essay. 6th ed. Kiev. Budivelnik, 464. (in Russian).
15. **Słowik T., Piekarski W., Pawlak H., 2005.** Wayside relief and concentrations of selected heavy metals ions caused by motor industry insoil. *TEKA: kom. Mot. Energ. Roln., OL PAN*, Vol. V, 198-205.
16. **SNIP.** Part 2. Building design standards. State Publishing House of Literature on construction and architecture, **1954.** USSR State Building. Moscow. (in Russian).
17. **SNIP.** Part 2. Section K. Chapter 2. Planning and construction of populated areas, **1967.** USSR State Building. Moscow. (in Russian).
18. **SNIP.** Part 2. Head 60. Planning and development of cities, towns and rural settlements, **1985.** USSR State Building. Moscow. (in Russian).
19. **SNIP 2.07.01-89.** Urban planning. Planning and development of urban and rural settlements, **1989.** USSR State Building. Moscow. (in Russian)
20. **Yargina Z., Kositsky Y., Vladimirov V., etc., 1986.** Fundamentals of the theory of urban development. High school textbook, Architecture. Under-editing Yargina Z. Moscow, Stroyizdat, 326. (in Russian).

## ПУТИ ОПРЕДЕЛЕНИЯ КОМФОРТНЫХ РАДИУСОВ ПЕШЕХОДНОЙ ДОСТУПНОСТИ ДО ОБЪЕКТОВ ПЕРВООЧЕРЕДНОГО ОБСЛУЖИВАНИЯ

**Аннотация.** В статье кратко очерчена одна из основных градостроительных проблем нашего времени — пешеходная доступность. Изучена нормативная документация Украины по этому вопросу, определены и классифицированы основные факторы, влияющие на комфортность движения пешехода. Определены факторы, влияющие на планировочный аспект комфортности движения — пешеходную доступность. Представлены результаты исследований по определению влияния на неё таких факторов как тип объекта тяготения, планировочный тип застройки и продольный уклон пути. Влияние типа объекта первоочередного обслуживания определено с помощью проведения пешеходного аудита. Влияние типа застройки территории выведено с помощью определения коэффициента непря-

молинейности, характерного для пешеходных путей того или иного планировочного типа. Влияние продольного уклона определяется с помощью мониторинга изменений работы сердечно-сосудистой системы и внутренней температуры тела при движении с постоянной скоростью на различных уклонах. В результате представлен метод определения комфортной пешеходной доступности к объектам первоочередного обслуживания, который можно использовать как при планировке новой застройки, так и при оценке уже существующей. Согласно полученным данным, комфортный радиус может быть как меньше, так и больше нормативного, что даёт соответствующие экономические выгоды при использовании метода.

**Ключевые слова:** пешеходная доступность, радиус, норматив, тип застройки, уклон, коэффициент непрямолинейности.

## Easement procedure and factors which defined it in Ukraine

*Iryna Lytvynenko*

Kyiv National University of Construction and Architecture  
Povitroflotskyy prosp., 31, Kyiv, Ukraine, 03680, e-mail: ivilit@ukr.net

**Summary.** In the article various factors defining procedure of a land easement establishment when forming the new land plots are analyzed. All factors are combined into 4 groups. The analysis of influence of each group of factors on a land easement procedure in Ukraine is made.

**Key words:** right-of-way, utility, easement, easement procedure, easement establishment, factors.

a lot of time, demands considerable efforts and financial investments. The decision making of the formation of the land plot with the need to establish an easement is influenced by various factors, which act at different stages of easements establishment. This article is devoted to the study of the factors influencing the procedure of establishment of land easements in Ukraine.

### INTRODUCTION

In recent years the demand for the land plots for cottage construction has increased in the cities of Ukraine [7]. In land resource-constrained environment in the cities suitable for housing construction the new land plots which aren't serviced with utility systems and access roads are being created. It is possible to close this gap at the expense of the adjacent land plots, which brings owners of the plots to agreement. The agreements are not always formalized, as a result, citizens appeal to court. Provision of utility systems and an access to roads for new land plots is possible by official establishment of land easements.

The procedure of establishment of land easements is not clearly defined by Ukrainian law. And there is no procedure for formation of the new land plots requiring establishment of easements. Despite the adoption of a number of laws [19, 12, 13, 14] in which the stages of establishment of land easements are defined, the establishment procedure is still difficult and unclear, takes

### PREVIOUS WORKS AND PUBLICATIONS

The problem of establishment of land easements in Ukraine is studied insufficiently, despite its relevance. The most numerous publications are devoted to discussion of legal and regulatory aspects: the content of a land easement right of and its types, establishment and force, termination conditions [25, 26, 15]. Taking into consideration the unsettled procedure of easements establishment in Ukraine it is important to study and investigate international experience [16]. The experience of Scandinavian and European countries where the easement right has been successfully exercised for a long time will positively influence on functioning of a land easement in Ukraine [9, 17].

When establishing easement the questions arise of a monetary value of both the easement right, and the land plots under the action of this right. Ukrainian specialists have published a number of works devoted to the study of theoretical aspects of ease-

ment right monetary value [3, 4, 2]. In some works the necessity of procedure of formation and registration of a land easement for the cities of Ukraine is proved [6] and practical experience of establishment and registration of land easements of different type in Ukraine is generalized [10].

## PURPOSE OF WORK

To analyze factors influencing the easement procedure in Ukraine when forming the new land plots which aren't provided with utility service and an access to roads.

## EXPOSITION OF BASIC MATERIAL

While establishing easement several adjacent land plots can be involved to remove shortcomings. Further the land plot in favor of which the land easement is established will be the dominant one with adjacent plots being servient plots.

There is a large number of types of the land easement right which can have either positive or negative character. An easement is positive when the dominant plot owner has the right to do certain actions against servient land plots (passage, driveway access, utilities laying, etc.). The easement forbidding servient land plots owner to do certain actions is negative (for example, not to prevent water drainage from the adjacent plot). This article focuses on the positive private land easements.

The new land plots for cottage housing with the need of easement establishment result from 2 main cases - creation of the new land plots and division of existing mostly when receiving inheritance.

The establishment of a land easement begins with a study of the legal, technical and financial conditions for the formation of a land easement, insufficient consideration of which may lead to negative consequences of further operation of property. When establishing easement through adjacent plots it is necessary to choose the best option. There-

fore such factors as planning characteristics of the land plots, spatial structure and utility capacity and road location significantly influence the decision making on establishment of a land easement. Besides, these factors influence a land easement cost and change of market value of all adjacent land plots involved (table 1).

A set of factors influencing procedure of a land easement was defined as a result of the analysis of domestic experience of a land easement establishment and considering conditions of its further functioning, as well as the existing practice of new land plots formation. All of them were grouped into:

1. Legal, 2. Financial, 3. Planning, 4. Other.

The influence of the factors that are part of all groups can be considered as positive if the procedure of a land easement establishment is fast, inexpensive and clear for the land plot owners. Furthermore, planning characteristics of the land plots involved in a land easement establishment don't change for the worse and the market value of land is not reduced or there is a slight decrease.

The extent of the influence of factors is different. Group of legal factors act on the whole country, whereas other groups of factors have local influence on the residential district where the land plots are located.

### **Group of legal factors**

- Easement establishment under Real Estate Formation
- Easement establishment procedure & Registration in the Real Estate Register
- Technical regulations for Easements establishment
- Compensation procedure
- Documents for Easement establishment

To date, Ukraine hasn't adopted a specific law on a land easement establishment and new land plots formation. The only attempt in this direction is the draft law "On land easements", developed in 2004 [1]. But it hasn't been adopted so far.

Procedure of formation of the new land plots where land easement is needed isn't approved in Ukraine. Certain parts of procedure and the process of the new land plots formation are stated in various legislative

acts. In particular, in the Land and Civil code, a number of laws, resolutions and other acts. The Land Code contains the general definition and the incomplete list of types of land easements. Also here the general principles of establishment, action and cancellation of a land easement are given. In certain articles of the Land Code the formation of the new land plots as a result of subdivision or amalgamation is defined in general. But the process of establishment of a land easement when forming the new land plots isn't defined.

According to Ukrainian law [18, 19], private land easement may be established by the agreement between land owners, as well as the will and judgment. The contract is concluded between the owners of land in accordance with civil law by general rules. The standard form of contract for land easements has not been developed and approved. The contract may contain a validity period of land easement, a land plot plan with an indication of the easement area, the amount of monetary compensation to the owner of servient land plot, the periodicity of payment for the use of the land easement, the amount of payments and other items by mutual consent.

A number of laws determine obligation of land easement registration in the register of rights [13, 14, 18, 19], but registration procedure and a set of all the necessary documents, isn't quite clear.

The most widespread type of the easements established for new land plots for housing construction is right-of-way and utility easement [8]. It is important to define easement parameters according to building codes.

The size of land plots when laying driveway or utility is determined by Building codes. The size of the easement plot when laying utility is conditioned by the technical parameters such as the driveway width and size of sanitary protection zones. In Ukraine, road and utility construction is regulated by building codes [5, 22, 24, 27] that define their technical characteristics and certain limitations. The complexity lays in the fact that the codes don't state clearly technical

characteristics and limitations specifically for easements.

When establishing land easement the questions of financial compensation and easement payment always arise between the owners of the dominant and servient land property. According to Ukrainian law, the owner of the servient land plot may claim compensation for the land easement and recurrent fee. However, the legislation does not regulate these questions. Compensation payments are generally calculated by an independent appraiser on the basis of analysis of prevailing prices for such land plots in the real estate market and by the appraiser's own experience.

Different types of documentation are necessary at each stage land easement establishment (the formation and registration) [12, 14].

The technical documentation is developed for utility and cadastral documentation is necessary to identify the limits of the right of way. In order to establish various kinds of easement such as utility laying (water supply system, sewerage, gas pipeline, electrical network, etc.) technical documentation for each utility is developed. Types of documents and their number may vary in different regions and it is responsibility of the local utility companies.

Important component of a land easement establishment is geodetic surveying. According to the legislation the following documents are necessary for registration of a land easement: the application of the owner of the dominant property, land easement agreement, materials of geodetic surveying, the electronic exchange file, personal information of owners of the land plots involved in a land easement and some others.

#### **Financial factors**

##### **Residential district - related factors:**

- Changing of Properties Market Value
- The change of Tax payment

##### **Land plot-related factors:**

- Construction expenses
- Building materials expenses
- Expenses for project preparation

Some factors of this group have impact on the residential district, and some of them influence directly on the land plots involved in establishment of a land easement.

The effect of a land easement for the dominant property is the increase of market value, whereas for servient property market value decreases. The amount of the State Duty Tax depends on the amount of market value of the land plots. According to Re-stated Tax code [20] the State Duty Land Tax comes to local budgets. Thus, change of market value of the land plots influences filling of local budgets.

In case of land plots the cost of construction works and building materials are of great importance for owners. For the dominant property owner of the expenses will increase if utilities and roads are located far from the land plot and vice versa. In case of the optimal land easement expenses for the owner of the dominant property have to be minimum. It means that it is necessary to look for options for a land easement with an access to the nearest available roads and utilities. In this case there will be a reduction of land easement costs and reduction of the amounts of compensation payments due to reduction of the area of action of a land easement.

Easement documents preparation costs should include costs of utilities technical project, preparation of cadastral map and the registration of easement in the State Register of Rights.

Financial expenses also include surveying after easement is established. It is surveying to determine the areas of action of easement, geodetic coordinates, easement action planning and electronic exchange file creation containing geodetic information.

Financial expenses when easement is established in Ukraine are quite high, and the procedure for easement establishing takes up a lot of time. The reason is the lack of legislative regulation of procedure of land easement establishment and a large number of participants involved in the procedure from government agencies, private companies, individuals whose authority isn't clearly defined.

## **Planning factors**

### **Residential district - related factors:**

- Planning structure of residential district,
- Road network density and spatial structure,
- Utility capacity, density and spatial structure.

### **Land plot-related factors:**

- Planning characteristic of land plots,
- Location of building and utility and their characteristics,
- Location of utility and their capacity.

The planning structure of the residential district where the land plot is located is of great importance for decision-making on formation of the new land plot with easement.

One of the important characteristics of the planning structure of a residential district is roads and utility layout. [11, 23] The spatial structure and density of roads and utility capacity is of great importance. If the roads are far away or have an uncomfortable location, it will be difficult to establish right-of-way and costs for construction work and materials, surveying will increase. This also considerably increases the technical documentation preparation costs. A similar situation occurs when you connect to nearby utilities. The reasons for this may be a low density and capacity of utilities.

Planning characteristics of the land plots are referred as to land plot related factors. Planning characteristics of servient property are of greater importance for the best establishment of a land easement. The area, length of borders, configuration, length of frontal border of the land plot with an access to roads and utilities are essential for a land easement establishment. A land easement area is limited in use for the land owner due to sanitary protection zones round utilities and easements of other types. Thus one of the main requirements to land easement cancelling according to Cadastral Registry of Ukraine is impossibility to use servient plot as intended.

**Table 1.** Factors which defined Easement procedure in Ukraine

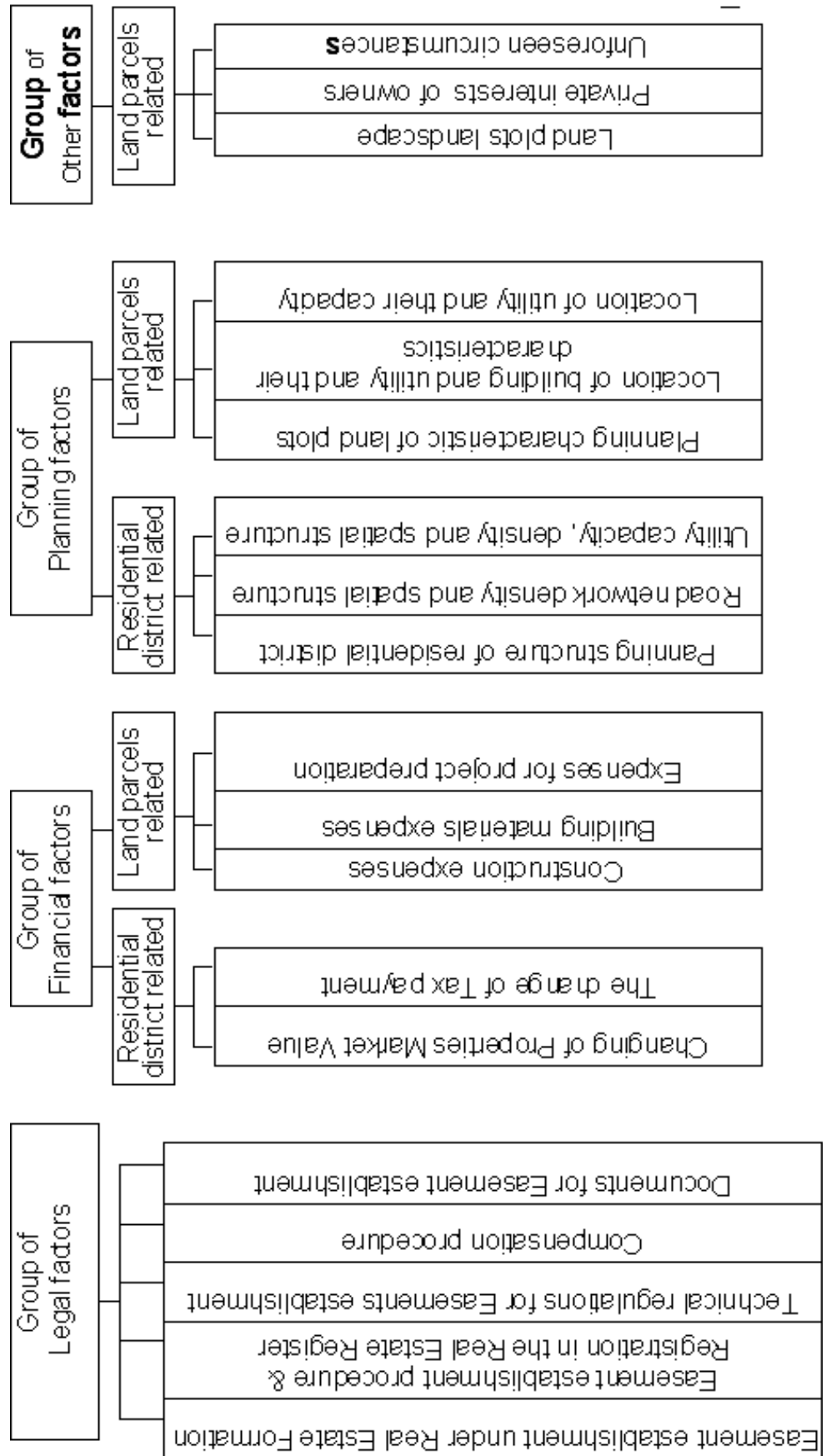

Thus, if the servient plot has insufficient space, the narrow front border, or complex configuration, it will be extremely difficult to establish easement in the least burdensome way. Easement area for right-of-way, or utility easement can occupy a significant part of land and significantly complicate or make impossible the use of the land.

Utilities location and capacity are also of great importance when establishing land easement. If the nearest utilities are of low capacity, it is impossible to connect new users to them. Solution to the problem can be either new utility corridors of appropriate capacity or connection to more distant utilities. Of course, the best option for a land easement establishment is the location of utilities of sufficient capacity at the minimum distance from the land plot. In all other cases the length of utilities will be bigger and more expensive.

**The group of other factors includes:**

- Land plots landscape,
- Private interests of owners,
- Unforeseen circumstances.

Geomorphologic characteristics of land are of great importance for the utilities laying and driveway formation. Compound relief can cause technical difficulties in utilities and roads laying. At best, compound relief can create additional difficulties for engineering solutions and related to them additional financial cost. At the worst, it will be impossible to establish land easement due to complex technical solutions and a significant increase in the cost of work.

One of the factors having a major impact on the further procedure of land easement is personal interests of land owners.

If the owners of land fail to reach agreement this issue can be settled in court. The decision on the easement establishment is taken by court on the base of alternatives, developed by forensic experts.

During a land easement establishment unforeseen circumstances of various origin can happen. They can be of natural and anthropogenic origin, affecting the physical characteristics of land plot. Among them there are landslides, landslip seams and others. Acci-

dents with the persons involved in procedure of a land easement establishment belong to unforeseen circumstances too. These include accidents with land owners and contractors, financial bankruptcy of land plot owners and circumstances, resulting in the change of land owners and others. These factors and some other factors of political, economical and legislative origin are not considered in detail in the article but they should be taken into account in the general approach to the easement formation.

## CONCLUSIONS

The major factors influencing a land easement establishment procedure is the group of legal factors.

Land plot related planning and financial factors have considerable impact at a stage of decision making on a land easement establishment and expediency of property formation. Insufficient study can lead to the wrong decisions when forming the new land plots and to considerable financial and moral damage.

In easement establishment several plots of land and a large number of persons may be involved. Improper new land plot formation with incorrectly established land easement can have significant consequences. The adoption of economically viable and socially equitable solution is possible only by studying and considering all the factors that are not being considered currently when establishing easement in Ukraine.

## REFERENCES

1. **Draft** of law "About land easement", **2004**. *Zemlevporiadny visnik*, Kyiv, Vol. 3, 55-59. (in Ukraine).
2. **Drapikovskiy O., Ivanova I., 2002**. Assessment of land ownership to development. *Land market*, Kyiv, Vol. 2, 38-43. (in Ukraine).
3. **Drapikovskiy O., Ivanova I., 2012** Real Estate assessment of municipal and state ownership. *Town Development and Spatial Planning*, Kyiv, Vol. 46, 197-213. (in Ukraine).



4. **Drapikovskiy O., Ivanova I., 2012.** Scope of subject of real estate assessment in view international standards. *Town Development and Spatial Planning*, Kyiv, Vol. 46, 214-219. (in Ukraine).
5. **Gas-supply** equipment plumbing installation Buildings and constructions installation. Outside utilities and constructions, **2001.** Construction standards and regulations of Ukraine, DBN B.2.5-20-2001, Derzbud of Ukraine, Kyiv, 192. (in Ukrainian).
6. **Guzchenko Y., Petrakovska O., 2003.** Demand of land easement procedure in Ukrainian cities. *Town Development and Spatial Planning*, Kyiv, Vol. 16, 57-61. (in Ukraine).
7. **Klys M., 2014.** Analysis of space planning and design decisions modern cottage. *Motrol: kom. Mot. Energ. Roln., OL PAN*, Vol. 16, 73-80.
8. **Lytvynenko I., 2012.** Easement establish approaches by court decision. *Town Development and Spatial Planning*, Kyiv, Vol. 46, 343-346. (in Ukrainian).
9. **Lytvynenko I., 2009.** Easement establish approaches from foreign experience. *Town Development and Spatial Planning*, Kyiv, Vol. 34, 261-264. (in Ukrainian).
10. **Lytvynenko I., Proskurka O., 2013.** Practical aspects of easement establishment in cities. *Town Development and Spatial Planning*, Kyiv, Vol. 50, 364-370. (in Ukrainian).
11. **Novohatnuji V., Kostenko S., 2013.** Reliability of conduits of water supply system. *Motrol: kom. Mot. Energ. Roln., OL PAN*, Vol. 15, 101-108.
12. **On Land Management.** Law of Ukraine, **2003.** № 858-IV. <http://zakon4.rada.gov.ua/laws/show/858-15>. (in Ukrainian).
13. **On the State Land Cadastre.** Law of Ukraine, **2011.** № 3613-VI. <http://zakon4.rada.gov.ua/laws/show/3613-17>. (in Ukrainian).
14. **On State Registration of Corporeal Rights to Real Estate and Their Encumbrances.** Law of Ukraine, **2004.** № 1952-IV. <http://zakon4.rada.gov.ua/laws/show/1952-15>. (in Ukrainian).
15. **Pentela-Pravdiuk N., 2011** Easement is right to use nearby land plot or its part. *Zemlevporiadny visnik*, Kyiv, Vol. 2, 42-44. (in Ukraine).
16. **Petrakovska O., Guzchenko Y., 2004.** Survey of international land easement right experience. *Town Development and Spatial Planning*, Kyiv, Vol.18, 52-58. (in Ukraine).
17. **Petrakovska O., Malashevskiy M., 2013** Easement establishment experience from Finland. Scientific work DonNTY. Mining and geological series. Under editing Baskov E. Number 1(18). Donetsk, 266 – 271. (in Ukraine).
18. **The Civil Code of Ukraine, 2003.** №435-IV. <http://zakon4.rada.gov.ua/laws/show/435-15>. (in Ukrainian).
19. **The Land Code of Ukraine, 2001.** №2768-III, <http://zakon4.rada.gov.ua/laws/show/2768-14>. (in Ukrainian).
20. **The Tax Code of Ukraine, 2010.** №2755-VI <http://zakon3.rada.gov.ua/laws/show/2755-17>. (in Ukrainian).
21. **Town building.** Planning and building of urban and rural settlements, **2002.** Construction standards and regulations of Ukraine, DBN 360-92\*\*. Derzbud of Ukraine, Kyiv, 46. (in Ukrainian).
22. **Water supply.** Outside utilities and constructions. The main principles of design, **2013** Construction standards and regulations of Ukraine, DBN B.2.5-74:2013, Minregionbud of Ukraine, Kyiv, 172. (in Ukrainian).
23. **Saliev E, 2013.** Reliability of the functioning of the water supply and sewerage system. *Motrol: kom. Mot. Energ. Roln., OL PAN*, Vol. 15, 53-63.
24. **Sewerage.** Outside utilities and constructions. The main principles of design, **2013.** DBN B.2.5-75:2013, Minregionbud of Ukraine, Kyiv, 134. (in Ukrainian).
25. **Sosnina G., 2008.** Legislative regulation of easement in Ukraine. *Herald of Odessa National University named I.Mechnikov*, Odessa, Astroprint, Vol. 13, issue 10, series “ Jurisprudence”, 71-76. (in Ukraine).
26. **Spicina L., 2007.** Easement establishment by parties agreements and by court decision *Zemlevporiadny visnik*, Kyiv, vol. 3, 27-31. (in Ukraine).
27. **Streets and roads of cities, 2001.** DBN B.2.3-5-2001, Derzbud of Ukraine, Kyiv, 50. (in Ukrainian).

**ФАКТОРЫ, ВЛИЯЮЩИЕ НА ПРОЦЕДУРУ  
УСТАНОВЛЕНИЯ ЗЕМЕЛЬНЫХ  
СЕРВИТУТОВ В УКРАИНЕ**

**Аннотация.** В работе проанализировано различные факторы, влияющие на процедуру установления земельных сервитутов при формировании новых земельных участков для

жилищного строительства. Все факторы объединены в четыре группы. Проведен анализ влияния каждой группы факторов на установление земельных сервитутов в Украине.

**Ключевые слова:** право прохода и проезда, инженерные коммуникации, сервитут, установление сервитута, факторы.

## Labor skeleton frame as functional and spatial system of city planning and management

*Daria Svoboda*

Kyiv National University of Construction and Architecture  
Povitroflotskyy prosp., 31, Kyiv, Ukraine, 03680, e-mail: hetri@rambler.ru

**Summary.** Models of work localization places originated in ancient towns and cities of the Renaissance period. Regularities of geometrical dependences are traced in many theories of the cities. An important criterion for the quality of the city planning structure is travel time-weighted average to the main places of work.

**Key words:** the labor skeleton frame forms, localization of places of work, labor links of the city, system of labor links.

### INTRODUCTION

It's not possible for researchers of city-planning theories to find the single universal decision how to denote all existing city-planning problems neglecting specific conditions of the country, its history and natural features. At the beginning of 21 century we see historically developed system of urban environment. The city is not only roads, buildings, greenery planting. It is first of all adaptive visual and time criterion of a city development.

- the visual criterion is characterized by modern perception of reality;
- the time criterion is characterized by feeling of lost time and space.

City environment, image and entity are created on the basis of natural and social requirements. From the point of view of an urbanization, the city has its social, spatial and functional structures. The city is formed by its inhabitants, striving to satisfy the requirements in the best way.

### PURPOSE OF WORK

Work on the problems of labor support (Labor resources) in the district planning is mainly based on the materials and conclusions collected, processed and formulated by planning and project organizations. Thus, the main objective has always been to reach optimal proportions in the allocation of production facilities and population.

### WAYS TO REVEAL THE PRINCIPLES FUNDAMENTAL FOR SPATIAL IN- TERACTIONS BETWEEN CITIES

Since ancient times city development has been a conscious process, conducted in accordance with the particular needs of the residents. It can be assumed that at the very early stages of city development, people created an idea about the most convenient location, major communications layout, location of temples, palaces and other buildings. These principles were gradually implemented and put to test, and can be fairly referred as to primary city development theories. The main points of ideal utopias of the past are characterized by the desire for simplicity, convenience, "availability" of a city for its residents in different variable formations. Architects and researchers sought to create new ideas of city-planning systems. The ideas and developments in ideal city creation were later transformed into utopian

theories of cities. The main idea at that time was in the definition of the division of labor of city dwellers. Ways to reveal the principles fundamental for spatial interactions between cities (movement of people, goods, information, diffusion of innovations, other relationships), led to the idea to use fundamental law of gravity, according to which any two bodies in the universe attract each other with a force that is directly proportional to the product of their masses and inversely proportional to the square of the distance between them, where population is taken as a mass. The city has to carry out a leading comprehensive social and economic role within the controlled area. There is a variety of different characteristics, one of which is apparently inherent in the whole settlement system as a whole, and the other will characterize individual settlements. The population of the city has functional role which is characterized, in particular by its activity (work), life, and rest. It forms a vector of land use which is differentiated according to functional grounds: residential areas, production areas, recreation areas, etc.

#### DEVELOPMENT OF PLANNING GEOMETRICAL INTERPRETATION

The expression of the spatial distribution of the main urban processes is rather complex and controversial. Streets and roads form planning structure of the city. Three main forms of urban planning - centric, linear and lattice - were known in ancient times, when the first cities emerged. Various combinations and modifications of these basic forms can be seen in the plans of modern cities. Such integral city plans are of the greatest city-planning interest. Development of planning geometrical interpretation is conventionally represented as follows.

1. Point, center, circle – have no direction of growth, the function is a static one.

The circular plan originates from the natural development of the city around the primary core, which historically represented a road intersection. Circle or polygon, having a

minimum perimeter and equal access to the center met the requirements of defense in the best possible way. The main disadvantages of city plan:

- when increasing radius, functional connections of territories are violated,
- Lack of the reserve area for the expansion.

Therefore, in modern design practice expediency of use of round or polygonal radial-ring plan should comply with the following conditions:

- The size of an urban area doesn't exceed the radius of walking accessibility from the center according to regulatory documents.

Clear regulation of urban development beyond designed outer fringes (for towns). Functionally, such a plan is simple and convenient, and doesn't require complex pedestrians isolation from transport and provides urban residents with close accessibility of the suburban environment.

2. The line, a strip, a row – develop in two opposite directions, the function is a dynamic one;

Linear city plans are formed through historical aspect of arrangement of the main transport ways or settlements along the rivers. General pattern of linear plotting is based on differentiation of city traffic – lengthwise and crosswise.

For simple primary form of linear city plan typical width corresponds to accessibility for pedestrians and length is longer if the speed of public transport increases. Transport accessibility time between opposite points of a closed circuit is also reduced twice compared to the extreme points of disconnected line segment of the same length. Primary linear form of the plan can function properly and be kept until the city growth exceeds the limits of time proximity.

Being closed, linear-circular shape of the plan can't provide longitudinal growth. If there is a need of further territorial development, it can be achieved by adjunction of new rings. Thus, at the junction and intersection of rings the most expedient places for the city centers are recorded. The double planning ring – "eight" – having the same

length as a simple ring allows to reduce by half trip time from the center to the suburbs. Application linear – circular forms of the city plan provides:

- Intensity of high-rise development concentrates in a radius of foot availability round stopping places of city public transport;

- High-speed highways at the intersection with pedestrian walkways should be placed out of earth level. Linear – branchy form of the city plan is characterized by splitting of the main roads as they move away from highways, and also by oblique-angled roads in respect of driveway junction with the house surrounding blind pass parking's. When joining the neighboring blind passes into the continuous driveway, branchy form of planning turns into linearly – loopback or lattice one. Linear – branched form of the city plan has the following features:

- the absence of any crossing of transportation and pedestrian routes on the same level;

- compatibility with any natural conditions.

Simple linear city map can be transformed, thus forming new, secondary lines, perpendicular to the main line.

3. Square, lattice - develop in several mutual directions, their function is either neutral or combines elements of statics and elements of dynamics.

The rectangular city planning grid has always been the result of purposeful design, but not intuitive spontaneous construction. The rectangular lattice-shape plan, unlike centric-circular, evenly duplicates all traffic directions without overloading of the city center, which is provided with relative freedom of spatial development.

Simple square – shaped city plan combines the convenience of a right angle with the maximum compactness.

The increase in the size of the city, as a rule, deforms the square plan under the influence of functional and transport and landscape factors. Besides, designed composition change of a square shape of city map is also possible by means of obtuse and acute angles, curves or broken lines of its boundaries.

In square-shaped city map the diagonal grid of streets provides better accessibility between the center and its outer contour angles, than the grid parallel to a square sides.

#### FUNCTIONAL AND TERRITORIAL DIVISION OF THE CITY AREAS FORMATION

Quite often the territory in the toponimic parts of the city is of monofunctional nature. Other parts of the city, on the contrary, form multifunctional system, combining some main functions.

This is natural balance of the functional and territorial division of the city areas formation.

For example, for the historically developed industrial areas isolation and monofunctional character allows to create the best conditions both for production, and for work and service of employed workers.

On the contrary, in residential areas of the city where everyday life and leisure of citizens are concentrated, location of industrial, municipal or other facilities is unacceptable.

It would be inadvisable, because noise and heavy freight traffic badly affect the activity of these zones.

This area requires build-up of communal facilities, places where other jobs can be applied (science, management, design, banks, technology IT, etc.), as well as culture, leisure and recreation facilities.

Therefore, as a rule, these residential areas have additional polyfunctional nature.

The complex polyfunctional zone of the city is its community center – social and business zone.

City center concentrates the main functions of social,

political, administrative, cultural life and service of people.

Functional analysis of civil structure shows that all the functions of the center, as well as the city as a whole, are divided into three groups:

- activity (work) (social and political work and management, education, science),

- life (food, trade, public service, housing),
- leisure (culture and sport).

Recreational area is a special functional area, which is usually of monofunctional nature.

But this division of a functional zoning of the city areas is a problem of planning integrity of the city.

None of the functions of the city, taken alone, exists by itself.

Alternation of life cycles of work, life and recreation is a basis of urban lifestyle.

Therefore the planning structure of the city can't be reduced to the structural organization of functional zones and their elements.

It is defined primarily by their mutual rational placement and the ability to create a comfortable, constant and reliable interconnection of all parts of the city.

The key to the unity of urban spatial structure is sustainable location of production and workers resettlement taking into account technological requirements of industry, an objective mechanism of social behavior of citizens in urban settlement, sustainable development and changes in intra-urban relationships in space and time.

To perform successfully city functions about a half of the population has to be efficient and this part of the population constitutes a city labor force.

Permanent population of employable age group in the general aspect of total population ensures its stable "labor balance".

The basis of urban development is a process of concentration of the various activities throughout all historical eras.

So, concentration processes are at the heart of city growth and development.

It should be noted here that it means not only increase in volume of already existing activities, but an emergence of new types and industries and increase of their diversity.

Appropriate use of urban environment qualities provides an increase in productivity, acceleration of scientific and technological progress, new inventions in technology, discoveries in science, new trends in culture.

Compactness of the city plan, the developed system of transport communications,

less difference in indicators of intensity of land use planning and management cause an appreciation of its quality.

An important criterion for the quality of the city planning structure is travel time-weighted average to the main places of work.

The quantitative assessment of the accessibility of a certain site of the city is determined by the degree of its accessibility – how much its accessibility is above (or below) city average.

## THE DEFINITION OF THE CITY LABOR SKELETON FRAME

Models of work localization places originated in ancient towns and cities of the Renaissance period.

Regularities of geometrical dependences are traced in many theories of the cities.

But to determine key parameters of emergence of models which could designate accurate gradation of existence of the specified work localization places, it is necessary to define the concept "of the city labor skeleton frame" at first.

The labor skeleton frame is 3D design consisting of a combination of vertices and ribs which create polygon, or tissue which is directed on workforce loading and ensures work places permanency.

This creates spatial and organizational infrastructure that supports employment stability, creates a constant and continuous movement, prevents disintegration and integrity of the working space.

To obtain stable working environment it is necessary to consider a number of factors which influence its form:

- 1) labor interest,
- 2) transport accessibility to work places,
- 3) prestige of the enterprises,
- 4) sensual and emotional factor of the person and others.

The labor skeleton frame forms the system of sets of working places localizations, interconnected labor links that interact with each other and with the systems of urban environment as a whole.

The system of city labor skeleton frame is a set of objects united so that they exist (function) as a whole, creating new properties that are not available in these objects taken separately.(Fig. 1).

The structure skeleton of a labor city has complete system of labor links and consists of (see Fig. 1):

- Localization of places of work – a set of objects of application of work (labor formations) of the city, at the municipal, district and local levels,
- Labor polygon – a segment of localization of places of work which has its function and direction of a vector of development of education,
- Labor node – a single object of employment provision for the city,
- Labor links of the city – a system of

links which joins labor polygons according to the function and transport accessibility at all city levels,

- A labor vector – the direction of development of functions of labor nodes in the labor polygon.

There are several main features of the system of labor links:

- 1) integrity – city labor links should be uniform and interconnected,
- 2) structuring – each labor node should have its rank of the system,
- 3) coordination – a combination of labor links of different type, which reinforce its efficiency,
- 4) subordination of parts to one purpose – labor links have one directional vector,
- 5) an algorithmic character of activity (in logical sense) – an exception of illogical ex-

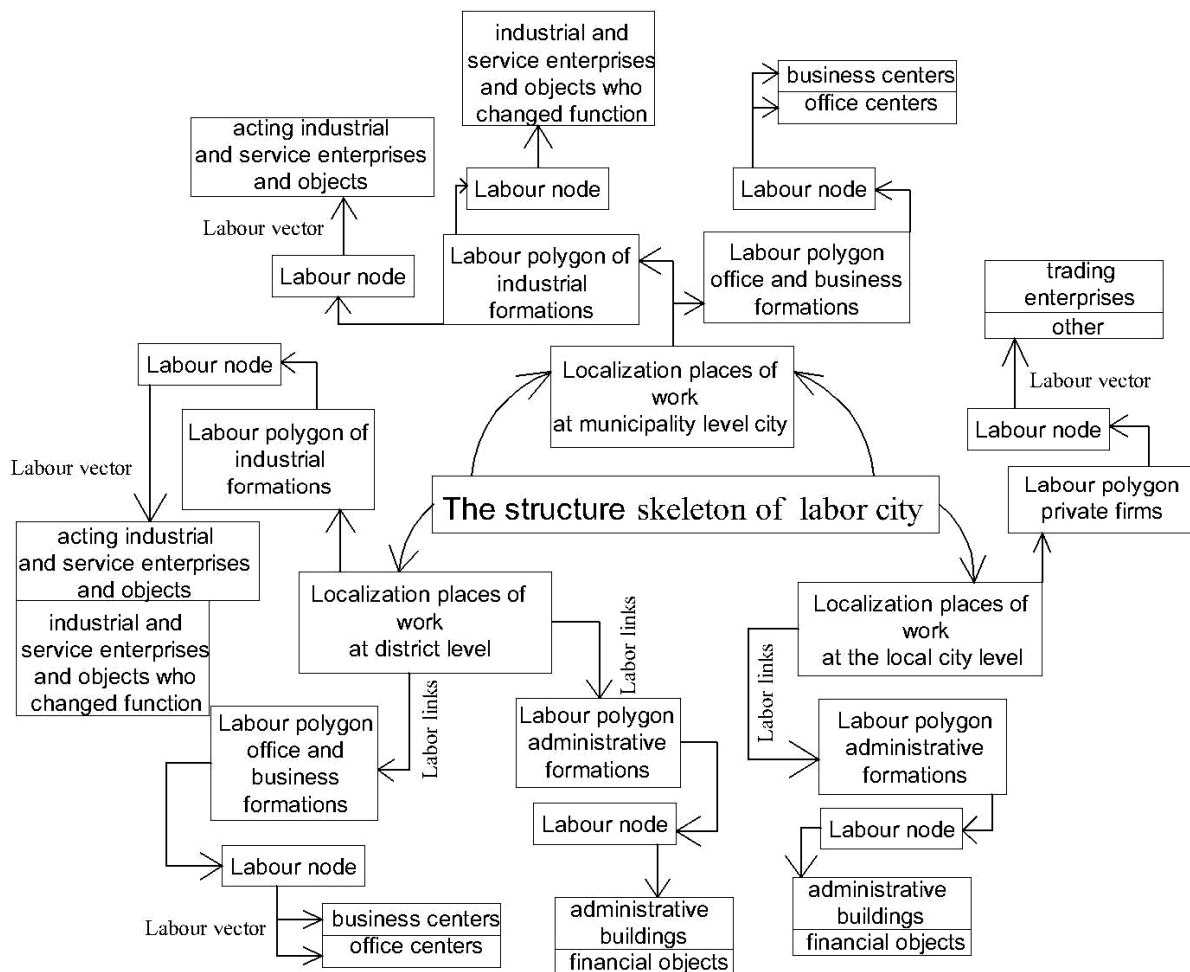

Fig. 1. The structure skeleton of a labor city

istence of the city labor links.

Types of labor links:

1. Amalgamation – is characterized by integration of two or more nodes, maintaining and supplementing stable functions.

$$Y_1^I + {}^{II}Y = Y_2^*Y$$

2. Merger – more significant link takes over less active one. Thus, the area and vectors of movement don't change.

$$Y_1^I + {}^{II}Y = Y_1^{I+II}$$

3. Opposite – when labor links are integrated their number increases exponentially.

$$Y_1^I + {}^{II}Y = Y_1^I Y_2^{II} Y_3^{III} \dots$$

Nature of labor links:

1. Disintegration is defined as the ratio of the total area of concentration of all parts of labor nodes in their total volume.

2. The focus – generalization associated with anticipation of observations and experiments results on the basis of empirical data. These empirical data "lead" to general, there fore generalization is considered as expedient truth or empirical laws.

3. Orientation – a choice of one class system of coordinates interconnected, in some sense, "positively".

Each system specifies orientation, defining a class to which it belongs.

It is described by the term "in and counterclockwise directions". Dependence of a labor skeleton frame in urban space (Fig. 2).

Depends on:

- labor potential of population (lpp),
- multifunctionality of country employment categories (mec),
- finance (f).

## CONCLUSIONS

The socio-political and socio- economic changes in the country have led to changes in

city planning concept, aiming professionals at search of new ways of city management.

Democratization of society formally invalid city-dwellers into the process of improvement of living environment.

Change of rules of public activity and a choice of homogeneous direction of vectors of city development, led to conservation of systems and immersions of the city in the closed trajectory with cycle being repeated regardless of geopolitical changes in the country. As we see, labor is very important factor in formation of urban environment. Thanks to a labor force, the population has work places which allow to realize talents and desire to produce goods which in turn stimulate market and economic relations and comfortable climate in the country in gen-

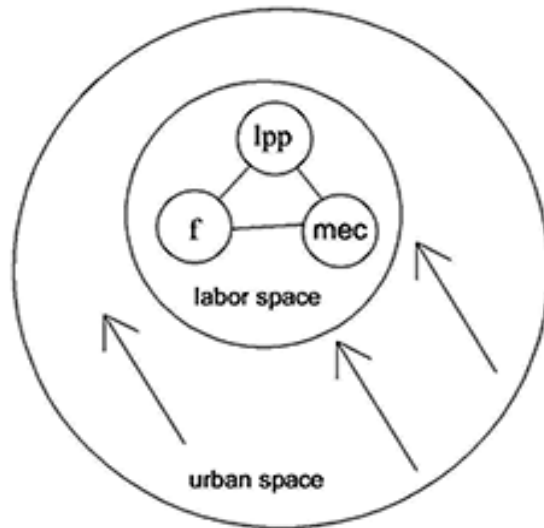

Fig. 2. Dependence of a labor skeleton frame in urban space

eral.

The labor skeleton frame of the city influences further orientation of development of functional and planning structure of the city. Each element of a labor skeleton frame should maintain integrity in the urban space and be connected to other elements of the urban framework.

Each part of the city labor skeleton frame should provide a special mode of use and, thereby, to preserve the functionality and rationality against the city background.



REFERENCES

1. **Glazychev V., 2011.** City without Borders. The territory of the future 400. (in Russian).
2. **David G. Shane., 2005.** Recombinant Urbanism, John Willey & Sons Ltd, UK, 344.
3. **Demin N., 1991.** Managing the development of urban systems. Kiev, Budivel'nik, 184. (in Russian).
4. **Jane Jacobs., 1961.** The Death and Life of Great American Cities, New York Random House, 458.
5. **Didyk V., Pavliv A., 2003.** Planning Cities, Lviv, 408. (in Ukrainian).
6. **Iodo I., 1983.** Foundation Urban Development. Theory and Methodology., Minsk, "High School", 199. (in Russian).
7. **Kevin Lynch A., 1981.** Theory of Good City Form, Cambridge, MIT Press, 514.
8. **Klyushnychenko E., 2003.** City Management: Textbook for students. Higher teaching. Book mark, Kyiv, National University of Construction and Architecture, Kiev, KNUCA, 326. (in Ukrainian).
9. **Kositsky Y., 2005.** Urban planning and territorial planning. Architectural and planning development of cities., Moscow Architecture-C, 54. (in Russian).
10. **Krasheninnikov A., 2005.** Urban development's identical development. Research experience of Western countries, Moscow, Architecture, 112. (in Russian).
11. **Ositnyanko A., 2001.** City Development Planning: Monograph, Kiev, KNUCA, 460. (in Ukrainian).
12. **Pleshkanovska A. 2005.** Functional organization planning and organization of the use of urban areas, Kyiv, Urban Institute, 190. (in Ukrainian).
13. **Pleshkanovskaya A., Savchenko E., 2011.** Cities and era, Kiev, Logos, 230 (in Russian).
14. **Polyakov N., 1965.** Basics of designing planning and configuration of cities. Moscow, 232. (in Russian).
15. **Filvarov G., 1983.** Socio-spatial organization of the industrial complex of a large city. – Kiev Budivel'nik, 255. (in Russian).
16. **Elzbieta Przesmycka, Ewa Pol., 2014.** Wooden architecture in small town planning in lublin region – state of preservation. Teka Kom. Arch. Urb. Stud. Krajobr. OL PAN, X-1, 33-40.
17. **Prusov D. Badakh V., 2013.** Principles for municipal facilities reconstruction based stability assessment methodology. MOTROL, Vol 15-5, 31-34. (in Russian).
18. **Lyudmila Ryabicheva, Yuri Nikitin, Irina Belyanskaya, 2012.** Production of copper powder from electrolysis waste products. Teka. commission of motorization and energetics in agriculture, Vol. 12, 253-258.
19. **Oleg Pogorelov, 2012.** Outline of a theory of semantic information and misinformation. Teka. commission of motorization and energetics in agriculture, Vol. 12, 210-217.
20. **Vitaliy Danich, Svitlana Shevchenko, 2012.** Models of the dynamics of the information-management architectures of the coal industry enterprises. Teka. commission of motorization and energetics in agriculture, Vol. 12, 31-35.

ТРУДОВОЙ КАРКАС КАК ФУНКЦИОНАЛЬНО-ПРОСТРАНСТВЕННАЯ СИСТЕМА ОРГАНИЗАЦИИ ГОРОДА

**Аннотация.** Модели мест локализации труда зарождались уже в античных городах и городах периода возрождения.

Закономерности геометрических зависимостей прослеживаются во многих теориях городов. Важным критерием качества планировочной структуры города является критерий среднего время поездки к основным местам работы.

**Ключевые слова:** трудовой каркас города, локализация мест работы, трудовые связи города, система трудовых связей.



## The solar component in the context of the inhabited areas microclimate regulation

*Iryna Koziatnyk*

Kyiv National University of Construction and Architecture  
Povitroflotskyi prosp., 31, Kyiv, Ukraine, 03680, e-mail: lumus@ukr.net

**Summary.** Summer overheated modern city deteriorates living conditions in it. For this purpose, the climate formation is considered in three adjacent spatial levels: macroclimate of geographical area; mesoclimate of a certain location (southern slope of the mountain, river valley, the sea coast); microclimate of two-meter surface layer (at the level of the human body). These levels of different spatial scale have similar mechanisms of climate formation. The radiation temperature and wind conditions of the area are the main causes of the overheating. The specified information proposes to research the solar radiation and the surfaces to accumulate it. The urban landscape is predominated over by the surface, which significantly accumulates heat. Hence the surface layer of air in the city receives three times more heat than in the natural environment. Thus, microclimate is formed in the streets, squares, in a housing estate and city parks under the natural and city planning factors. The found that for balancing and softening of microclimate conditions for living and of effective impact on the heat, humidity and aeration regime of the modern city, it is desirable to achieve a ratio of 1:1 between its planting and artificial surfaces.

**Key words:** climate, insolation, residential area, architectural and planning regulations, environmental barrierless environment.

### INTRODUCTION

A modern stage of global development is defined by hastily growing cities, population conurbation, agglomerating transport, industry, noxious emissions in the environment. Climate warming and the said global tendencies impair the urban living conditions,

while in 2008, according to the UN, 50% of the planet population lived in cities, about 70% - in Ukraine. In the said context, architecture and city development should contribute to resolution of a problem to provide comfort for human existence. Here, of use can be a positive experience of modern architecture – one of the “most illustrative and materialized manifestation of the social spiritual life” [1].

In the ambient environment, continuous in time and space, residential areas and dwelling are formed influenced by interaction of energy-mass systems, irregularly distributed on the land surface. This is primarily the natural climate of a certain locality. City development objects, transforming the energy and mass flow, create a new environment, where a local microclimate is formed. In the course of vital activity, people move from one environment into another. Thereat, influenced by a beneficial effect of a natural habitat, they try to regulate the urban environment accordingly, too. People’s reactions related to environmental changes, especially when it’s hot in summer, is mostly physiological. That’s why almost all countries – members of the World Meteorological Organization (WMO) – have prepared National reports regarding climatic changes, including on peculiarities of these changes’ effects on public health. These countries have also prepared National action plans to reduce risks related to effects of the said changes. Thus, in France, where over

35 thousand people died due to the 2006 heat, a special action plan has been issued envisaging creation of special recreation rooms for elderly people with comfortable microclimate, and propaganda of protective measures during summer overheating [2, 3, 4].

Climatic change becomes more and more appreciable adverse environmental factor, significantly and negatively affecting the comfort of people's stay in urban conditions in summer. When it is hot, public mortality rate is growing, especially among elderly population [2, 3]. According to Ukrainian scientists' forecasts, in 2010-2060, atmospheric temperature during the warm semester in Ukraine will rise, while the amount of precipitations and humidity factors will reduce [5]. Ukrainian legislation defines city planning as activities to create and maintain a sound human living environment, providing permanent, social, economically and environmentally balanced development of inhabited localities and adjacent territories, nature conservancy and rational nature management. Therefore, of especial significance is search of the corresponding architectural and planning measures enabling local alleviation of microclimate within limits perceptible for a man [6, point 10.31]. In this context, there emerges a necessity to generalize microclimate formation factors for residential areas and warmth-sensing indicators that would allow assessing the degree of thermal discomfort.

It should be mentioned that as regards formation of a comfortable and ecologically barrier-free environment, traditional microclimate division into "external" – of residential areas and "internal" – indoors, is not essential as people move freely from one space to another. Yet, while indoors or in vehicles the said matter is to some extent regulated by technical climate control means, in terms of near-house areas this issue still remains topical.

#### PROBLEM FORMULATION

Groups of buildings, underlying surface (verdured, paved, inundated), sunlight, radia-

tion, wind flows, temperature etc. interact in urban environment. Such agglomeration both creates a protective system of human existence within nature, providing its own form of a changed environment – city microclimate, and dissociates it from nature. Surrounded by buildings, people are affected by the changed environment and city in general [7].

Architecture and city development are important landmarks of human development. Public mental and physical health depends on the coziness, broadly speaking, of a city, building or structure, on the extent of harmony in their connection with the natural habitat. Under conditions of climatic changes this issue becomes especially crucial.

In terms of architectural and city development ecology, this matter is connected to the Sun and solar radiation, being the first and the most important climate-forming (from Greek "klima" - land surface inclination towards the Sun [8]) factor and determines the nature of the artificial environment. A.I. Voeikov, prominent Russian meteorologist noted that the Sun is the first cause of all processes forming the climate and it has a decisive influence on formation of a comfortable environment for human existence, and architecture [9]. Historical and culturological background confirm that urban climate and microclimate issues have long attracted the attention of architects and city planners.

Vitruvius's works paid great attention to effect of climate and recommendations on its recording. It started with stating the place selection principles and city planning in order to avoid wind funnel formation, take into account southern winds and heat, air humidity. A full chapter was dedicated to climate as a deciding factor in determining the building style. Thoroughness of climate accounting is confirmed by his phrase that "...cities and buildings in the south should be designed and built according to warm climate, doing this quite differently in the north" [10]. He warns of solar radiation, reflected from dry land or water, due to which in a hot climate a build-

ing will be subject to “double sun”, speaks against building cities in valleys due to increased humidity, decreased aeration and sun rays reflection, creating excessive heat [7; 11, 12].

A direct consequence of climatic conditions are architectural peculiarities of cities in southern dry regions, which always were a kind of "self-shading structures", and buildings – of original "thermoses" with solid walls, scarce small windows, enclosed compact planning of courtyard and narrow lanes. Damp regions, on the contrary, are marked by free planning, “breathing” translucent walls, well-ventilated areas [10].

Alberte and Palladio believed that "...width of streets, height of buildings and sizes of windows should be determined taking into account the orientation and depth of premises...". Corbusier undertook a serious research of design issues and wrote of a necessity to use solar and wind influence as forming factors when planning cities, stating that "sun is an important material for an architect..." [10].

Wright used solar geometry in designing a number of buildings. Thus, in Sturges's buildings, eaves' sizes depended on degree of sun rays' inclination. Climate also ranked first in Gropius's design concept. Many of his works take into account degree of sun rays' inclination in various periods of the year.

Today, all cities of the world have glass facades with light curtain walls, taking no account of local climatic manifestations. Later, Corbusier himself ascertained that in summer one should fight "...disastrous inrush of sun". He persuaded the committee of architects in 1933 in Athens to approve city development principles with regard to the fact that "urban planning materials are: sun, space, vegetation, steel and concrete, just in this strict order and hierarchy" [5, 11].

A major part of Rapoport's works is dedicated to consideration of natural surroundings, climate and social technology as deciding factors in selecting a building shape. He highlights that when forms and even structures are transferred unchanged from one

climate to another, there are often incorrect, in terms of climate, constructions and space. Space language should provide basic notions of external and internal environment and should reflect their non-separability. In this context, scientific analysis of climate is of great importance. However, today architectural developments and planning still lack scientific methods of using academic climatic data [7].

External climate, internal environment of buildings and structures, and human response thereto are interconnected. The main means of people's adaptation to environmental changes, depending on location – in- or outdoors – is clothes, while the space of their stay is integral. Among other changing characteristics, such space has thermal ones. As influenced by energy and mass, certain conditions are created in any point of space, depending on radiation and convectional characteristics of the area. Radiation conditions of residential areas is determined by climatic factors and nature of landscape, presence of natural or artificial objects, type of development [7].

Due to Galileo having invented the thermometer (1593) and Torricelli – the barometer (1644), it became possible to measure two main microclimate parameters - temperature and pressure. Results of measurements initiated in 1806 in cities around London and published by Howard in 1818 showed material dissimilitude of urban microclimate [7, 10].

As previously mentioned, prominent architects Vitruvius and Alberte not only had a professional command of methods of assessing microclimate, insolation and sunlight protection, but also improved and enhanced such skills. Suffice it to remember Vitruvius's famous “Sun's analemma”, forming the basis of all modern graphics for insolation and sunlight protection estimation [10].

Key climatic factors affecting a city development solution are radiation-temperature and wind pattern of the area. Analysis of radiation-temperature conditions envisages research of direct solar radiation intensity giv-

en various atmosphere transparency, and surfaces having various orientation [13].

An important factor of microclimate formation is insolation (from Latin – put to sun), which in turn is total solar radiation of surfaces and spaces. Insolation has dual effect on the man and the environment. It is beneficial on a sanitary-hygienic viewpoint, and thus economically profitable. Then, it is necessary to provide sunlight access to urban development. Yet, it causes light discomfort and overheat as well [13].

Radiation and insolation patterns are determined by total solar radiation, consisting of direct solar radiation produced immediately by the sun, diffused - produced by the whole horizon; shortwave solar radiation reflected by surfaces, and long-wave (thermal) radiation of heated surfaces [13]. Intensity of radiation emitted and reflected by the surface, radius of its effect are determined by the quantity of received solar radiation, and this surface's ability to reflect it (albedo). Intensity of vertical surface radiation is determined by its orientation. Thus, if we take radiation of a south-oriented surface as 100 %, for east and west surfaces it will be 130 %; east northwest and west northwest - 128 %; east southeast and west southeast - 137 %; northwest and northeast - 106 %; north northeast and north northwest - 85%; north - 65% [12]. Therefore, the walls facing east southeast and west southeast are subject to most radiation.

In southern cities, less favorable conditions exist for walls turned to the west and southwest, as great intensity of their radiation is usually connected with the highest daily atmospheric temperatures. Therefore, these walls have the highest surface temperature as well. A difference between surface temperatures of the south- and west-oriented walls at the time of their maximum radiation may be up to 6°C. The effect of surface-reflected radiation in southern cities develops on 4-5 m of the distance from the surface at southeast and south orientation; – 7-8 m at southwest; - 9-10 m at west; – 5-6 at northwest. The reach of heated surfaces' thermal long-wave radia-

tion is somewhat greater. Thus, at western orientation it reaches 15-16 m [11; 12, 10].

An idea of insolation standardization emerged in late 19th century. It was confirmed in Erisman's research findings - bactericidal effect of direct solar radiation on pathogenic bacteria's reactivation depending on ultraviolet radiation doses accessing residential premises. Due to this research, insolation standards were first set in Russia in the 1940-s (V.K. Belikova, N.M. Dantsig) – starting with 3 hours of direct solar insulations, this standard was later differentiated depending on a geographical latitude of the area [14]. The first principle of the previously mentioned “Athenian Charter”, setting forth the fundamentals of city development, was full provision of healthy dwelling for people, namely, space, fresh air and sun [15].

Direct solar radiation is much more intensive than diffused and reflected so it has the decisive role in assessing insolation distribution in qualitative and quantitative indicators in built-up areas and premises. Direct solar radiation in urban development is regulated by existing sanitary norms for insolation and the relevant paragraphs of the State Construction Norms (SCN) [6].

According to the sanitary and zoning standards valid in Ukraine (Sanitary Rules and Norms (SRN) 2.2.1/2.1.1.1076-01, SCN 360-92\*\*), location and orientation of residential and public buildings, preschool institutions, comprehensive schools should provide insolation duration in residential premises and areas, determined by sanitary standards for a certain period of time in hours, in accordance with regulatory requirements for each category of objects and areas for the period from 22 March till 22 September [6, point 10.30]. Standardization is performed with regard to climatic peculiarities of the design area and nature of development. Normative requirements are achieved by corresponding location, orientation, planning of buildings and areas. For the purpose of insolation accounting in architectural design and city development planning, it is defined using various graphical methods,

physical simulation, analytical estimation and computer programs [14].

## METHODS OF EVALUATION

Valid insolation standards are based on research of insolation length for premises, conforming to the mean annual dose of total solar radiation. As regards territory, such researches are few and they are mostly sanitary-hygienic and engineering-oriented, aiming to ensure a necessary minimum of solar radiation in residential areas. Their architectural planning standardization should be aimed at providing comfort of human existence in modern cities and regarding regulation of summer overheating – at preventing temperatures crossing the admissible maximum? But what is this maximum?

Works by B. Dunayev, D. Maslennikov, L. Orlova, O. Sergeychuk made a great contribution in methods of insolation assessment [10, 12]. At the Chair of City Construction of Kazan University L. Orlovska conducted a research regarding determination of radiation conditions assessment indicators in residential development territory in terms of the necessary minimum provision. These were energy indicators based on accounting of total radiation doses. It was determined that in shielding development spaces a reliable comparative assessment of the built-up area radiation conditions may only be received based on analysis of yearly and season radiation doses. Regularities of solar radiation exposure in annual cycles allowed us determining a formation mechanism of zones with various degrees of area shielding, limit (by technical-economic indicators) gaps between tower blocks - 1h and lengthy - 2h (where h is building height), limit of insufficient insolation zone by shielding degree isoline  $\eta=0,5$  ( $\eta$  - shielding degree) as estimated value, and determining corresponding astronomically possible yearly and season radiation doses for the area. The examined method of limits determination for insufficient insolation zones allows obtaining a graphical image of area insolation for the year and to implement

the necessary insolation indicators according to SCN [16].

Radiation condition assessment includes background characteristics as well: flow intensity of direct and diffused radiation affecting horizontal and vertical surfaces, as well as analysis of radiation flow transformation inside the city - solar radiation influencing inclined surfaces of various orientation, mutual radiation of development elements. Near insulated planes temperature and radiation conditions in summer become much worse, increasing the urban environment overheating. Intensity of emitted and reflected radiation and distance of its adverse effect is determined by the quantity of received solar radiation, these surfaces' albedo [12].

Territorial radiation image may also be obtained by drawing an insolation map using B. Dunayev's insolation line [9]. The said method is as follows: a mesh of check points is set on a square grid in the residential development area; insolation duration value is determined for each of them and "shade envelopes" are built from buildings for each hour of the day, followed by tracing insolation duration isoline. There is a method of presenting insolation graphical image in the area by D. Maslennikov, based on use of DM-55 light surveyor, that allows determining insolation duration for any month and amount of energy received for a certain time interval, by applying a device with a corresponding scale on the development drawing [12]. Based on obtained maps, the place and degree of the territory thermal pattern's regulation are determined.

Heretofore, greater attention has been paid to residential insolation conditions and lesser - to insolation of areas. Main attention has been drawn to shape, construction and sizes of area lights in buildings, their orientation according to sides of the horizon, location with respect to windows of buildings elements (balconies, loggias, eaves, protrusions, screens, venetian blinds), surrounding residential and communal buildings. However, under summer overheating conditions, the issue of sunlight protection of territories, building walls, and structures from excessive insola-

tion becomes more topical. Especially important here becomes the problem of shading planes and spaces in residential development.

This requirement to arrangement of a continuous yet variable in time and space single environment for human existence in the city, though contradictory at first sight, should be taken into account both at planning organization of residential areas in general and at planning, landscape gardening and rehabilitation of its separate functional elements. Norms and rules for insolation provision at residential areas primarily concern places directly used by the public: children's playgrounds; sidewalks and alleys; swimming pool locations, gaming facilities, recreation benches etc. Normative insolation dose of separate space elements, as well as timing and necessary shading area under summer overhear conditions should be determined in accordance with these elements' functional purpose and operating mode [6, 12, 17].

#### ACTIVITIES REGULA

For the purpose of children UV irradiation, children's playgrounds should be insulated during morning hours and in the afternoon, especially during summer overhear, require sufficient shading. Therefore, the structure of such suncreening facility should create conditions preventing overhear of the body and at the same time providing maximum use of solar energy for medical purposes [10]. The said insolation pattern should also determine tree planting procedures along sidewalks depending on their orientation towards sides of the horizon. In observing the insolation pattern standards, subject to provision of sunlight protection of a sports ground, located in a residential development, one should take into account hours of its use after studies or work. Usually tree planting is envisaged with regard to ground shading in the afternoon. Planting sites and sorts of trees should be specified subject to leafage shade projections during hot hours [12].

Nowadays, these factors are especially significant in developing planning solutions

for residential areas. When tracing pedestrian routes, locating children's playgrounds, other spatial elements used by the public, it is necessary to take into account proximity of surfaces, reflecting or emitting solar radiation. Under environmental overhear conditions in combination with low wind speed (still-air conditions), there is a problem of ventilation intensification - "wind capture". Under such conditions, the development planning organization should ensure optimal ventilation terms for the residential area by rational organization of street and pedestrian route arrangement (orientation, profile), observing optimal correlation between built-up, paved, verdured and inundated surfaces. A variety of planning solutions as well as difference of natural climatic conditions of cities determine a necessity to search for optimal insolation and sun protection pattern for the residential area in each specific case [12].

As noted previously, besides direct sun rays (insolation), radiation reflected and emitted by surfaces is of great importance during planning arrangement of residential areas. Its role grows during hot season of the year due to high intensity of direct solar radiation. Limited access of sun rays to surfaces and spaces is reached due to corresponding use of development elements and small forms, microrelief, planting, aquatic areas, fountains, special structural devices - horizontal sun breakers along facade, vertical blinds, screens, eaves, balconies, preventing wall surface overhear [12, 18, 19]. Thus, for instance, swimming pools located at maximum insolation area absorb up to 5400 kcal/m<sup>2</sup>/day, and only about 600 kcal remain to increase atmospheric temperature [13]. An expedient means to reduce duration and quantity of house area insolation and decrease heat on underlying surface becomes separation of yard space with screens of twining plants or stripes of high-leafage broadleaf trees.

Architectural-planning measures of insolation regulation unite means related to development composition on the residential buildup general layout, planning of buildings and structures, land improvement. Architec-



tural-structural measure cover shading elements of buildings, sun-protective glass-ware and films, sun-protective stationary and mobile devices for territories. We may also distinguish a group of technical means providing artificial microclimate [10].

## CONCLUSIONS

In all terms (sanitary-hygienic, functional-planning, structural, esthetic, economic) sun-light protection is an integral and effective architectural element. In bioclimatic aspects of environmental factors important is comfort of human heat sensation. Vigorous activity of a man mainly occurs at daytime, so for city development it is more expedient to take into account the nature of bioclimatic conditions, typical of daytime. The said assessment methods and insolation regulation measures are crucial for daytime under summer overheat conditions.

Under existing conditions, requirements regarding improvement of human ambient environment returned methods and means based on efficient use of useful properties of natural components: sun, wind, water, vegetation. The above-mentioned meets environmental tasks and forms "new ecological architecture" (architectural bionic, solar architecture, climate forming architecture).

Now, when the urbanization process captured the world, the issue of harmonization between the society and nature for the purpose of preserving ecological balance and creating a favorable living environment for people becomes extremely topical.

## REFERENCES

1. **Bilokon Y., Fomin I., 2006.** Science and creativity in architecture. Kyiv, Logos, 6-8. (in Ukraine).
2. **Revich B., 2006.** Climate, air quality and health of Muscovites. Moscow, 5-8, 102-141. (in Russian).
3. **Vetrova N., 2013.** Ecological audit and ecological monitoring in environmental safety of a region. Motrol: kom. Mot. Energ. Roln., OL PAN, Vol.14-1, 80-85.
4. **Voloshkina O., Berezniiska J., 2014.** Development of Ukraine Territory Flooding Processes; Its Parameters and the Influence on the Environmental Safety Level. Motrol: kom. Mot. Energ. Roln., OL PAN, Vol.16-8.
5. **Sokolov I., Dolgikh E., Sokolova E., Mostovoy O., 2008.** The age-long cyclic main natural variability of environmental factors in the southeast of Ukraine. IV Int. Scientific Practical Conf. Environmental Security: Problems and Solutions. Kharkov, UNDIIEP, 98-102. (in Russian).
6. **The state building code 360-92 \*\*(SBC360-92 \*\*), 2002,** City Planning. Planning and development of urban and rural settlements. Kyiv, 60-67. (in Ukraine).
7. **Markus T., Morris E., 1985.** Buildings, climate and energy, translated from English. St. Petersburg, Gidrometeoizdat, 24-60. (in Russian).
8. **Kucheryavyi V., 2001.** Ecology of the cities: the textbook. Lviv, Svit. 239-241. (in Ukraine).
9. **Obolensky N., 1988.** Architecture and sun. Moscow, Stroiizdat, 10-11, 57-137. (in Russian).
10. **Litskevich V., Makrinenko L., Migalina I., 2007** Architectural physics, a textbook for higher education degree in Architecture. Moscow, Architecture-S, 7-10, 205-242. (in Russian).
11. **Bunin A., Savarenskaya T., 1979.** Urban art history, in 2 volumes. Moscow, Stroiizdat, Vol. 1, 6-8, 23-95. (in Russian).
12. **Chistyakova S., 1988.** Protecting the environment, a textbook for higher education degree in Architecture. Moscow, Stroiizdat, 210-217. (in Russian).
13. **Belousova, V., 1978.** Reference designer. Moscow, Stroiizdat, 42-59, 341-345. (in Russian).
14. **Ustinova, I., 2008.** Urban Environmental measures of microclimate inhabited areas, objectives and guidelines. Kyiv, KNUCA, 1-16 (in Ukraine).
15. **Repin, U., 2009,** Spatial city. Theory and Practice. Kyiv, "Phoenix", 80-83 (in Russian).
16. **Orlova, L., 1985.** The method of energy assessment and management of insolation in residential areas: summary of the thesis. Moscow, 1-24. (in Russian).
17. **(SRN) 2.2.1/2.1.1.1076-01, valid from 02.01.2002.** Hygienic requirements for insola-

tion and sun protection residential and public buildings and areas: Sanitary Rules and Norms. Moscow, Information and Publishing Center of Ministry of Health of Russia Nr 2002, 1-9.

18. **Kulikov T., Kazmina A., 2014.** Methods of arhitektural and konstruktion solutions and thermal effectIvenesi of buildings. Motrol: kom. Mot. Energ. Roln., OL PAN, Vol.16-5. (in Russian).
19. **Dvoretzky A., Klevets K., 2014.** Heat loss reduction of energy-efficient home by buffer areas. Motrol: kom. Mot. Energ. Roln., OL PAN, Vol.16-5.

#### СОЛНЕЧНАЯ СОСТАВЛЯЮЩАЯ В КОНТЕКСТЕ РЕГУЛИРОВАНИЯ МИКРОКЛИМАТА ЖИЛЫХ ТЕРРИТОРИЙ

**Аннотация.** Летний перегрев современного города ухудшает условия проживания в нем человека. Формирование климата города рассматривают сегодня на трех смежных пространственных уровнях: макроклимата географической зоны (лесостепь, полесье); мезоклимат определенного региона или места (морское побережье, долина реки, южный

склон горы); микроклимат на уровне организма человека (в двухметровом приземном слое). Эти уровни различной пространственной шкалы имеют схожие механизмы формирования климата. Основными факторами перегрева является радиационно-температурный и ветровой режим территории.

Предполагается исследование солнечной радиации и поверхностей, которые ее аккумулируют. Наземный слой воздуха в городе получает втрое больше тепла, чем в естественной среде. На улицах, площадях, в жилой застройке и парках города под влиянием природных и градостроительных факторов формируется свой микроклимат, а микроклиматические условия могут регулироваться и архитектурно-планировочными средствами. Для балансировки микроклиматических условий и эффективного воздействия на инсоляционный, тепловой, влажностный и аэрационный режимы современного города, желательно достичь пропорции 1:1 между его искусственными и озелененными поверхностями.

**Ключевые слова:** климат, инсоляция, жилая территория, архитектурно-планировочное регулирование, экологически безбарьерная среда.

## Systems of raising deep-water concretions

*Mykhailo Sukach*

Kyiv national university of construction and architecture  
Povitroflotskyi prosp., 31, Kyiv, Ukraine, 03680, e-mail: msukach@ua.fm

**Summary.** The systems of raising of hard minerals are considered from the sea-bottom, taking into account characteristics of the deposit, condition of the environment, technological and technical parameters of extracting of concretions. The given classification of the pipeline, wire-rope-bailer, off-line and combined systems of raising on the type of stream, mobility of the system of raising of concretions, amount of parallel streams of mountain mass and structural break of technological chain.

**Key words:** hard minerals, systems of raising, deep-water concretions, mountain mass.

### INTRODUCTION

Research, survey and survey work carried out over the past decade in the ocean, allowed to establish the prospects shelf zone and open ocean areas to detect deposits of solid minerals (SSM): Ore liquid dispersed noble metals and building materials. Specific role of water that covers the field and is a source of many valuable chemical elements, called liquid ore.

The peculiarity of the conditions of occurrence of TCC deposits characterized by type of minerals and ore bodies, genesis, deep water layer, and the distance from the shore or industrial developed areas. Under these conditions, the system is particularly important lifting the rock mass composed of floating exploration or exploitation ocean technological complex. The type of lifting determines the choice of design and

procedures for the use of other systems, subsystems and complex as a whole.

The system of recovery of solid minerals depends strongly on the depth of water, is associated with lifting height range transport and vertical rock mass, and is the primary choice in the type and capacity of the drive weight and size and design of load funds, and hence displacement craft [1].

It is advisable to subdivide lifting systems according to specific areas of the hypsometric curve, reflecting the geomorphological features of the structure of the ocean floor: shallow and coastal zone (depth 50 m); small depths and shelf (200...600 m); average depth, continental slopes (2000 m); greater depths and areas of mid-ocean ridges (4000 m); and lodges deep ocean (4000...6000 m).

The choice of lifting is also determined by the type and properties of underwater mineral deposits corresponding to the characteristic depth of the occurrence. The deposits are divided into: sand and gravel alluvial marine shelf areas in the seas and oceans (depth 200...600 m); metalliferous muds and brines bottom depressions (up to 2000...2500 m); cortical ore guyot (3000 m); sulphide ore mid-ocean ridges (4000 m); deep-sea nodules (4000...6000 m).

## PURPOSE OF WORK

Purpose of work – systematization schemes of lifting nodules during their extraction. The most difficult to select and justify is the lifting system for nodules that occur under conditions of high pressure and aggressive environment countervailing currents, low temperature, low water clarity with a typical multilayer deposition of ore fines particle size of several centimeters [2]. The basis of the scheme of systematization lifting nodules (SEC) is their technological properties.

## SYSTEMS OF LIFTING NODULES

The main technological properties of IBS include: type of rock mass flux, spatial mobility of lifting, the number of streams and constructive dissolubility technology chain apparatus. The combination of these properties quantitatively characterizes the opportunity to achieve specified performance, depth, height, raising the level of energy and capital costs, loss of minerals, the stability of the process in operation, production flexibility and agility of recovery.

1. *By the type of flow*; diagrams of lifting nodules are divided into systems with continuous and discrete flow of the rock mass, which lift (Fig. 1).

Continuous – flow pipeline IBS type (pump, airlift, ejector, the empty recesses element double piped with floating stream of stimuli of different modifications) have fundamental limitations in performance with a range of values – 4...5 million tons per year for one set. Such performance can be achieved by increasing the quantitative characteristics of the system: the diameter of the pipe, flow rates, pump power or the performance of compressors etc. The limit specifies the technical characteristics of lifting units and other systems and subsystems, such as the fact that it is impossible to achieve the specified performance collection nodules. In this design, the number of units and the order of

interaction of raising remain the same for any given performance.

The structural type and main technical and economic indicators of IBS various designs with discrete flow rock mass is stored in the specified range for which the system can be divided into small portions (with unit weight lifted load, up to 1 ton), tonnage (1...100 ton) medium-duty (100...1000 ton) and large- (> 1000 ton). These ranges roughly determine the limits of rational use of discrete flow and characteristic structural features. For example, for the extractive complexes of autonomous type (with submarine pop-up vehicles) a transition from low-tonnage to the middle-tonnage systems of getting up is possible at creation fundamentally of more mighty energy sources, and to large-tonnage – after the radical improvement of the systems of buoyancy.

Concept of continuity and discreteness in combined lifting systems applied separately to each of the processing chain formed by aggregates of one structural type.

2. *The mobility of lifting nodules* – the most important technological feature that depends on the combination of the properties of other elements ocean technological complex and the adopted excavation of nodules. The distinctive feature – the speed of the lifting system as a whole with respect to the bottom during removal. Increase speed is undesirable as rising energy costs, the complexity of managing transient conditions, the mechanical load on the structure of aggregates that are operative strength close to the boundary. In addition, the increased speed of movement ocean technological complex usually difficult navigation safety and increases loss of extraction.

The degree of mobility of lifting nodules can be divided into still in the process of removing, slow-moving (up to 0,3 m/s) and fast moving (0,3...3 m/s). Quantification of mobility limits driven by strong growth in its hydrodynamic resistance.

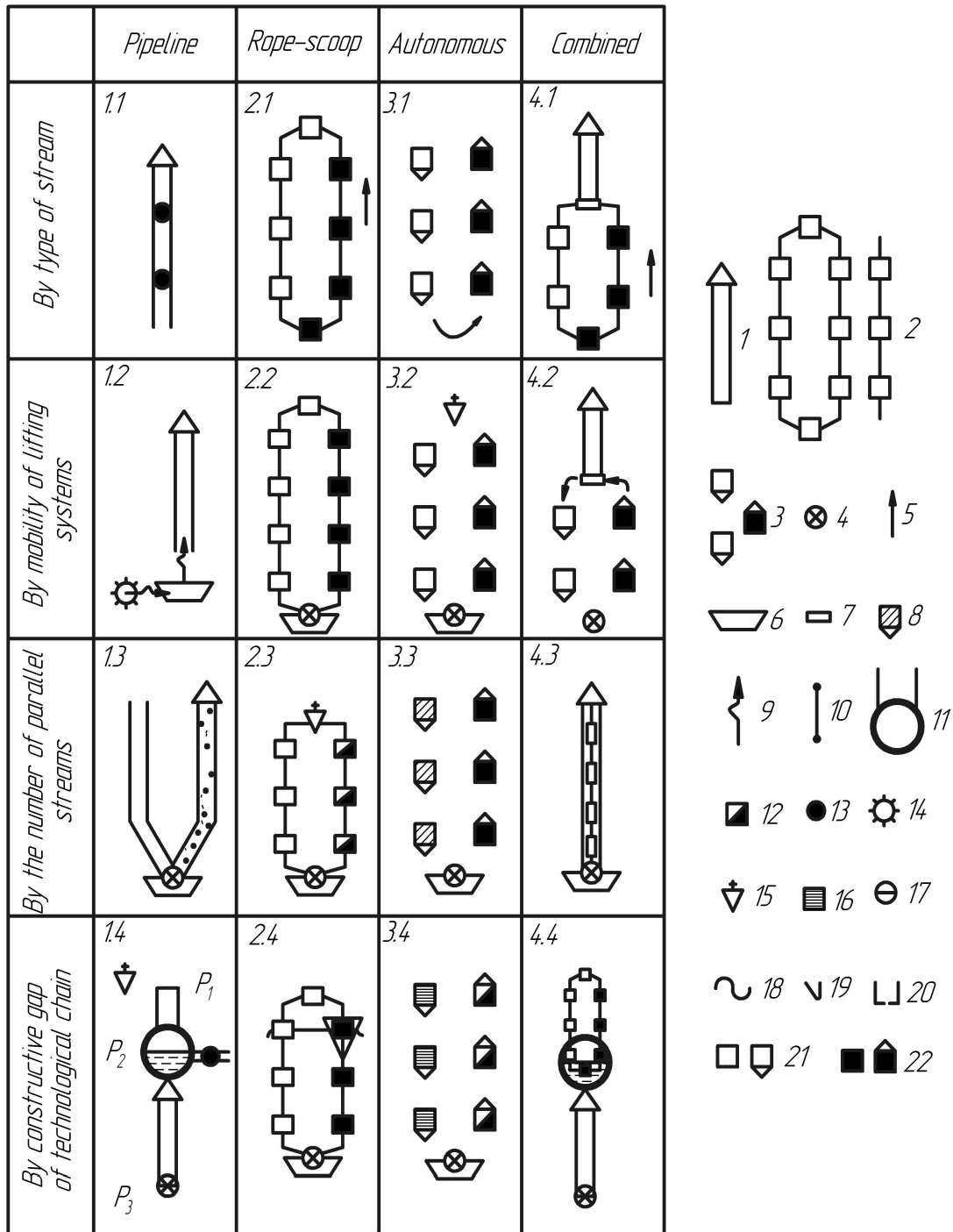

**Fig. 1.** Lifting schemes of solid minerals:

1 – pipe, 2 – rope, 3 – autonomous, 4 – unit fee, 5 – direction of the flow of the rock mass, 6 – chassis, 7 – intermediate tank, 8 – the capacity of the ballast, 9 – flexible pipe, 10 – rope, 11 – buried an empty element, 12 – with gas-filled container and cargo compartment, 13 – drum pump, 14 – up, 15 – craft, 16 – chemical element of the filler, 17 – the capacity of the pulp, 18 – wave energy, 19 – bunker, 20 – Mechanical grippers, 21–22 – capacity, 21 – loaded, 22 – blank

The mobility of lifting in aggregate form reflects the level of energy, loss of minerals, reliability and stability of exploration and development activities. All these parameters vary in inverse proportion to the speed of movement of frontal lifting and ultimately meets the changing aggregate costs of removal, that the criterion of choosing the optimal technological IBS. Therefore, analysis of mobility can be used for rapid qualitative

assessment, comparison and selection lines of development schemes and facilities ocean technological complex.

3. *Number of parallel streams of rock mass* in the technological scheme reflects its compliance with safety requirements, production flexibility, mobility, stability during temporary worsening conditions and suitability of the system to build (if necessary) performance. Obviously, the lifting system with several structurally decorated rock mass flows will satisfy these requirements in the best way, but have a high cost and other disadvantages. A part form single-threaded and multi-threaded streaming potential site flow diagrams, Multithreaded efficiently perform only in areas with the most difficult conditions with reduced performance or reliability units.

4. *Constructive dissolubility processing chain aggregates* characterizing compliance of the scheme marine operating conditions. An important feature here is the presence of continuous mechanical coupling between aggregates processing chain, which has a negative impact on operating system reliability and stability of the process and makes it difficult to ensure the safety of the system. Quantitatively, the joint effect of threading and constructive gaps expressed value of the coefficient of efficiency of working time ocean technological complex.

Lifting schemes of nodules can be divided into inseparable with permanent mechanical connection between the aggregates extraction and craft, and discontinuous, having no such connection in all or part of depth recovery. Discontinuous system in the first case related to autonomous, the second – to the

combination as lifting devices connect different structural types. Systems of lifting unbroken chain units can also be combined if units include lifting of different structural types.

Dissolubility processing chain increases its flexibility and production flexibility, but in the cases involving temporary connection of underwater units (i.e., their docking), significantly complicates the design and operation of such systems and reduces the stability of the process.

## DISCUSSION AND REFERENCES

As part of the ocean technological complex lifting scheme can be used as nodules with ground gear (or machine) – unit cleaning (Chart 1.2 – 4.2 on Fig.1) and without (Chart 1.1 – 4.1 on Fig.1).

Economic indicators rise SEC using different agents of flow in piping systems or devices of discrete flow systems, such as light liquids, gases, light elements, ballast material (Chart Fig. 1.3 – 4.3 on Fig.1).

Techno-economic performance of different technologies of lifting nodules can be significantly enhanced by the energy of the sea (classified important features), such as: pressure drop across the system with empty recesses element of wave energy in the chair of container lifting systems, the potential energy of inert materials being substituted for utility deposits in the aggregate collection of discrete flow systems, lifting (Chart Fig. 1.4 – 4.4 on Fig.1).

Structural classification features of deep nodules lifting scheme is closely related to technological parameters, causing the appearance of lifting and ocean technological complex as a whole and, to a large extent, the number and characteristics of major units and technical-economic indicators of the complex.

## CONCLUSIONS

1. Promising useful raw material for extraction of manganese, nickel, copper, cobalt and others. Polymetallic concretions occur in the central regions of the ocean floor. The terms of their occurrence at a depth of 4000...6000 m are complex and unique. Therefore, the most important this is the raising of nodules floating in intelligence or operational enterprise.

2. Lifting systems are divided into pipeline, chair scoop, standalone and combined with the unit picking up without it. Their effectiveness is enhanced by the use of different pathogens flow and seas.

3. Signs of systematization schemes lifting nodules are: continuity (in hydraulic) and discrete (in the rope-scoop and autonomous) flow of raw material; degree of mobility of the complex system recovery and the number of concurrent streams and constructive dissolubility technology chain apparatus.

## REFERENCES

1. **Bakurov G., 1988.** Ships for deep-water mountain geological researches. Moscow, Shipbuilding, № 3, 12-16.
2. **Ferromanganese concretions of the central part of the Pacific ocean, 1986.** Under editing I.O. Murdmaa, N.C. Skorniakova. Moscow, Nauka, 344.
3. **Fouco I., 1982.** Modern state of technique of booty of deep-water ferrimanganese concretions. VTZP, Nr E-41418, Moscow, 28.12.83, ist. Fusen, Vol.29, 99-167.
4. **Nurok G., Brujakin Yu., Bubis Yu. and other., 1979.** Mining technology from the bottom of lakes, seas and oceans. Moscow, Nedra, 381.
5. **Ogorodnikov С.П., 1986.** Hydromechanization of development of soils. Moscow, Stroyizdat, 256.
6. **Paschkin V., Iakovlev P., Cokolov V., 1999.** Dredging, turning and gidromechanized works: train aid. Odessa, Astroprint, 432.
7. **Schniukov E., Ziborov A., 2004.** Mineral riches of the Black sea. Kyiv, NANU, 279.
8. **Shkaryvsky G., 2014.** Estimation of influence structurally of layout charts of power facilities on completing of aggregates on their base. Motrol: kom. Mot. Energ. Roln., OL PAN, Vol.16, No 3, 165-171.
9. **Sukach M., 2004.** Booty and portage of ocean metal of containing crusts. Industrial hydraulic and pneumatic, Vol.3(9), 8-11.
10. **Sukach M., 2004.** Workflows of deep machines. Kyiv, Naukova dumka, 364.
11. **Sukach M., 2012.** Deep-water technique and technology for development of minerals of the World ocean. Labours VI ISTK "Energia-2012", Simferopol-Alupka, 9.
12. **Sukach M., 2012.** Problems of booty of hard minerals from the bottom of the World ocean. Motrol: kom. Mot. Energ. Roln., OL PAN, Vol.14 (1), 116-122.
13. **Sukach M., 2013.** Prospects of разработки of marine deposits of mineral raw material. Innovations in science are innovations in education: collection of labours. JuRGPU (NPI), Novocherkassk, 285-291.
14. **Sukach M., 2013.** Research and development deep-water booty technique. Gіrničì, budivelnì, dorozhni ta meliorativni mašini [Mining, constructional, road and melioration machines], Vol.82, 57-65.
15. **Sukach M., Lysak S., Sosnowski S., 2010.** Kinematic analysis of trencher's working process. TEKA: kom. Mot. Energ. Roln., OL PAN, Vol. X, 425-431.
16. **Sukach M., Lytvynenko I., Bondar D., 2009.** System of the automated management and measuring of parameters of technological processes. Motrol: kom. Mot. Energ. Roln., OL PAN, Vol.11B, 186-189.
17. **Technical instructions on the production of the marine dredging, 1986.** ПД 31.74.08-85. Moscow, W/S Mortechninform reklama, 172.
18. **Ziborov A., 2006.** To obtain or not obtain the black Sea sapropels in Ukraine. Geology and minerals of the World ocean, Vol.1, 92-99.
19. **Ziborov A., 2008.** Prospects and tasks of mastering of marine deposits of mineral raw material. Geology and minerals of the World ocean, Vol.3, 5-18.

СИСТЕМЫ ПОДЪЕМА  
ГЛУБОКОВОДНЫХ КОНКРЕЦИЙ

**Аннотация.** Рассмотрены системы подъема твердых полезных ископаемых из морского дна, с учетом характеристик месторождения, условий окружающей среды,

технологических и технических параметров добычи конкреций. Дана классификация трубопроводных, канатно-черпаковых, автономных и комбинированных систем подъема по виду потока, подвижности системы подъема конкреций, количеству

параллельных потоков горной массы и конструктивной разрывности технологической цепи.

**Ключевые слова:** твердые полезные ископаемые, системы подъема, глубоководные конкреции, горная масса.



## Defining the basic parameters of vibration settings for sealing horizontal surfaces

*Mykola Ruchynskyy, Andriy Zapryvoda*

Kyiv National University of Construction and Architecture  
Povitroflotskyy prosp., 31, Kyiv, Ukraine, 03680, e-mail: [ustylug@i.ua](mailto:ustylug@i.ua)

**Summary.** Are examined and defined pattern vibratory motion to form horizontal surfaces on the basis of the account of wave phenomena and bias voltages. Given numerical values screeds and rheological characteristics of sealing concrete.

Based on the analysis of the energy balance, motion qualities limits are defined. Analytical dependences for the estimation of main parameters of the effective vibroimpact mode are suggested as well as the motion stability layout of the analyzed system is cited.

**Key words:** concrete mix, resonance, seals, vibration.

### INTRODUCTION

In modern construction fate cast-frame method is increasingly used [1]. A large proportion of the implementation of this method is accompanied by the formation of horizontal surfaces where there is a problem of sealing. Of particular importance is the formation of horizontal surfaces in the arrangement of underground garages, units, installations and maintenance of the building etc. In this paper we solve the problem to study the dynamics of surface vehicles of considerable length ( $l > 2...3$  m) in terms of interaction with the manufacturing environment.

### PURPOSE OF WORK

Of surface compaction devoted a number of works [2-4]. In [2, 3] considered a discrete model of the concrete mix. Significant theoretical research based on wave theory Concrete mixture ramming surface vibration are given in [4, 5], which revealed the basic laws of motion of this class of machines. The results [4, 5] is much deeper insight into the process of consolidation. Soil compaction over Vibration rammer dedicated works [6, 7]. Based on the results of the cited studies [4-7], a similar problem is solved based on the model of the environment, taking into account the shear stress [8, 9], which is one of the effective compaction.

### RESULTS AND DISCUSSION

Methodology provides premise that the concrete mixture, which is under the lining for the device horizontal surfaces are quasi homogeneous body. It is assumed that the concrete mixture is modeled flexible rod length  $h$ . Consider that at the core of the force of gravity, which causes it to longitudinal oscillations.

If we denote by  $u(x, t)$  displacement of the rod cross-section of abscissa  $x$  at time  $t$ , then the differential equation of forced oscillations of "lining - a layer of concrete

mix" considering energy dissipation is as follows:

$$\frac{\partial^2 u(x,t)}{\partial x^2} = \frac{1}{c^2(1+i\gamma)} \frac{\partial^2 u(x,t)}{dt^2} + g, \quad (1)$$

where  $\frac{\partial^2 u}{dt^2}$  and  $\frac{\partial^2 u}{dx^2}$  - under acceleration

mixture and the second derivative of strain

$\varepsilon = \frac{\partial u(x,t)}{dx}$ ;  $i = \sqrt{-1}$ ;  $c$  - velocity of longi-

tudinal waves propagating in a layer of concrete mixture having elastic modulus  $E$

and density  $\rho$ ,  $c = \sqrt{\frac{E}{\rho}}$ ;  $\gamma$  - loss factor,

which characterizes the energy dissipation;

$\gamma = \frac{\Delta W}{2\pi \cdot W}$ ;  $\Delta W$  - energy absorbed by the

basic layer of concrete mixture over period;

$W$  - potential energy of deformation of this layer;  $g$  - acceleration due to gravity.

Assuming that the concrete mix is an environment in which the generated elastic shear wave, and the surface of the lining is not separated from the surface layer of the concrete mix, the boundary conditions can be represented as follows:

$$u|_{x=h} = 0; u|_{x=0} = x_0 \sin(\omega t), \quad (2)$$

where:  $x_0 \equiv A$  - the amplitude of oscillation of the working body lining,  $\omega$  - circular frequency of its oscillations.

We assume that the initial displacement and initial velocity is zero, then the initial conditions can be summarized as follows:

$$u|_{t=0} = 0, \frac{\partial y}{\partial t}|_{t=0} = 0 \quad (3)$$

To address the problem (1) - (2) can not apply the Fourier method, since the boundary conditions (3) uniform. But this problem is easily reduced to a problem with zero boundary conditions (in which you can apply the Fourier method).

Indeed, we introduce a supporting role:

$$\begin{aligned} w(x,t) &= x_0 \sin(\omega t) - x_0 \sin(\omega t) \frac{x}{h} \\ &= x_0 \sin(\omega t) \left(1 - \frac{x}{h}\right) \end{aligned} \quad (4)$$

It is clear that:

$$w|_{x=0} = x_0 \sin(\omega t), \quad w|_{x=h} = 0 \quad (5)$$

The problem is now looking as the sum of:

$$u(x,t) = v(x,t) + w(x,t), \quad (6)$$

where  $v(x,t)$  - new unknown function. Due to the boundary conditions (2), (5) and the initial conditions (3), the function  $v(x,t)$  must satisfy the boundary conditions:

$$v|_{x=0} = 0; \quad v|_{x=h} = 0, \quad (7)$$

and initial conditions:

$$v|_{t=0} = u|_{t=0} - w|_{t=0} = 0. \quad (8)$$

$$\begin{aligned} \frac{\partial v}{\partial t}|_{t=0} &= \frac{\partial u}{\partial t}|_{t=0} - \frac{\partial w}{\partial t}|_{t=0} = \\ &= -\omega x_0 + \omega x_0 \frac{x}{h} = -\omega x_0 \left(1 - \frac{x}{h}\right). \end{aligned} \quad (9)$$

Substituting now equation, we get:

$$\frac{\partial^2 v}{\partial t^2} = a^2 \frac{\partial^2 v}{\partial x^2} + g + a^2 \frac{\partial^2 w}{\partial x^2} - \frac{\partial^2 w}{\partial t^2} \quad (10)$$

or by virtue of (4),

$$\frac{\partial^2 v}{\partial t^2} = a^2 \frac{\partial^2 v}{\partial x^2} + \tilde{g}(x,t), \quad (11)$$

where:

$$\tilde{g}(x,t) = g - \omega^2 x_0 \sin(\omega t) \left(1 - \frac{x}{h}\right). \quad (12)$$

In (10) and (11) introduce the notation:

$$a^2 = c^2(1 + i\gamma). \quad (13)$$

Thus, we obtain the problem for the function  $v(x, t)$ :

$$\begin{cases} \frac{\partial^2 v}{\partial t^2} = a^2 \frac{\partial^2 v}{\partial x^2} + \tilde{g}(x, t), \\ v|_{x=0} = 0; \quad v|_{x=h} = 0, \\ v|_{t=0} = 0; \quad \left. \frac{\partial v}{\partial t} \right|_{t=0} = -\omega x_0 \left(1 - \frac{x}{h}\right), \end{cases} \quad (14)$$

We will seek a solution to this problem as the sum of:

$$v(x, t) = v_1(x, t) + v_2(x, t), \quad (15)$$

where  $v_1(x, t)$  is a solution of the inhomogeneous equation:

$$\frac{\partial^2 v_1}{\partial t^2} = a^2 \frac{\partial^2 v_1}{\partial x^2} + \tilde{g}(x, t). \quad (16)$$

Satisfying the boundary conditions:

$$v_1|_{x=0} = 0; \quad v_1|_{x=h} = 0, \quad (17)$$

and initial conditions:

$$v_1|_{t=0} = 0; \quad \left. \frac{\partial v_1}{\partial t} \right|_{t=0} = 0, \quad (18)$$

and  $v_2(x, t)$ , is a solution of a homogeneous equation:

$$\frac{\partial^2 v_2}{\partial t^2} = a^2 \frac{\partial^2 v_2}{\partial x^2}. \quad (19)$$

Meets the boundary conditions:

$$v_2|_{x=0} = 0; \quad v_2|_{x=h} = 0, \quad (20)$$

and initial conditions:

$$\begin{aligned} v_2|_{t=0} &= 0, \\ \left. \frac{\partial v_2}{\partial t} \right|_{t=0} &= -\omega x_0 \left(1 - \frac{x}{h}\right), \end{aligned} \quad (21)$$

Decision  $v_1(x, t)$  is the forced oscillation layer of concrete mixture, and oscillations

that occur under external exciting force, if the initial perturbations are absent.

Decision  $v_2(x, t)$ , is the free oscillation layer of concrete mixture, and fluctuations which occur only as a result of the initial perturbation.

Using [3], we have to  $v_2(x, t)$ :

$$\begin{cases} v_2(x, t) = \sum_{k=1}^{\infty} \left( a_k \cos\left\{ \frac{k\pi a t}{h} \right\} + b_k \times \right. \\ \left. \times \sin\left\{ \frac{k\pi a t}{h} \right\} \right) \sin\left\{ \frac{k\pi x}{h} \right\} \\ a_k \equiv 0, \quad b_k = \frac{2}{k\pi a} \times \\ \times \int_0^h \left\{ -\omega x_0 \left(1 - \frac{x}{h}\right) \right\} \sin\left\{ \frac{k\pi x}{h} \right\} dx. \end{cases} \quad (22)$$

For  $v_1(x, t)$  can find a solution in the form of the following series:

$$v_1(x, t) = \sum_{k=1}^{\infty} T_k(t) \sin\left(\frac{k\pi x}{h}\right), \quad (23)$$

where,

$$\begin{aligned} T_k(t) &= \frac{2}{h\omega_k} \times \\ &\times \int_0^1 dr \int_0^h \tilde{g}(x, \tau) \sin[\omega_k(t-r)] \times \\ &\times \sin\left(\frac{k\pi \xi}{h}\right) d\xi, \quad \omega_k = \frac{k\pi a}{h}. \end{aligned} \quad (24)$$

$$\begin{aligned} v(x, t) &= \sum_{k=1}^{\infty} T_k(t) \sin\left(\frac{k\pi x}{h}\right) + \\ &+ \sum_{k=1}^{\infty} \left\{ a_k \cos\left[\frac{k\pi a t}{h}\right] + b_k \sin\left[\frac{k\pi a t}{h}\right] \right\} \times \\ &\times \sin\left[\frac{k\pi x}{h}\right]. \end{aligned} \quad (25)$$

The first term in (25) is a layer of concrete mix fluctuations, caused by the presence of gravity and magnitude of the effect of the working body surface lining for

placement of horizontal surfaces with zero initial conditions.

The second term in (25) is a layer of concrete mix fluctuations, caused by the presence of non-zero initial conditions.

Table 2, 3 presents values  $\omega_k, s^{-1}$  for  $k = 1,2,3$  and different values of  $h, m, a, m/s$ .

In the case of resonance ( $\omega = \omega_k$ ) the time during which an increase of the amplitude of the movement in the layer of concrete mix is determined by the approximate relation:

$$t_{incr.} = \frac{2}{\gamma\omega} \tag{26}$$

For typical values of  $\omega$  (see Tab. 1) and  $\gamma(\gamma = 0,1...0,3), t_{incr.}$  is (0.01...0.02) s.

As a result of solving the problem of survey was requested and made screeds  $l = 2$  m,  $l = 3$  m and  $l = 4$  m, are put into production. Specifications of screed  $l = 3$  m and  $l = 4$  m are shown in Tab. 2.

**Table 1.** The numerical values

h, m	a = 20 m/s			a = 40 m/s			a = 60 m/s		
	k			k			k		
	1	2	3	1	2	3	1	2	3
0,1	228,3	125,7	188,5	125,7	251,3	377,0	188,5	377,0	565,5
0,15	218,9	237,8	125,7	237,8	167,6	251,3	125,7	251,3	377,0
0,2	314,2	228,3	242,6	228,4	125,7	188,5	242,6	188,5	282,8

**Table 2.** Specification screeds

Parameter	Performance, m <sup>3</sup> /h		Oscillation frequency rad/s	Static moment, kg×m	Power, kW	Dimensions, l×b×h	Mass, kg	
	l = 2 m	l = 3 m					l = 2 m	l = 3 m
The numerical values	60- 180	90-270	314	0,046; 0,058; 0,072; 0,092	0,6	2(3)×0,4×0,27	52	72,8

For determination of the energy is necessary to make the equation of energy balance, for this work  $A$ , performed by external force  $F(t)$  at time  $T$ , equivalent to the total dissipative energy losses in the system at the same time [10]. These losses consist of: viscous losses in the nodes of the machine; dissipation of energy when hitting the limiter of oscillations; the energy lost to seal the concrete mix for the period of oscillation  $T$ . Based on these assumptions, we can write the expression for work:

$$A = \int_0^T (c_{ve} + c_{eq.post.} + c_{eq.p.}) \dot{x} dt + (1 - R^2) A_k + A_\delta \tag{27}$$

where  $R$  - factor recovery rate when hitting the limiter of oscillations;  $A_k$  - kinetic energy of the form with concrete mix before hitting of the limiter of oscillations;  $A_k = [m_\delta + m'_\delta] \dot{x}^2(\tau_1) / 2$ ;  $c_{ve}$  - equivalent stiffness losses in viscoelastic vibration nodes of machine;  $A_\delta$  - average height  $h$  mix work for the period  $T$ , which lost in the consolidation of this mixture.

Assume designations:

$$\eta_{\mu} = c_{ve} + c_{eq.post.} + c_{eq.p.} \quad (28)$$

Find work  $A_{\delta}$  in accordance with the equations of motion of the mixture and expression for the contact force [10]. Elementary work  $F_{eq.fric.}$  of friction in the mix:

$$dA_{\delta} = F_{eq.fric.} du = \gamma_{\delta} \frac{\partial^2 u(y,t)}{\partial y \cdot \partial t} du \quad (29)$$

where  $\gamma_{\delta}$  - coefficient characterizing energy loss in the mixture,  
 $u(y,t)$  –moving in layers of mix.

Because

$$du = \frac{du}{dy} dy + \frac{du}{dt} dt,$$

then (29) can be written:

$$dA_b = \frac{\gamma_{\delta} \cdot \partial^2 u}{\partial y \cdot \partial t} \cdot \left[ \frac{du}{dy} dy + \frac{du}{dt} dt \right]. \quad (30)$$

The first term that depending brackets (30) describes work in elementary layer of concrete mix, which is connected with its deformation, and the second term – with the movement of a single layer. The average value of losses on the height of the product in one period of the movement (30), we obtain the expression:

$$A_{\delta} = \frac{1}{T} \frac{1}{h} \int_0^h dy \int_0^T dt \left[ \int_0^h \frac{\gamma_{\delta} \partial^2 u}{\partial y \partial t} \frac{du}{dy} dy + \int_0^T \frac{\gamma_{\delta} \partial^2 u(y,t)}{\partial y \partial t} \frac{du}{dt} dt \right]. \quad (31)$$

In consideration of equivalent (average) values of amplitude after simple transformations (31) we have:

$$A_{\delta} = \int_0^T n_{\delta} \dot{x}^2 dt, \quad (32)$$

where:

$$n_{\delta} = 2R_e \left\{ \frac{\gamma_{\delta} e^{-2z}}{\left[1 + e^{-2z}\right]^2} \left[ \frac{1}{2} \left( \frac{z}{i2\pi h} + \frac{1}{h} \right) \times \right. \right. \\ \left. \left. \times \left( e^{2z} - e^{-2z} \right) - \frac{2z^2}{i2\pi h} \right] \right\}, \quad (33)$$

$$z = h(\alpha_1 + i\beta_1)$$

$$\alpha_1 = \frac{\omega_{av.}}{c_{\delta}^4 \sqrt{1 + \gamma_{\delta}^2}} \cos \left[ \frac{1}{2} \arctg(-\gamma) \right];$$

$$\beta_1 = \frac{\omega_{av.}}{c_{\delta}^4 \sqrt{1 + \gamma_{\delta}^2}} \sin \left[ \frac{1}{2} \arctg(-\gamma) \right].$$

The formula (33) is much simpler if you accept some conditions. For example, for  $|z| \gg 1$ :

$$n_{\delta} = \gamma_{\delta} \cdot \frac{|\beta_1|}{2\pi}; \quad (34)$$

for  $|z| \ll 1$ : in general terms  $n_{\delta} = f(h)$ .

Thus the energy balance equation can be folded in a way that limits the possible vibration amplitude will be determined by the upper – viscosity effects, and bottom – the shock dissipation. In the case under consideration, vibration resistant operation will be when  $\omega_{av.} = \omega$ :

$$\frac{1}{2} \cdot \frac{(m_1 + m'_{\delta})}{(m'_{\delta})} \leq q \leq \\ \leq \sqrt{\frac{m_1 \omega(1+R)}{8\pi(n_i + n_{\delta})(1+R)}}; \xi > \frac{1}{2} \quad (35)$$

In the case of abrupt vibrator and mixture  $\xi > 1/2$  is selected from those provisions, leading to shock-vibration mode in the system and then had realized one hit in one period of movement.

When conditions (35) the average of the amplitude of vibration will be determined from the following relationship:

$$\frac{F_0}{2(n_\delta + n_m)\omega} \left\{ 1 - \sqrt{1 - \frac{4q^2(n_\delta + n_m) \cdot c^*}{\omega}} \right\} \leq \leq A_{sr.} \leq \frac{F_0}{2(n_\delta + n_m)\omega} \left\{ 1 + \sqrt{1 - \frac{4q^2(n_\delta + n_m) \cdot c^*}{\omega}} \right\} \quad (36)$$

where  $c^* = 2\pi(1 - R)/[m_1(1 + R)]$ .

Calculations by the formulas (35) in relation machines for seal concrete mix give range for values:  $0,6 \leq q \leq 1,5$  and  $1,4 \leq \xi \leq 2,5$  [7]. Thus for the criteria  $q$ , which determines the balance of power, the value  $q \approx 1,0 \dots 1,5$  corresponds criteria  $\xi$ , which has the value  $\xi = 0,8 \dots 1,3$ . This is the first (Fig. 3) zone of stability, which in terms of selection parameters more suitable in certain accurately mass characteristics. This area is sensitive to changes of mass in the process of movement of the shock-vibration installation. The zone of stability at  $q \approx 0,6 \dots 0,7$ , which corresponds to  $\xi = 2,0 \dots 2,5$ , requires less power loss, but the amplitude spectrum may decrease, which follows from the analysis of the formula (36). Map of stability

(Fig.1), built for a wide range of parameters, confirms the possible existence of several zones (at least three for installation of forming units) of stability.

In Tab.3 are shown numerical values of performance parameters of vibration-shock process to determine their effect at the time of impact  $t_{imp.}$ .

Calculations that are made for resulted parameter values (see Tab.1) show that for the acceleration coefficient  $a_{max} = (4 \dots 5)g$  at coefficient of restoration of speed  $K_v = 0,3 \dots 0,4$  time of impact is equal to  $t_{imp.} = (0,015 \dots 0,01)s$ , that is for the frequency,  $\omega = 157s^{-1}$  ratio  $\frac{\tau}{T} = 0,358 \dots 0,238$

which determines the effect of intense acceleration on the process of compaction. An important characteristic that affects the parameter  $K_t = \tau/T$ , as at the time of contact is coefficient of stiffness.

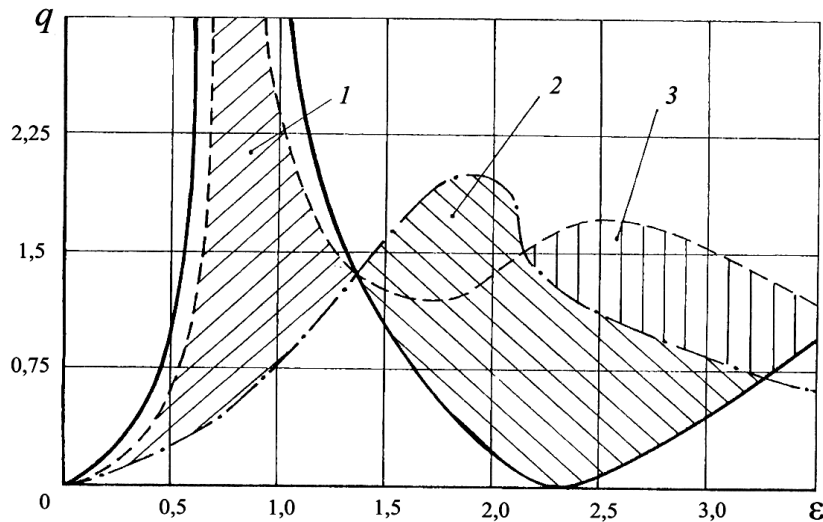

**Fig. 1.** Map stability of motion of the shock vibration systems: 1 – first zone, 2 – second zone, 3 – third zone

**Table 3.** Limits change of parameters of vibration-shock process

Acceleration in the destiny, $a_{max}/g$	Dimensionless coefficient of resistance, $\delta$	Coefficient of speed recovery, $K_v$	Time of blow, $t_{yd} \cdot 10^{-2}$ , s
3...10	0,045...0,3	0,3...0,8	1,5...1,95

### CONCLUSIONS

1. In the case of application of vibration impacts are commonly used to determine the dependence of the calculated viscosity require considerable refinement: necessary to account for vibration, and in some cases the inertial forces of resistance fluctuations.
2. To ensure that the products of good quality (horizontal surface), where the presence of cavities and shells kept to a minimum, you must set the mode vibro-formation concrete mixes, which are inherent limitations to the vibration amplitude.
3. The basic laws of motion of a concrete mixture is compacted surface lining in the process of improvement of concrete horizontal surfaces, methods of mathematical physics, and held valid in terms of mathematics, the procedure for obtaining general solution of equations, allowing full use of the Fourier method.
4. Dependences should be used in the improvement and refinement of engineering calculations such systems in order to optimize them and to improve the quality furnished horizontal surfaces.
5. Formulated energy balance, realizing the impact-vibration mode mixed discrete-continuous system of movement.
6. Getting analytical dependences for definition of rational parameters of workflow and new different from main resonance, movement stable zones of contribution of higher harmonics.

### REFERENCES

1. **Sviderskiy A.T., 2013.** The study of the dynamics of vibrating machines based on the stress-strain state of elastic-plastic medium. Vinnytsya. Vibrations in engineering and technology. №3 (71), 41-45.
2. **Dedov O.P., 2006.** Mathematical model and determine the parameters of vibration ram for soil compaction. Girniči, budivelni, dorozni ta meliorativni masini [Mining, constructional, road and melioration machines], Nr 66, 41-46.
3. **Zapryvoda A.V., Ruchynskiy M.M., 2013.** Study of the basic characteristics of the process of forming horizontal surfaces working body vibration. Kyiv. Theory and practice of building. Nr12, 44-47.
4. **Runova R.F., Gots V.I., Nazarenko I.I. and others., 2008.** Materials of construction of a new generation and technologies introduction. Kyiv. UVPK, Eks 05, 360.
5. **Rudenko I.F., 1972.** Formation of products of surface vibrator. Moskow, Stroyizdat, 104.
6. **Savinov O.A., Lavrinovich E.V., 1986.** Vibrating machinery seals molding concrete mixtures. Leningrad. Stroyizdat, 280.
7. **Harnets V.M., 1991.** Advanced units and complexes. Kyiv, Builder, 144.
8. **Chubuk Y.F., Nazarenko I.I., Harnets V.N., 1985.** Vibrating machines for compacting concrete mixtures. Kyiv, Higher school, Head publishing house, 165.
9. **Goldshhteyn B.G., Petrun'kin L.P., 1966.** Vibrators for compacting concrete. Moskow, Engineer, 172.
10. **Nazarenko I.I., Ruchynskyy M.M., 2013.** Energy ratio in shock vibration machines for seal concrete mixes. Vinnytsya, Vibrations in engineering and technology, №3 (71), 67-71.
11. **Nazarenko I.I., 2007.** Vibrating machines and processes of the construction industry. Kyiv, KNUCA, 230.

12. **Nazarenko I.I., 2010.** Applied Problems vibration systems theory (2nd Edition), Kyiv, Publishing House Word. 440.
13. **Nazarenko I.I., Ruchynskyy M.M., 2002.** Physical principles of mechanics of building materials, Lviv, Poster, 128.
14. **Sivko V.I., 1988.** Fundamentals of mechanics of vibrating concrete, Kyiv. Higher school, 168.
15. **Osmakov S.A., Braude F.G., 1972.** Vibro-shock forming machines, Moskow, Stroyizdat, 152.
16. **Osmakov S.A., 1964.** Motion Study of vibrating platform with a form of freely resting on the elastic pad. Tr. VNIIGS, Moskow, Leningrad. Producing 17, with 105-111.
17. **Goncharevich I.F., Sergeev P.A., 1963.** Vibrating machine construction, Moskow, Engineering, 311.
18. **Mariusz Saniak., 2014.** Energy Balance of a Prosument Microinverter On-Grid Photovoltaic System. Teka Komisji Motoryzacji i Energetyki Rolnictwa Vol. XIV-3, Poland, 99-103.
19. **Krzysztof Necka., 2013.** Selection of decisive variables for the construction of typical end user power demand profiles. Teka Komisji Motoryzacji i Energetyki Rolnictwa, Vol.XIII-2, Poland, 67-72.
20. **Anna Nikolaenko, Alsayyad Taha Hussein., 2014.** Modelling of vibrating machine-tool with improved construction. Teka Komisji Motoryzacji i Energetyki Rolnictwa, Vol.XIV-1, Poland, 174-181.

ОПРЕДЕЛЕНИЕ ОСНОВНЫХ ПАРАМЕТРОВ  
ВИБРАЦИОННЫХ УСТАНОВОК ДЛЯ  
УПЛОТНЕНИЯ ГОРИЗОНТАЛЬНЫХ  
ПОВЕРХНОСТЕЙ

**Аннотация.** Рассмотрена и определена закономерность движения виброустановки для формирования горизонтальных поверхностей на основе учёта волновых явлений и напряжения сдвига. Приведены числовые значения параметров виброрейки и реологических характеристик уплотняемой бетонной смеси. На основании рассмотрения энергетического баланса энергии определяются ограничения на параметры движения. Предложены аналитические зависимости для расчёта основных параметров эффективного виброударного режима и приведена карта устойчивости движения исследуемой системы.

**Ключевые слова:** бетонная смесь, резонанс, уплотнение, вибрация.



## The assessment of heavy metal accumulation by myxomycetes

Tetiana Kryvomaz

Kyiv national university of construction and architecture  
Povitroflotskyi prosp., 31, Kyiv, Ukraine, 03680, e-mail: ecol@i.ua

**Summary.** The assessment of heavy metal accumulation by myxomycetes (slime moulds) has been made. The importance of these organisms for environmental safety monitoring was specified. Ecological and physiological mechanisms of ability of myxomycetes to concentrate metals and other elements from their substrates were analyzed. For five common myxomycetes species with relatively big fruiting body were compared chemical elements concentrations. *Fu-ligo septica* (L.) Wigg. was proposed as perspective bioindicator for the detection of Zn on the grounds of the ability to accumulate this metal and by reason of this species have widespread distribution in terrestrial ecosystems. Prospects of using slime molds as objects for bioremediation of contaminated soils were considered.

**Key words:** environmental safety, risk assessment, heavy metal, myxomycetes.

### INTRODUCTION

An important place in environmental safety has problem of heavy metals accumulation in nature. Heavy metals in soils and forest litter are derived from anthropogenic pollutant and natural soil weathering sources. [14]. There are 4 level of danger for heavy metals: high (As, Cd, Hg, Se, Pb, Zn), tempered (Co, Ni, Mo, Cu, Cr, Sb), low (Ba, V, W, Mn, Sr) and unknown (Ge, Sn, Ce, La, Bi, Y, Rb, Cs, and others) [9]. According to modern concepts, living organism forms and controls in the biosphere flows of matter and energy, ensuring consistency of environmental parameters [6]. The main re-

actions of a living organism associated with the toxic effects of excess elements are: changes in cell membrane permeability (Au, Ag, Cd, Cu, F, Hg, I, Pb); competition for vital metabolites (As, Sb, Te, W, F); a high affinity with the phosphate groups and the active centers of ATP and ADP (Al, Zr, and probably all of the heavy metals); substitution of vital ions (Cr, Li, Pb, Sr); capture molecules positions held important functional groups [13].

The proportionality between content of element in soils and their removal to living organisms is direct not for all heavy metal. It is the case for Ni and Cr, but for Zn, Mn and Cd was shown limited transition metals in phytocenosis biomass. For example, increases Zn concentration in soils in more than 20 times, will give its removal in 1,5 times only. The restriction of transition metals in the aboveground part was observed for Fe, Cr, Pb. For fungi the highest transition index is for Hg, Cd, Cu, Zn and Se [13].

Living organisms involved in all of the elementary soil and biological processes that directly or indirectly affect the mobility of trace elements. In different trophic levels are actively involved in the stabilization medium, acting both as original geochemical barriers and as storage of chemical elements in trophic chains ecosystems. The deformation of the biogeochemical cycles with chemical environmental pollution can destabilize many processes in ecosystems [1].

Myxomycetes have been documented to occur virtually all types of terrestrial ecosystems, and extend geographically from the Polar Regions to the tropics, wherever detritus is present. Even 1cm<sup>3</sup> of soil can contain to 20,000 individual myxomycetes cells [2]. One of ecological role of these organisms is utilizing organic matter from various microhabitats. This suggests that myxomycetes are important in nutrient cycling as members of the detritus food chain [11]. Plasmodia of slime molds (myxomycetes) obtain nutrients by ingesting bacteria, protists, fungal hyphae and spores, and particles of organic matter from their immediate environment [15]. Because myxomycetes are ubiquitous in terrestrial ecosystems and accumulate material only from their immediate environment, they can be using in biomonitoring heavy metal contamination at different locations in environmental safety [8]. Some myxomycetes appear to be tolerant of high levels of heavy metals and apparently accumulate them vigorously [14].

#### PURPOSE OF WORK

The objective of this study is to make assessment of heavy metal accumulation by myxomycetes. According with this purpose was planed to 1) analyze data about heavy metal accumulation by myxomycetes; 2) examine ecological and physiological mechanisms of ability of myxomycetes to concentrate metals and other elements from their substrates; 3) determine potential of these organisms for environmental safety monitoring for bioindications and bioremediation of heavy metal.

#### MATERIAL AND METHODS

Material for this study is result of myxomycetes research for more than 20 years in their native habitats in Ukraine [5], and also in forest, forest-steppe, desert, mounting, tropical vegetation over world. Samples of myxomycetes were collected from protected areas and from territory with anthropogenic

impact for study patterns of myxomycetes distribution. A series of monitoring plots were established in an affected area and adjacent unaffected sites for compare myxomycetes developed under natural conditions in the field and on polluted urban areas.

The analysis of heavy metal concentrations have been made with utilizing of literature data [8, 10, 12, 16, 18]. In these studies fruiting bodies of slime molds were analyzed by atomic absorption (Pb) or inductively coupled plasma emission spectrometry (Fe, Mn, Cu, Zn, Al) to determine heavy metal concentration. Individual mature fruiting bodies were prepared for light microscopy (LM). Additional specimens were prepared for electron microscopy (TEM) and X-ray microanalysis (EDX) to determine location or accumulation of heavy metals in various regions of the fruiting body. [3, 8].

For assessment of heavy metals accumulation in myxomycetes fruiting body and plasmodium the transition index using:

$$K_t = \frac{C_m}{C_s}, \quad (1)$$

where:  $K_t$  - transition index of heavy metals;  $C_s$  - heavy metals concentration in soil;  $C_m$  - heavy metals concentration in myxomycetes.

It is suggested to use the total risk summary, while the influence of several factors:

$$i_{ir}^{sum} = \sum_{i=1}^n i_{ir_i}, \quad (2)$$

where:  $n$  – number of risk factors,  $i_{ir_i}$  – risk performance for the  $i$ -th factor [17].

The analytical methods used demonstrate bioaccumulation of heavy metals in myxomycetes.

#### RESULT OF RESEARCH

Preliminary compare of myxomycetes assemblage on protected nature territory and on contaminated areas didn't reveal reduction of species abundance, but it find of change of

species composition, which can be caused by pollution. Both the biodiversity and relative abundance of the myxomycetes determined in field show that distribution of these organisms depends on the availability of suitable substrates and climate. Also there are some correlations between the densities of myxomycetes and various environmental parameters. Thus feasibility of utilizing these organisms to assess the accumulation of heavy metals in the environment has been reported in several researches.

For study of environmental pollution effect to myxomycetes in south-west Finland the following metals were selected: Al and Fe (major soil constituents), Zn and copper (essential plant nutrients), and mercury and cadmium (notoriously toxic metals) [12]. Then fifteen collections from Australia, Canada, New Mexico and Switzerland were analyzed for about 60 chemical elements. Some myxomycetes species demonstrate tolerate to incredibly high levels of heavy metal accumulation. The results of this research were processed and present on graphs (Fig. 1-5) for five myxomycetes species: *Fuligo septica* (L.) Wigg., *Reticularia splendens* Morgan, *R. lycoperdon* Bull., *Tubifera ferruginosa* (Batsch) J.F. Gmel. and *Lycogala epidendrum* (L.) Fries. This species have relatively big fruiting body and three of them (*F. septica*, *L. epidendrum*, *T. ferruginosa*) are in many habitats around the world.

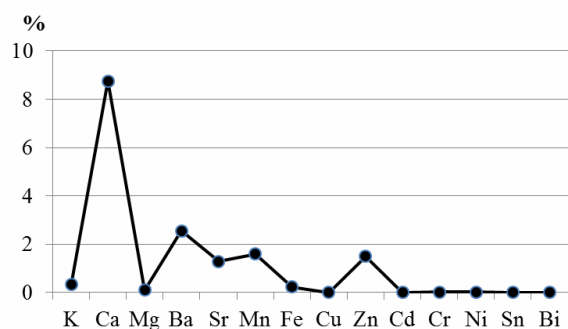

**Fig. 1.** Concentrations of metals in *Fuligo septica*: total contain on the average 16,39% on dry matter of fruiting body

*F. septica* (Physarales) produces the largest plasmodium and aethalium of any slime mold (from 2 to 20 cm in diameter and some-

times even more). High level Ca (4800...1120 mg/kg based on dry matter) is typical for species from order Physarales (Fig. 1). Calcium is essential element for building thick lime cortex and other structures of fruiting body. This is why mobile vegetative stage plasmodium contained much less Ca, than generative stage of its life cycle. The presence of high concentrations of the mildly toxic metals strontium (237–2190) and Ba (294–15190 mg/kg based on dry matter) is surprising. These metals are belonging to the same chemical group and could, therefore, be simultaneously absorbed with the calcium from the soil. The element radium also chemically rather close and with gamma spectrometry found indeed evidence of a low, but significant concentration of Ra 226 (670 Bq/kg).

Even more amazing is the presence of a staggering amount of Mn (116–4570 mg/kg based on dry matter) compared with a relatively low Fe (232–478 mg/kg based on dry matter) content. These metals are chemically close, but in most organisms, e.g. fungi, iron predominates over.

As it was shown in several study, *F. septica* has an enormous affinity for zinc Zn (395–3600 mg/kg based on dry matter) [16]. It contains on the average 240 times more than the *Vaccinium* (10-160 mg/kg in blueberry leaves). The high amount of zinc in *F. septica* is rather intriguing, since it is much more than ever encountered in macromycetes which contain on the average 100 mg/kg on dry matter [12]. In other study the biomass collected ranged from 305 to 968 mg, whereas Zn concentrations in plasmodia of *F. septica* ranged from 8400 to 23000 mg/kg (-1) dry wt. It is remarkably, that forest litter on which this species was found had Zn concentrations of only 25 to 130 mg kg (-1) dry wt. [18]. A higher concentration of Zn is in hypothallus regions of *F. septica* near the base of the fruiting structure than in other areas of the fruiting body. These metals appeared to be “complexed” and thus may not affect myxomycete growth or reproduction. Tolerance to high levels of heavy metals may be related to the ability to sequester them in

regions where reproduction is unaffected [8]. They suggested that the metal probably affords protection from some more dangerous factor by acting as an enzyme activator in detoxification systems. This hyperaccumulation ability of Zn in *F. septica* seems to be unique to this species. The mechanism of this metal resistance is now understood: *F. septica* produces a yellow pigment called fuligorubin A, which has been shown to chelate metals and convert them to inactive forms [7].

In addition, in lesser but still significant amounts, Ba, Cd, Fe, Mg, and Sr were found in *F. septica* in amounts much greater than in macromycetes and micromycetes. The iron and cadmium content are also higher than the amounts measured in the substrate, but the concentration rates are much smaller [16].

Fruiting bodies of *T. ferruginosa* crowded together and compressed, forming raspberry-like forms. Individual fruit bodies are less than 0,5 mm wide and are up to 3-5 mm high, but compressed clusters can be up to 15 cm or more in length.

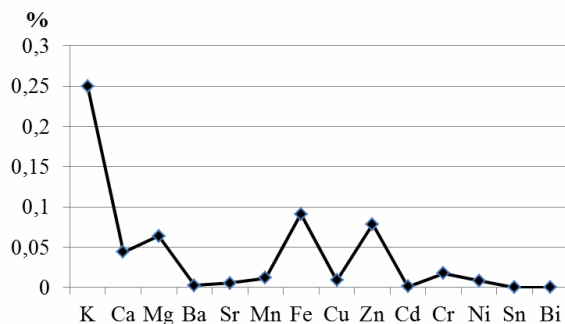
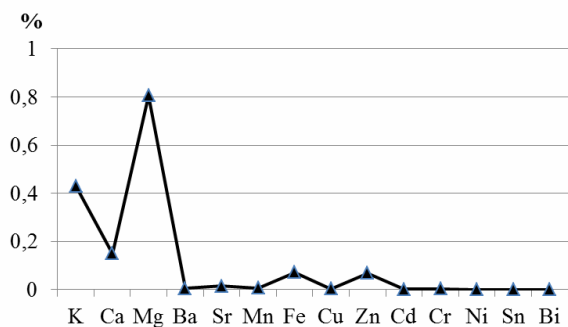

**Fig. 2.** Concentrations of metals in *Tubifera ferruginosa*: total contain on the average 0,58% on dry matter of fruiting body

*Tubifera ferruginosa* (Liceales) seems to be poor in metals (Fig. 2). In fruiting body of this species K contains in the highest concentration (210–290 mg/kg based on dry matter) in compare with other metal, but it is less, then in *F. septica* (220–390 mg/kg based on dry matter) and *R. lycoperdon* (380–480 mg/kg based on dry matter). This species apparently only concentrates heavy metals iron (67–115), zinc (74–83) and magnesium (61–68 mg/kg based on dry matter), but the levels are far less spectacular. The calcium concen-

trations of *Tubifera* (28–61 mg/kg based on dry matter), are less than in *F. septica*, but significantly higher than those measured in macromycetes. In fungi the non-metal phosphorus plays a key role in the intracellular transport of many metals (as soluble complex phosphates), and its level is indeed positively correlated with the heavy metal concentrations present. These observations do not seem to apply to slime moulds, since the phosphorus content of *Tubifera ferruginosa* [16].

Two species genus *Reticularia* (Liceales) are not so common as *F. septica*, *T. ferruginosa* and *L. epidendrum*, but they especially analyzed for showing distinguish in metal composition for related slime molds (Fig. 3, 4). Both have rather large pulvinate fruiting bodies (from 1 to 8 cm in diameter), but *R. splendens* usually forming a white hypothallus ring about the base of the aethalium.



**Fig. 3.** Concentrations of metals in *Reticularia splendens* total contain on the average 1,56% on dry matter of fruiting body.

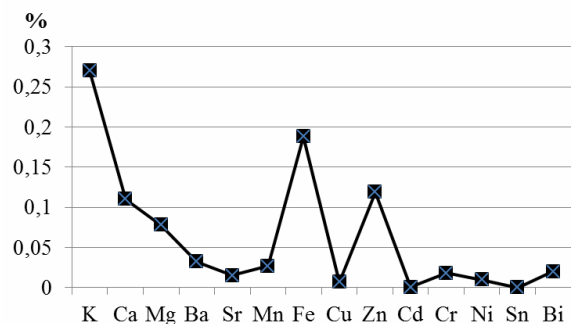

**Fig. 4.** Concentrations of metals in *Reticularia lycoperdon*: total contain on the average 0,89% on dry matter of fruiting body

Most significant differences between species of same genus is high concentration Mg (805 mg/kg based on dry matter) in fruiting body of *R. splendens*, while *R. lycoperdon* contains only 78 mg/kg (based on dry matter) of this element. In contrast to other species of this genus, *R. splendens* demonstrate a bit lower level of K (380-480) and Ca (150 mg/kg based on dry matter); in case of *R. lycoperdon*, these data take the meaning 270 and 110 mg/kg (based on dry matter) respectively. In turn *R. lycoperdon* has high content of Fe (188), Zn (119), Ba (32) and Mn (27 mg/kg based on dry matter), while as in *R. splendens* these elements have a concentration 65-78, 69, 5-6 and 5-7 mg/kg (based on dry matter) in accordance with the order of citation elements [16].

*L. epidendrum* is most well known and most common species of slime mold. It has carmine-pink plasmodium, which developing into a grey-brown crowded aethalium 3-10 mm in diameter.

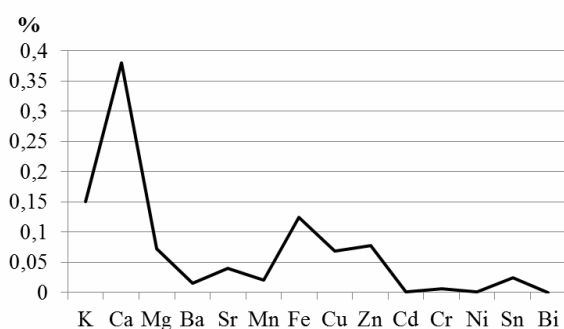

**Fig. 5.** Concentrations of metals in *Lycogala epidendrum*: total contain on the average 0,98% on dry matter of fruiting body

*L. epidendrum* (Liceales) seems to bioaccumulate copper (52–84 mg/kg based on dry matter), whereas the four other slime moulds appear to exclude this metal (Fig. 5). In most *L. epidendrum* specimens was observed not less than 20 mg/kg tin (19–30 mg/kg based on dry matter), a metal that usually occurs only in traces (<1 mg/kg) in plants, animals and fungi. It is noteworthy that no accumulation of elements from the same group such as arsenic and antimony could be found [16].

It is worth noting that in the five slime molds the essential element Mn is present at the same concentrations as those generally observed in macromycetes. The magnesium content of mushrooms is subject to little variation. The metal K, the principal cation in green plants and mushrooms is very low in slime moulds. The concentrations even lower than those of the Polyporaceae which contain generally about 1% of potassium on dry matter [16].

Other slime mold species (*Symphytocarpus flaccidus* (Lister) Ing & Nann.-Bremek., *Amaurochaete atra* (Alb. & Schwein.) Rostaf., *Ceratiomyxa fruticulosa* (O.F. Müll.) T. Macbr., *Stemonitis* sp.) apparently only concentrates zinc, cadmium and, perhaps copper, but the levels are far less spectacular, then present data [12].

In some stalked myxomycetes species of genus *Hemitrichia*, *Physarum*, *Trichia* heavy metals were detected only in the stalk region. The analytical methods suggest that metal precipitation in the stalk region may provide tolerance to high metal levels. By EDX, metals (Fe, Cr, Mn, Si, Al) were detected as crystalline precipitates in the stalks of fruiting bodies. Viewed by TEM, clusters of bacteria were observed in stalk and hypothallus regions. The bacteria and individual spores in sporangia contained polyphosphate bodies (including P, Ca, K) in their cell cytoplasm. EDX analysis showed the electron-dense precipitate in *Physarum* comprises Fe, Si, Al, Mg, Cl, Cr, and Mn. By contrast, regions of the *Hemitrichia* stalk with deteriorated plasmodial material contained only P and Cl. The most common metals detected in stalk sediment were Fe, Al, and Cr. Precipitates of Al, Si, K, and Cl on outer stalk or peridium walls were seen frequently in all species examined and possibly represent minute soil particles. In all analyzed stalked species, the polyP bodies seen in spores within sporangia and in bacteria from stalk regions contained P, Ca, and occasionally K [8].

For determine the accumulation of heavy metal, myxomycetes were assessed from forest patches on volcanic and ultramafic soils of Philippines. Collected substrates, fruiting

bodies, and plasmodia of selected myxomycetes tested for heavy metal were all positive for Cr and Mn. Interestingly, Cr and Mn contents of tested myxomycetes were equal or higher than that of its leaf substrate. The bio-absorption of Cr and Mn by myxomycetes has been assessed, and the heavy metal content of substrates and fruiting bodies determined for selected species [10].

## DISCUSSION

For environmental safety would generate a body of novel information relating to the ecological effects of targeted analytes on terrestrial community of living organism dynamics. The concentration of metals depends not only on the biological characteristics of the species and the phases of their development, but also on the environmental situation in the area of their occurring. The resistance of myxomycetes to overage heavy metals may have different mechanisms. It is possible that myxomycetes have tolerance to these chemical elements or make some effective barrier for protection physiological functions. At present, little is known about the chemical forms in which the metals occur in the myxomycetes. Transport of heavy metals depends from pH of environmental. It is considered that true tolerance based on such complex mechanisms of metabolic protection as: change of metabolism; differences in membrane structure and function; selective ions absorption; removal of ions from metabolic processes by deposition or a fixed insoluble forms in different organs and organelles, etc. [13]

The concentration of heavy metals in the forest litter is higher than in living plants [13]. On the other hand, the concentration of some heavy metals in fruiting bodies studied myxomycetes is higher than in their substrates and soil (Fig. 6).

The myxomycetes merit recognition in the scientific community as organisms of special significance that can answer basic biological questions. These organisms apparently play a major role in maintaining the ecological bal-

ance that exists between bacteria and other soil organisms. The myxomycetes seem especially well suited to serve as biological indicators in environmental safety for assessing the fundamental differences that exist for the soil microbial system among selected study sites [6].

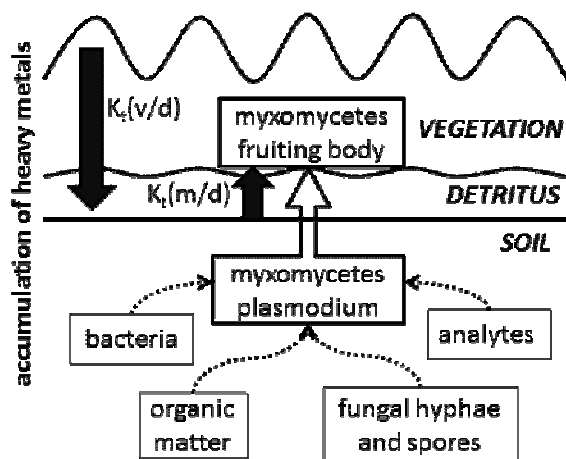

**Fig. 6.** The scheme of heavy metals accumulation by myxomycetes: heavy metals concentration ( $K_t$  - transition index of heavy metals) increases in the direction from substrates to myxomycetes, and it decline from the forest floor to the trees

In perspective environmental ground pollution may be remediated by myxomycete fruiting bodies and plasmodia. The results for *F. septica* proved to be most remarkable. This species hyper-accumulate and concentrate highly toxic levels of Zn several thousand fold greater than site vegetation and lesser significant amounts of Ba, Cd, Fe, Mg, and Sr. The massive, cushion-shaped aethalium of this species has a large yellow plasmodium that may serve as an experimental model to study the uptake and concentration of heavy metals. The biochemical detoxification mechanism of highly toxic levels of zinc in *F. septica* and the cloning of the genes involved could be used in plants with greater biomass for bioremediation of polluted soils [4]. Also *F. septica* may be useful as an indicator of pollution, and further examination of this species (to determine the location of Pb in the fruiting body) should be pursued.

Moreover, the considerable variation in metal concentrations between the two *Fuligo* collections from low elevation indicates that additional collections of all myxomycetes species are needed to determine whether a relationship exists between metal concentration and site elevation [8]. Tree canopy research has shown that aerial pollution results in the decrease of myxomycete species richness at higher elevations. When more environmental parameters are better known myxomycetes may one day serve as the basis for evaluating the impact of pollutants on living trees [4].

Ultimately, a better understanding of this entire system could lead to the development of methodologies utilizing myxomycetes to assess remediation efforts at spill sites. In addition, these methods could be used to monitor the conditions associated with various storage operations such as the leeching of selected analytes [11].

### CONCLUSIONS

Living organisms involved in all of the elementary soil and biological processes that directly or indirectly affect the mobility of trace elements. The myxomycetes are organisms of special significance that can answer basic biological questions. Myxomycetes seem especially well suited to serve as biological indicators in environmental safety for assessing the fundamental differences that exist for the soil ecosystem.

1. The assessment of heavy metal accumulation by myxomycetes shows the importance of these organisms for environmental safety monitoring.

2. Myxomycetes have undiscovered potential for bioindications and bioremediation of heavy metal and environmental management.

3. The scheme of heavy metals accumulation by myxomycetes was made to demonstrate that heavy metals concentration increases in the direction from substrates to myxomycetes, and it declines from the forest floor to the trees.

4. The concentration of metals depends not only on the biological characteristics of the species and the phases of their development, but also on the environmental situation in the area of their occurring, in this connection the resistance of myxomycetes to overage heavy metals may have different mechanisms.

5. *Fuligo septica* (L.) Wigg. was proposed as perspective bioindicator for the detection of Zn on the grounds of the ability to accumulate this metal and by reason of this species have widespread distribution in terrestrial ecosystems.

### REFERENCES

1. **Adl M. S., Gupta V. V. S. R., 2006.** Protists in soil ecology and forest nutrient cycling. Canadian Journal of Forest Research. 36, 1805-1817.
2. **Feest, A., 1987.** The quantitative ecology of soil mycetoza. Progress in Protistology, 2, 331-361.
3. **Gromenko V., Krivonosov S., Snizhko A., 2012.** X-raystructural research of products of cavitation erosion of metals. Teka Komisji Motoryzacji i Energetyki Rolnictwa, 12(3), 41-4.
4. **Keller H.W., Everhart S.E., 2010.** Importance of Myxomycetes in Biological Research and Teaching. Fungi, 3(1), 13-27.
5. **Krivomaz T.I., Dudka I.O., 2011.** Myxomycetes of Ukrainian forests. Proc. 7<sup>th</sup> International Congress on Systematics and Ecology of Myxomycetes, Recife, Brazil, 87.
6. **Landolt J. C., Stephenson S. L., 1995.** Soil bacteria and Fungi. Effects of Diflubenzuron non-target organisms in broadleaf forested watersheds in the northeast. USDA Forest Service, 94-105
7. **Latowski D, Lesiak A, Jarosz-Krzeminska E, Strzalka K., 2008.** *Fuligo septica*, as a new model organism in studies on interaction between metal ions and living cells. Metal Ions in Biology and Medicine and Medicine, 10, 204-209.
8. **McQuattie C.J., Stephenson S.L., 2000.** Use of analytical methods to determine heavy metal concentration or location in fruiting structures of slime molds (Myxomycetes). Proceedings of 11<sup>th</sup> Annual International Con-

- ference on Heavy Metals in the Environment. USA, Michigan, 1189.
9. **Ramazanov S., 2012.** Innovative management models of viable and stable development of technogenic region in crisis. *Teka Komisji Motoryzacji i Energetyki Rolnictwa*, 12(4), 240-247.
  10. **Rea M.A.D., Dagamac N.H.A., Huyop F.Z., Wahab R.A.B., Dela Cruz T.E.E., 2014.** Myxomycetes in forest patches on ultramafic and volcanic soils: assessment of species diversity and heavy metal biosorption. Abstracts of 8<sup>th</sup> International congress on the Systematics and Ecology of Myxomycetes, China, Changchun, 27.
  11. **Rollins A.W., Landolt J.C., Stephenson S.L., 2010.** Myxomycetes and Dictyostelids-vas Biological Indicators. Abstracts of TVA Kingston Fly Ash Release Environmental Research Symposium. USA: ORAU, 25.
  12. **Setala A., Nuorteva P., 1989.** High metal contents found in *Fuligo septica* L. Wiggers and some other slime molds (Myxomycetes). *Karstenia*, 29(1), 37-44.
  13. **Sibirkina A.R., 2013.** Biogeochemical assessment of heavy metals in the leaves of shrubs Irtysh pine forest Semipalatinsk. Actual problems of the humanities and the natural sciences, № 11 (58), Part I, 74-77. (in Russian).
  14. **Stephenson S. L., Mc Quattie C. J., 2000.** Assessing the potential use of myxomycetes as biomonitors of heavy metals in the environment. *Proceedings of the West Virginia Academy of Science*, 72, 32-33.
  15. **Stephenson S.L., Fiore-Donno A.M., Schnittler M., 2011.** Myxomycetes in soil. *Soil Biology and Biochemistry*, Vol. 43, 2237-2242.
  16. **Stijve, T., Andrey D., 1999.** Accumulation of various metals by *Fuligo septica* (L) Wiggers and by some other slime molds (myxomycetes). *Australasian Mycologist*, 18(2), 23-26.
  17. **Vyshnevskyy D., Kasyanov N., Medianyky V., 2013.** The ways of improving performance of industrial risk and working conditions. *Teka Komisji Motoryzacji i Energetyki Rolnictwa*, 13(4), 280-287.
  18. **Zhulidov, D.A., Robarts R.D., Zhulidov A.V., Zhulidova O.V., Markelov D.A., Rusanov V.A., Headley J.V., 2002.** Zinc Accumulation by the Slime Mold *Fuligo septica* (L.) Wiggers in the Former Soviet Union and North Korea. *Journal of Environmental Quality*, Vol. 31, 1038-1042.

#### ОЦЕНКА НАКОПЛЕНИЯ МИКСОМИЦЕТАМИ ТЯЖЕЛЫХ МЕТАЛЛОВ

**Аннотация.** Осуществлена оценка накопления тяжелых металлов миксомицетами (слизевиками). Определена важность этих организмов для мониторинга в сфере экологической безопасности. Проанализированы экологические и физиологические механизмы поглощения миксомицетами металлов и других элементов из субстратов. Для пяти распространенных видов миксомицетов с относительно крупными плодовыми телами проведено сравнение концентрации химических элементов. *Fuligo septica* (L.) Wigg. предложен в качестве биоиндикатора Zn на основании способности накапливать этот металл и по причине широкого распространения этого вида в наземных экосистемах. Предполагается, что миксомицеты могут стать перспективными объектами для ремедиации загрязненных почв.

**Ключевые слова:** экологическая безопасность, оценка рисков, тяжелые металлы, миксомицеты.



## Theoretical studies and calculations of wastewater treatment in trickling biofilters

*Olga Kolpakova*

Kyiv National University of Construction and Architecture  
Povitroflotskyy prosp., 31, Kyiv, Ukraine, 03680, e-mail: kolpakova.o@ukr.net

**Summary.** On the basis of the analysis of existing models and methods of calculation, proposed a general mathematical model of the process of removal of organic contaminants in an aerobic biological wastewater treatment in trickling biofilters with sufficient support bio-oxidation by oxygen. Results of comparison of theoretical calculations with experimental data obtained by different authors in trickling biofilters with different loading are presented. As the results, the theoretical calculations are in general well correlated with the experimental data.

**Key words:** biofilter, waste water, biological film, model, treatment

### INTRODUCTION

An important aspect of environmental problems is to develop a reliable, efficient and economic facilities for treatment of domestic wastewater. In accordance with regulatory requirements it is necessary to conduct a more advanced biological wastewater treatment. Recently becoming more common in practice the biological reactors of different designs, due to the formation of high concentration of microorganisms in the form of attached biofilm on the material loading of the bioreactor, which is effective in removing organic and other contaminants [1, 2, 3, 4, 5].

Biological wastewater treatment in structures with attached biomass in the form of

biofilms has some significant advantages and is widely used in practice and the research of biofilm wastewater treatment processes was developed quite extensively. Unlike flooded filters, in trickling biofilters effluent liquid flows down as a layer over the surface of the feed material that can be run in the form of plates made of polymeric materials or of particles of different rocks [1, 2, 6, 7]. In addition, the air enters the natural way at the top or bottom of the filter with flat flow.

Existing researches on the basis of which was developed and proposed the methods of calculation have been mostly empirical in nature and were developed using simplified approaches (models) and simple theoretical approaches (models). So as a result of the analysis of existing models and methods of calculation of treatment parameters of trickling filters [3], and taking into account also the shortcomings of existing research in [8] the most comprehensive and advanced three-phase mathematical model consists of hydrodynamic block and dynamics block of organic contaminants and air (oxygen) in trickling filters was formulated and proposed. The general scheme of this model is presented in [8, 9]. The mathematical model is described by a system of interrelated equations the solution of which determines the changes in the concentration of contaminants and oxygen in layers and in a trickling filter as a whole. The

analysis of the mathematical model showed that for use in practical calculations, the general model can be simplified, namely considering the flow of contaminants in the biofilm and their removal at a constant conditions. This takes into account that the aerobic treatment process in sufficient quantity provided with oxygen, that is not limited by oxygen, as well as a number of other conditions, which are generally valid and do not introduce significant errors in the calculations [1, 4, 5].

On the basis of implementing the model the engineering methods of calculation of technological and design parameters of treatment trickling filters were proposed [10, 11]. Dependences for determining the variation of contaminant concentration on the thickness of the biofilm and the height of the biofilter under different possible speeds (kinetic) reactions remove organic contaminants are proposed too. The criteria and recommendations to determine the feasibility and optimal thickness of the active biofilms, within which there is an almost complete purification from entering contaminants take place are presented. In [11] to perform the calculations the necessary recommendations on the choice of parameters and coefficients that appear in equations and dependencies are given. The overall biofilm is a heterogeneous structure and the study of the processes occurring in the biofilm devoted a lot of work [4, 5, 12, 13, 14]. So an important parameter in the calculation is determining the calculated thickness of the biofilm, which in this case is an active thickness, consisting of heterotrophic microorganisms, and the formation of its basic parameters largely depends on the load and hydraulic conditions in the biofilter with attached biocenosis. In works [1, 11] on the basis of the implementation of the general equations for determining the formation of the thickness of the biofilm are given specific dependencies to determine its active part taking into account the processes increasing the biofilm thickness, the disintegration of the biofilm and the speed of detachment from its surface. Moreover, we note that in biofilters with attached bioceno-

sis thickness of the biofilm filter will decrease due to the decrease in the concentration of contaminants that are extracted, and with the increase in the specific surface of the material load. The proposed models and methods in general allow us to consider this fact.

A comparative analysis of theoretical calculations with experimental data, which indicates that the proposed model and developed on the this basis the methods of computation for adopted the averaged constant values of thickness of the biofilm  $\delta$  sufficiently reliable and adequately describe and show the processes in these cases [1, 4, 13, 14, 15].

### JUSTIFICATION OF THE MODEL AND METHOD OF CALCULATION

In this article we discussed the basic positions and the results of theoretical studies of aerobic biological wastewater treatment of organic contaminants in trickling biofilters. So, to determine changes in the concentration of organic contaminants (OC)  $L$  within the biofilm thickness  $\delta$  (Fig. 1) it is necessary to obtain the solution of the following equation:

$$D_L \frac{\partial^2 L}{\partial x^2} - R_L = 0, \quad (1)$$

which is performed under the following boundary conditions:

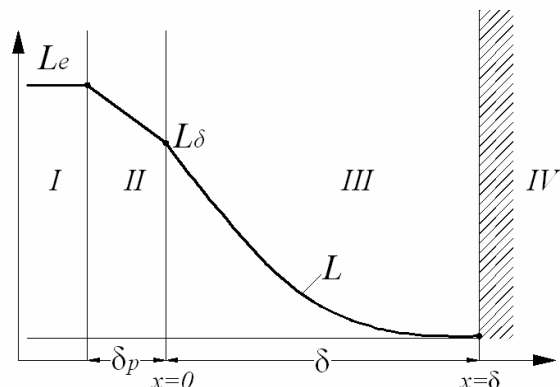

**Fig. 1.** Concentration profiles  $L$  in the biofilm and the liquid film: *I* – fluid flow, *II* – liquid film, *III* – biofilm, *IV* – element load

$$N = -D_L \frac{\partial L}{\partial x} = K_L (L_e - L|_{x=0}) \quad \text{when } x = 0$$

$$\frac{\partial L}{\partial x} = 0 \quad \text{when } x = \delta. \quad (2)$$

It is known [1, 8] that if the process of waste recovery is not limited by the oxygen that is provided by the oxygen in sufficient quantity and the reaction rate in the absence inhibitory effect is expressed by the known equation of Monod:

$$R_L = \frac{\rho_m L}{K_m + L}, \quad \rho_m = \frac{\mu_m X}{Y}. \quad (3)$$

Considering that at comparing low concentrations of contaminants often can be taken  $K_m \gg L$ , and at significant concentrations  $K_m \ll L$  and in these cases the reaction kinetics can be respectively the first and zero order terms, namely:

$$R_{L1} = kL, \quad k = \frac{\rho_m}{K_m}; \quad (4)$$

$$R_{L0} = w_L, \quad w_L = \frac{\mu_m}{Y} X, \quad (5)$$

In the above equations and dependencies the following notation of some of the parameters and coefficients are given:

$L, L_e, L_0$  – the concentration of organic contaminants in the biofilm in the filter and in the input liquid respectively, BOD(g/m<sup>3</sup>), COD(g/m<sup>3</sup>),

$\delta, \delta_p$  – the calculated thickness active (aerobic) biofilm and liquid film (boundary layer) respectively,  $m$ ,

$D$  – the coefficient of molecular diffusion in the biofilm, m<sup>2</sup>/h,

$K_L$  – the coefficient of mass transfer of organic contaminants in the liquid film, m/h;

$K_m$  – the saturation constant (halfsaturation) for organic pollutants, BOD(g/m<sup>3</sup>), COD(g/m<sup>3</sup>),

$\mu_m$  – maximum specific growth rate of microorganisms, h<sup>-1</sup>,

$Y = \frac{dX}{dL}$  – the stoichiometric coefficient of the biomass, g/g,

$X$  – the concentration of biomass in the biofilm, BOD(g/m<sup>3</sup>), COD(g/m<sup>3</sup>).

As a result of solving equation (1) with boundary conditions (2) for first order reactions  $R_{L1}$  (4) we get the following relationship for the changes concentration  $L$  on the thickness of the biofilm  $x$ :

$$L(\bar{x}) = L_e \frac{e^{\sqrt{\alpha}(2-\bar{x})} + e^{\sqrt{\alpha}\bar{x}}}{\left(e^{2\sqrt{\alpha}} + 1\right) + \lambda \left(e^{2\sqrt{\alpha}} - 1\right)}, \quad (6)$$

$$\text{where } \alpha = \frac{k \delta^2}{D_L}, \quad \lambda = \frac{\sqrt{k D_L}}{K_L}, \quad \bar{x} = \frac{x}{\delta}.$$

Dependence to determine the concentration of contaminants on the outer surface of the biofilm will get from equation (6) when the value  $\bar{x} = 0$ :

$$L(0) = L_\delta = AL_e, \quad (7)$$

$$\text{where } A = \frac{1 + e^{-\varphi}}{\left(1 + e^{-\varphi}\right) + \lambda \left(1 - e^{-\varphi}\right)}, \quad \varphi = 2\sqrt{\alpha}. \quad (8)$$

On the basis of the dependence (8) for determining the parameter  $A$  built design chart  $A = f(\varphi, \lambda)$  (Fig. 2). Using the dependence (7) equation (6) can be simplified to this:

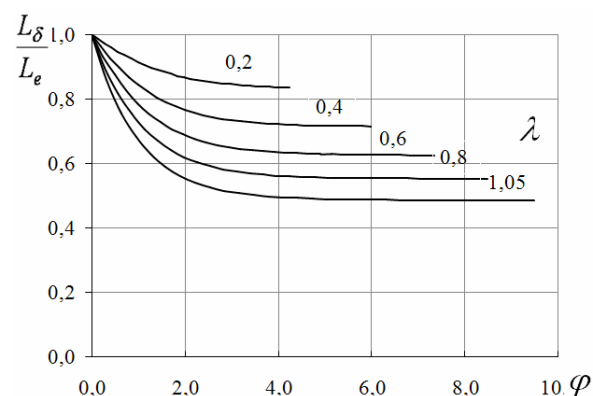

**Fig. 2.** A graph of the dependence  $A = f(\varphi, \lambda)$ . Graph for determining the parameter  $A$  for prismatic download: 1 –  $\delta = 0,0001$  m, 2 –  $\delta = 0,0002$  m, 3 –  $\delta = 0,0003$  m

$$L(\bar{x}) = \frac{\operatorname{ch} \sqrt{\alpha}(1-\bar{x})}{\operatorname{ch} \sqrt{\alpha}} L_{\delta}, \text{ where } \sqrt{\alpha} = \frac{\Phi}{2}. \quad (9)$$

Solving equation (9), we can estimate the efficiency of treatment in this case by establishing a full or partial penetration of OC in the biofilm.

The solution of equation (1) for a zero order reaction  $R_L$  (5) considers the following two cases with different boundary conditions. In the first case, which corresponds to the complete penetration of organic contaminants in the biofilm ( $\beta \geq 1$ ), the solution of equation (1) is performed with the boundary conditions (2), as a result, will receive the following relationship to determine the concentration  $L$  in the biofilm:

$$L(x) = L_e - \frac{w_L}{D_L} \left( \frac{\delta D_L}{K_L} + \delta x - \frac{x^2}{2} \right). \quad (10)$$

The value of concentration at the biofilm surface ( $x=0$ ) will be:

$$L_{\delta} = L_e - \frac{w_L \delta}{K_L}. \quad (11)$$

With (11) equation (10) may be write for further analysis in the form:

$$L(x) = L_{\delta} \left[ 1 - \left( \frac{2x}{\delta \beta^2} - \frac{x^2}{\delta^2 \beta^2} \right) \right], \quad (12)$$

$$\beta = \sqrt{\frac{2L_{\delta} D_L}{w_L \delta^2}} \text{ or } \beta \delta = \sqrt{\frac{2L_{\delta} D_L}{w_L}}. \quad (13)$$

In the second case, which corresponds to the partial penetration of organic contaminants in the biofilm ( $\beta < 1$ ) the solution of equation (1) is provided at  $L=0$  on the border  $x = \delta$  instead of  $\frac{\partial L}{\partial x} = 0$  in the previous case:

$$L(x) = L_{\delta} \left( 1 - \frac{2x}{\beta \delta} - \frac{x^2}{(\beta \delta)^2} \right), \quad (14)$$

$$L_{\delta} = \frac{L_e - \frac{w_L \delta}{K_L}}{\left( 1 - \frac{D_L}{\delta K_L} \right)}. \quad (15)$$

If in many cases the ratio  $\frac{D_L}{\delta K_L} \ll 1$  then in both cases of the value  $\beta$  we can use the dependence (11) that to determine the concentration  $L_{\delta}$ .

To determine fluxes using equation (2) in [11] lists the order of calculation first order kinetics and zero order at the condition of partial and full penetration of organic contaminants in the biofilm. Also, the graph of the concentration profiles for the kinetics order zero in the middle of the biofilm at different values of  $\beta < 1$  and  $\beta > 1$  was provided. Profiles constructed with a constant thickness of the biofilm  $\delta$  and correspond each to a specific value of the concentration  $L_e$  which changes along the height of the filter.

The above solutions are obtained for the kinetics of reactions  $R_L$  of the first and zero orders of magnitude, which corresponds to low and high concentrations of organic contaminants. According to [15], in practical calculations this corresponds to the relations

$$\beta_L = \frac{K_m}{L_0} > 2 \text{ and } \beta_L < 0,25. \text{ In addition in}$$

wastewater treatment by biofilters in some cases we get the ratio  $\beta_L$  within the boundaries of  $0,25 < \beta_L < 2$ . In these cases, the calculations of the reaction kinetics  $R_L$  take the known Monod equation (3). In [15] to determine the concentration of  $L$  in the biofilm, namely on the surface  $L_{\delta}$ , a method for solving equation (1) at given kinetic response of  $R_L$ , according to equation Monod was proposed. The nature and sequence of the proposed iterative method of calculation are given in [11, 13, 15].

In [11] provides guidance for determining flows OC in the case of the reaction kinetics according to the equation Monod.

According to [8] for determining the change in concentration  $L_e$  on height of biofilter is used the equation of conservation of mass of contaminants in the fluid flow of the biofilter in the form of:

$$n_e \frac{\partial L_e}{\partial t} = -Q \frac{\partial L_e}{\partial z} - F_\delta K_L (L_e - L_\delta). \quad (16)$$

In stationary conditions, which occurs very quickly, in a result of solving equations (16) at  $n_e \frac{\partial L_e}{\partial t} = 0$  and when taking into account the dependence (7) for  $L_\delta$  and boundary conditions  $L_e = L_0$  at  $z=0$  for practical calculations for the reaction of the first order we obtain a following dependency:

$$\bar{L}_e = e^{-B\bar{z}} \approx e^{-\tilde{z}}, \quad A_* = K_L F_\delta (1 - A), \quad (17)$$

Here:  $\bar{L}_e = \frac{L_e}{L_0}, \quad \bar{z} = \frac{z}{S}, \quad B = \frac{A_* S}{Q},$

$$\tilde{z} = B\bar{z} = \frac{A_*}{Q} z.$$

To determine the concentration at the outlet of the filter (in filtrate)  $z = S$ , we obtain:

$$L_{eS} = L_0 e^{-\tilde{S}}, \quad B = \tilde{S} = \frac{A_*}{Q} S, \quad (18)$$

and to determine the working height of the filter  $S$  at a known predetermined parameters  $L_0, Q, \varepsilon, L_{eS}$ , and  $A_*$  we obtain:

$$S = \frac{Q}{A_*} \ln \frac{L_0}{L_{eS}}. \quad (19)$$

In following dependencies:

$F_\delta$  – the surface area of biofilm per unit height of the filter, m,  
 $S$  – the working height of the filter, m,  
 $Q$  – flow rate (volumetric flow rate), m<sup>3</sup>/h.

On the basis of dependence (17) in Fig. 3, 4 built estimated graphs

$$\bar{L}_e = \frac{L_e}{L_0} = f(\bar{Q}, \bar{z}) \quad \text{and} \quad \bar{L}_e = \frac{L_e}{L_0} = f(\tilde{z}),$$

where:  $\bar{Q} = \frac{1}{B} = \frac{Q}{A_* S}.$

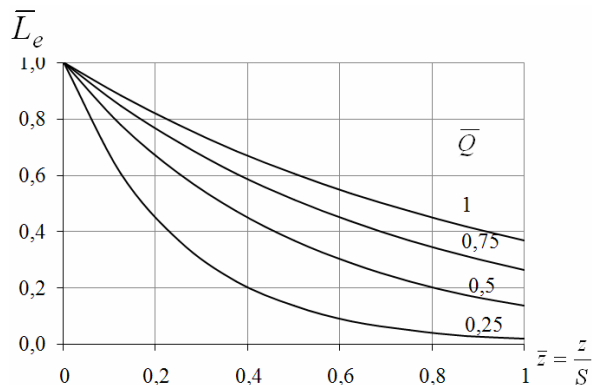

**Fig. 3.** Graph of dependency  $\bar{L}_e = \frac{L_e}{L_0} = f(\bar{Q}, \bar{z})$

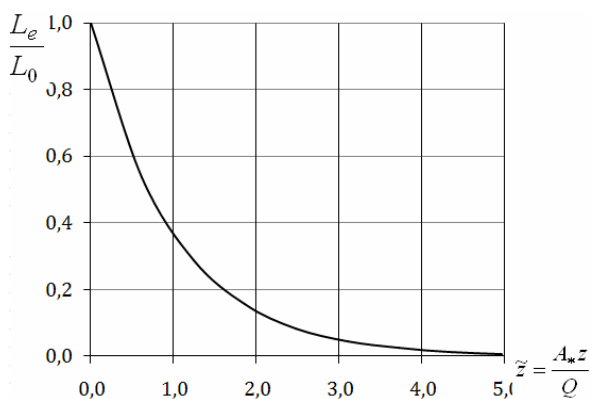

**Fig. 4.** Graph of dependency  $\bar{L}_e = \frac{L_e}{L_0} = f(\tilde{z})$

As a result of solving equation (16) for the zero order reaction (5) with relation (11) for determining the change in concentration  $L_e$  along the height of the filter  $z$  we may receive a dependency:

$$L_e = L_0 - \frac{F_\delta}{Q} w_L \delta z. \quad (20)$$

The concentration at the outlet of the filter ( $z=S$ ) will be:

$$L_e(S) = L_0 - \frac{F_{\delta}}{Q} w_L \delta S, \quad (21)$$

and to determine the height of the filter at a predetermined concentration  $L_e(S)$  we obtaine following equation:

$$S = \frac{Q}{F_{\delta} w_L \delta} (L_0 - L_e(S)). \quad (22)$$

### DISCUSSION OBTAINED RESULTS

Below some of the results of verification and comparative analysis of the proposed models and methods of calculation using existing experimental studies are presented.

Quite reasonable laboratory study on extraction of organic contaminants in sewage treatment biofilter under conditions sufficient supporting of aerobic process by oxygen was carried out in [17]. The reactor (biofilter) was built with PVC 2m high and with a diameter of 0,2 m. Domestic waste water was supplied from below to the central part of the column, air is fed through the holes in the base of the column. As download the elements of waste of polypropylene were used with a diameter of 2,3...2,7 mm, a length of 4...6 mm, the porosity was 0,42.

Concentrations of dissolved oxygen varied from 5.2 to 8.6 mg/l. The researches have shown that these oscillations are not a limiting factor. The researches were carried out for different input concentrations of COD, which varied between  $L_0 = 80...200$  mg/l (0,08...0,2) kg/m<sup>3</sup>. In more detail the methods of researches and their processing are described in [17].

For comparative analysis of the results of theoretical calculations with experimental data has been used the above method of calculation. According to this technique with using given and accepted in the literature source of data the determination of the intermediate parameters ( $A, A_*$ ) was conducted and then on the proposed dependencies were defined changes in the concentration on the

height of the biofilter based on valid reaction rates in the biofilm for this case. In Fig. 5 shows a comparative graph when the input concentration

$L_0 = 0,160$  kg COD/m<sup>3</sup>. Additionally note that when performing calculations to construct the theoretical curve  $L_e = f(z)$  in particular according to [18], the flow rate value was taken  $Q = 0,024$  m<sup>3</sup>/h and the specific surface of the feed material  $F_{\delta n} = 1160$  m<sup>2</sup>/m<sup>3</sup>, and due to the relatively large surface area  $F_{\delta n}$ , according to [14], the thickness of the biofilm adopted  $\delta = 25...30$  microns. Other necessary input data are accepted on the basis of the guidelines described in the known literature. Thus according to [17] the concentration  $L_{en}$  was measured in units of COD and BOD, and the BOD/COD relation was taken of 0,45 for the incoming stream and 0,20 for the effluent (filtrate). On the chart Fig. 5 calculated concentrations are slightly below the experimental one, but there has generally been a good enough match between them.

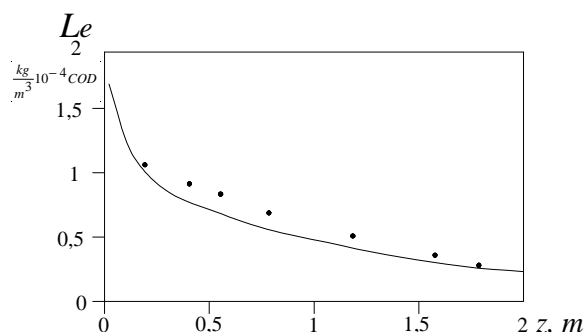

**Fig. 5.** Chart of changes in concentration along the height of the filter  $L_e = f(z)$ .

To assess the dependencies (18) the experimental data was used that given in [18] that allow us to conduct a comparative assessment of theoretical calculations with experimental data. The calculations were performed using dependencies:

$$\bar{L}_e = \frac{L_e}{L_0} = e^{-Bz} = e^{-\tilde{z}},$$

$$B = \frac{A_* S}{Q}, \quad A_* = K_L F_{\delta S} (1 - A),$$

$$F_{\delta S} = F_{\delta} \cdot S, \quad \bar{z} = \frac{z}{S}, \quad (23)$$

which in the determination of the concentration at the outlet of the biofilter (filtrate) take the form:

$$L_{eS} = L_0 e^{-B} = L_0 e^{-\tilde{S}}, \quad B = \tilde{S} = \frac{A_* S}{Q}, \quad (24)$$

here  $L_0$  is the input concentration of organic contamination, mg/l;  
 $S$  – working height of the filter, m;  
 $F_{\delta}$  is the surface area of the feed material per unit height of the filter, m;  
 $K_L$  – coefficient of transfer in the liquid film, m/h;  
 $A$  – the parameter which is determined according to [10].

For the calculation of the parameter  $B$  were taken out the data used in [18] and data taken from the literature. Though the some divergence presents of the experimental data with the calculated, especially for large values  $\bar{L}_{eS}$ , in general, it can be considered a good coincidence of the experimental data with the calculated.

The results of the comparative evaluation is shown in Fig. 6. It shows that although for large values  $\bar{L}_{eS}$  there is some divergence of the experimental data with the calculated, but in general we may count on their good coincidence.

In the literature, in particular [2, 5, 19], on the basis of analysis of existing research results suggested a number of empirical dependences for calculation of parameters of wastewater treatment by biofilters. The basis of this research is a known functional dependence of the concentration of the waste water outlet  $L_{eS}$  (BOD<sub>5</sub>) in depending of a number of factors, which with some modifications depend of the type of load and other factors used by different specialists for treatment [21, 22, 23].

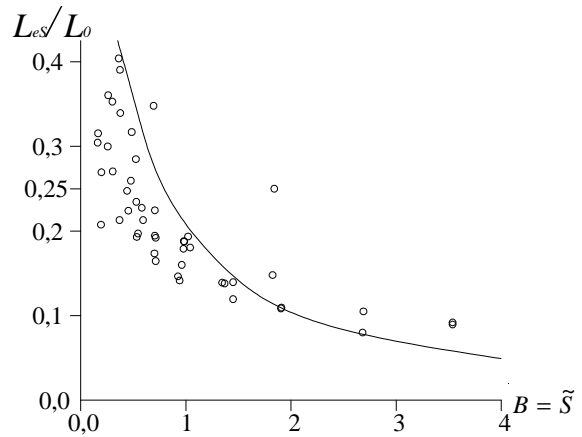

**Fig. 6.** The dependence  $L_{eS}$  on the parameter  $B$  for the gravel biofilter loading, which oxidize urban wastewater:

○ – experimental data, — – estimated curve

Some additions to the calculations.

1. When considering equation (16) the performance of suspended biocenosis in sewage is not taken into account due to its insignificance effect.

2. In accordance with the adopted general model [18], OC receipts from the waste liquid in the biofilm through the liquid film (boundary layer) which is formed on the surface of the biofilm. The analysis showed that it is necessary to consider the OC mass transfer through the boundary layer that implemented in the model in the equation (2) for the flux  $N$  as the boundary conditions on the surface of the biofilm. In [11] there are presented and considered recommendations for the implementation of this equation when solving specific problems.

3. When removing contaminants by attached biocenosis (biofilm) on the biofilters of different designs their concentration along the height of the filter will decrease and according to accepted models will lead to the overall reduction in the thickness of the biofilm on the height of the filter. The proposed model and calculation methods allow to consider this fact in principle. In addition, a numerical comparative analysis of theoretical calculations with experimental data that was carried out shows that the proposed model and methods for calculating, based on the

average weighted constant values of thickness  $\delta$  is sufficiently reliable and adequately describe and show the process of treatment in these cases [1, 4, 13, 15, 23].

4. Extraction of organic contaminants in the biofilm under aerobic conditions is controlled by the flow of oxygen in the biofilm. Organic matter may be present throughout the thickness of the biofilms, but cannot be extracted on the section where oxygen is absent. In biofilters with attached biocenosis (biofilm) at the aerobic process of recycling of organic contaminants it is necessary to provide a dissolved oxygen concentration of at least  $C > 5$  mg/l through the all active thickness of the biofilm [1, 4, 11, 16]. The speed (limiting) of process will be determined by that substrate that penetrates into biofilm at a shallower depth.

## CONCLUSIONS

1. Implementation of the proposed model with appropriate boundary conditions allows to determine the changes in the concentration of contaminants in the biofilm  $L(x)$  and in the filter  $L_e(z)$ .

2. It helps more securely and reliably to justify the technological and constructive parameters of biofilters that confirms the evaluation testes in laboratory and industrial conditions.

3. The comparative results and their analysis suggests that the proposed model and developed on the basis of their calculation methods to describe and show the process of wastewater treatment in trickling biofilters with sufficient adequacy in general.

## REFERENCES

1. **Henze M., M. Van Loosdrecht M. E., Ekama G. A., Brdjanovic D., 2008.** Biological Wastewater Treatment. IWA Publishing, London. 511.
2. **Yakovlev S. V., Voronov Y. B., 2002.** Sewerage and wastewater treatment. M. ACB. 704. (in Russian).
3. **Oleynik A. Y., Kolpakova O. A., 2011.** Calculation of wastewater treatment by biofilters (trickling filters). Problems of watersupply, sewerage and hydraulic. Kyiv, KNUCA, Nr 16, 86-106. (in Ukraine).
4. **Wanner O., N. I. Ebert, Rittman B. E., 2006.** Mathematical Modeling of biofilms. Scientific and Technical report, Nr 18, 208.
5. **Oleynik A. Y., Vasilenko T. V., Rybachenko S. A., Ihab Hamid Ahmad., 2006.** Modeling of processes of purification of domestic wastewater on the filters. Problems of water-supply, sewerage and hydraulic. Kyiv, KNUCA, Nr 7, 85-97. (in Ukraine).
6. **Logan B.E., Hermanowicz S.W., Parker D.S., 1987.** Engineering implications of a new trickling filter model. WPCF, Vol. 39, Nr 12, 1017-1028.
7. **Logan B.E., Hermanowicz S.W., Parker D.S., 1987.** A fundamental model for trickling filter process design. WPCF, Vol. 39, Nr 12, 1029 – 1042.
8. **Oleynik A. Y., Kravchuk A. M., Kolpakova O.A., 2012.** The theoretical justification of wastewater treatment in trickling biofilters. Annals of NASU, Nr 3, 179-183. (in Ukraine).
9. **Kravchuk A. M., Kolpakova O. A., 2011.** Modeling biological processes of removing of organic contaminations on trickling filters. Bulletin ODABA, Odessa, No 13, 120-126. (in Ukraine).
10. **Kravchuk, A. M., Kolpakova O.A., 2014.** Practical recommendations to calculations of wastewater treatment on trickling biofilters. Scientific-technical journal, Kyiv, KNUCA, 2014, Nr 24, 147-155. (in Ukraine).
11. **Oleynik O. Y., Kolpakova O. A., 2014.** Modeling and calculations of the biological treatment on the trickling filters. Ecological safety and make use of nature, Nr 16, 68-86. (in Ukraine).
12. **I. Wimpenny, W. Manz, U. Szewzyk., 2000.** Heterogeneity in biofilms. FEMS Microb. Rev. Vol. 24, 661-671.
13. **Perez I., Piccioreanu C., van Loosdrecht M., 2005.** Modelling biofilm and flosdiffusion processes based on analytical sokution of reaction - diffusion equations. Wat. Res., Vol. 39, 1311-1323.
14. **Lee K. M., Stensel H. D., 1986.** Aeration and substrate utilization in a sparged packed - biofilm reactor. WPCF, Vol. 58, Nr 11, 1065-1073.



15. **Rybachenko S.O., 2011.** Aerobic posttreatment the wastewaters in flooding filters. Dis. Cand. tech. Sciences 05-23-4 Kyiv, KNUCA, 143. (in Ukraine).
16. **Maslun G.S., 2013.** Experimental and industrial approbation of the theoretical calculations of the oxygen regime at posttreatment of the wastewaters by filtering. Ecological safety and make use of nature. Nr 12, 98-113. (in Ukraine).
17. **Mann A. T., Stephenson T., 1997.** Modeling biological aerated filters for wastewater treatment. Wat. Res., Vol. 31, Nr 10, 2443-2448.
18. **Vavilin V.A., 1983.** Nonlinear models of biological purification and self-purification processes in rivers. M. Science. 159. (in Russian).
19. **Yakovlev S.V., Voronov Yu.V., 1982.** Biological filters. M. Building Publishment, 120, (in Russian).
20. **Ерoян S., Fomin S., 2013.** Intensification of biological treatment sewage dairies. Lublin, MOTROL, Vol. 15, Nr 6, 133-140. (in Ukraine).
21. **Karagyaur A., 2013.** The theoretical justification improving sorption treatment of water. Lublin, MOTROL, Vol. 15, Nr 6, 35-42. (in Ukraine).
22. **Ерoян S., Karagyaur A., Pabolkov V., 2013.** Selection of filter loading for multilayer filters with horizontal filtering. Lublin, MOTROL, Vol. 15, No 6, 11-18. (in Ukraine).
23. **Beyenal H., Lewandowski Z., 2005.** Modeling, mass transport and microbial activity in stratified biofilms. Chem. Engin, Scinse, Nr 60, 4337-4348.

ТЕОРЕТИЧЕСКИЕ ИССЛЕДОВАНИЯ  
И РАСЧЕТЫ ОЧИСТКИ СТОЧНЫХ ВОД  
НА КАПЕЛЬНЫХ БИОФИЛЬТРАХ

**Аннотация.** На основе проведенного анализа существующих моделей и методов расчета, предложена общая математическая модель процесса удаления органических загрязнений при аэробной биологической очистке сточных вод на капельных биофильтрах при достаточном обеспечении биоокисления кислородом. Приведены результаты сравнения предложенных теоретических расчетов с экспериментальными данными полученные разными авторами на капельных биофильтрах с разной загрузкой. Как показывают результаты, теоретические расчеты в целом хорошо сопоставляются с экспериментальными данными.

**Ключевые слова:** биофильтр, сточные воды, биологическая пленка, модель, очистка.



## Table of contents

<b>Sergei Bronevitskiy</b>	
Evolution of Reforming of the Civil Construction Industry management system in Ukraine.....	3
<b>Iryna Ustinova</b>	
Principles and strategies of sustainable development of regions.....	13
<b>Yuriy Romanenkov</b>	
Analysis of the predictive properties of Brown's model in the extended domain of the internal parameter.....	27
<b>Volodymyr Skochko</b>	
Morphogenesis and correction of planar rod constructions with a small amount of free nodes.....	35
<b>Igor Solukha</b>	
The influence of longitudinal slope of main road carriage-way on the mass emission from road transport in the atmospheric air.....	45
<b>Igor Solukha</b>	
Intersectional junctions of the main roads in city SRN system (on the basis of Kyiv SRN system).....	53
<b>Viktorija Honta</b>	
Algorithmization tests development of spatial imagination.....	61
<b>Valentina Karpenko</b>	
The effects of mirror reflection from flat and curved translucent structures.....	67
<b>Natalia Bolgarova</b>	
Application of graph theory in the energy efficient architectural design.....	75

<b>Krishna Kayastha</b>	
Development of bell type water well with wide gravel filter.....	83
<b>Mykola Malashevskiy, Polina Berova, Yuriy Mosiychuk</b>	
Proposals to increase of economics effects of landuse residential and public buildings on the example of kyiv.....	95
<b>Olga Petrakovska, Mariia Mykhalova</b>	
The role of land compulsory purchase in engineering and transport infrastructure development.....	103
<b>Vladislav Golubenko</b>	
Ways of comfort radius definition of accessibility for pedestrians to the first service objects.....	111
<b>Iryna Lytvynenko</b>	
Easement procedure and factors which defined it in Ukraine.....	119
<b>Daria Svoboda</b>	
Labor skeleton frame as functional and spatial system of city planning and management.....	127
<b>Iryna Koziatnyk</b>	
The solar component in the context of the inhabited areas microclimate regulation.....	135
<b>Mykhailo Sukach</b>	
Systems of raising deep-water concretions.....	143
<b>Mykola Ruchynskyy, Andriy Zapryvoda</b>	
Defining the basic parameters of vibration settings for sealing horizontal surfaces.....	149
<b>Tetiana Kryvomaz</b>	
The assessment of heavy metal accumulation by myxomycetes.....	157
<b>Olga Kolpakova</b>	
Theoretical studies and calculations of wastewater treatment in trickling biofilters.....	165

## LIST OF THE REVIEWERS

1. Yuriy Abrashkevych
2. Milomir Gasic
3. Mykola Dyomin
4. Svitlana Dubova
5. Iryna Klimova
6. Peter Nigst
7. Mykola Osetrin
8. Olga Petrakovska
9. Alla Pleshkanovska
10. Vitaliy Ploskiy
11. Volodymyr Savyovsky
12. Leonid Scheinich
13. Roman Schultz
14. Oleg Sergiychuk
15. Igor Shostak
16. Michal Styp-Rekovski
17. Iryna Ustinova
18. Olena Voloshkina

Editors of the “MOTROL” magazine of the Commission of Motorization and Power Industry in Agriculture would like to inform both the authors and readers that an agreement was signed with the Interdisciplinary Centre for Mathematical and Computational Modelling at the Warsaw University referred to as “ICM”. Therefore, ICM is the owner and operator of the IT system needed to conduct and support a digital scientific library accessible to users via the Internet called the “ICM Internet Platform”, which ensures the safety of development, storage and retrieval of published materials provided to users. ICM is obliged to put all the articles printed in the “MOTROL” on the ICM Internet Platform. ICM develops metadata, which are then indexed in the “Agro” database.

We are pleased to announce that the magazine “MOTROL – Motorization and Energetics in Agriculture” (ISSN 1730-8658) has undergone a positive evaluation of the IC Journals Master List 2013, the result of which is granting the ICV Index (Index Copernicus Value) 6.56 pts. The resulting score was calculated on the basis of a survey submitted by the Editorial Team as well as assessments made by the professionals from Index Copernicus. We invite you to familiarize yourself with the methodology of IC Journals Master List evaluation: <http://journals.indexcopernicus.com/masterlist.php?q=motrol>.

Impact factor of the “MOTROL” journal according to the Commission of Motorization and Energetics in Agriculture is 2,57 (August 2015).

## GUIDELINES FOR AUTHORS (2015)

The journal publishes the original research papers. The papers (min. 8 pages) should not exceed 12 pages including tables and figures. Acceptance of papers for publication is based on two independent reviews commissioned by the Editor.

Authors are asked to transfer to the Publisher the copyright of their articles as well as written permissions for reproduction of figures and tables from unpublished or copyrighted materials.

### Articles should be submitted electronically to the Editor and fulfill the following formal requirements:

- Clear and grammatically correct script in English,
- Format of popular Windows text editors (A4 size, 12 points Times New Roman font, single interline, left and right margin of 2,5 cm),
- Every page of the paper including the title page, text, references, tables and figures should be numbered,
- SI units should be used.

### Please organize the script in the following order (without subtitles):

Title, Author(s) name (s), Affiliations, Full postal addresses, Corresponding author's e-mail  
Abstract (up to 200 words), Keywords (up to 5 words), Introduction, Materials and Methods, Results, Discussion (a combined Results and Discussion section can also be appropriate), Conclusions (numbered), References, Tables, Figures and their captions

### Note that the following should be observed:

An informative and concise title; Abstract without any undefined abbreviations or unspecified references; No nomenclature (all explanations placed in the text); References cited by the numbered system (max 5 items in one place); Tables and figures (without frames) placed out of the text (after References) and figures additionally prepared in the graphical file format jpg or cdr.

Make sure that the tables do not exceed the printed area of the page. Number them according to their sequence in the text. References to all the tables must be in the text. Do not use vertical lines to separate columns. Capitalize the word 'table' when used with a number, e.g. (Table1).

Number the figures according to their sequence in the text. Identify them at the bottom of line drawings by their number and the name of the author. Special attention should be paid to the lettering of figures – the size of lettering must be big enough to allow reduction (even 10 times). Begin the description of figures with a capital letter and observe the following order, e.g. Time(s), Moisture (% vol), (% m<sup>3</sup>m<sup>-3</sup>) or (% gg<sup>-1</sup>), Thermal conductivity (W m<sup>-1</sup>K<sup>-1</sup>).

Type the captions to all figures on a separate sheet at the end of the manuscript.

Give all the explanations in the figure caption. Drawn text in the figures should be kept to a minimum. Capitalize and abbreviate 'figure' when it is used with a number, e.g. (Fig. 1).

Colour figures will not be printed.

### Make sure that the reference list contains about 30 items. It should be numbered serially and arranged alphabetically by the name of the first author and then others, e.g.

7. Kasaja O., Azarevich G. and Bannel A.N. 2009. Econometric Analysis of Banking Financial Results in Poland. Journal of Academy of Business and Economics (JABE), Vol. IV. Nr 1, 202–210.

References cited in the text should be given in parentheses and include a number e.g. [7].

Any item in the References list that is not in English, French or German should be marked, e.g. (in Italian), (in Polish).

Leave ample space around equations. Subscripts and superscripts have to be clear. Equations should be numbered serially on the right-hand side in parentheses. Capitalize and abbreviate 'equation' when it is used with a number, e.g. Eq. (1). Spell out when it begins a sentence. Symbols for physical quantities in formulae and in the text must be in italics. Algebraic symbols are printed in upright type.

Acknowledgements will be printed after a written permission is sent (by the regular post, on paper) from persons or heads of institutions mentioned by name.